

Integration of Smart Loads for Demand Side Management Using EV in the Medium Voltage Distribution Network

Kaleem Khan Mansoori¹, Anil Kumar Jain²

¹M. Tech Power System Scholar Dept. of Electrical & Electronics, Shri Vaishnav Vidyapeeth Vishwavidyalaya Indore (M.P.) India.

²Assistant Professor Dept. of Electrical & Electronics, Shri Vaishnav Vidyapeeth Vishwavidyalaya Indore (M.P.) India.

Abstract - The energy gap in a power system network may be filled by distributed solar generation. The system's power flow is altered by its high penetration, which also results in significant voltage and frequency fluctuations. Storage is crucial in addressing the solar systems' problems with unpredictability and uncertainty. Electric vehicles (EVs) are applied in this research as a Demand Side Management (DSM) strategy to lessen the impact of solar fluctuations. Three factors—State of Charge (SoC), PV output power, and system voltage—control how an EV battery behaves when acting as a load or source. Using MATLAB/Simulink, various scenarios have been examined on a 2 MW distributed solar generation system integrated with an IEEE-33 bus radial network. The findings demonstrate that by using EVs as a DSM tool, the over/under voltage problems are minimized and excess energy generated is successfully utilized.

Key Words: Smart Load, Electric Vehicle, Medium Voltage Distribution System, Demand Side Management, Solar Generation.

1.INTRODUCTION

Due to the growing concerns about global warming and the fact that transportation is the major source of pollution, clean energy production and electric vehicles (EVs) have caught the interest of numerous sectors and consumers worldwide. As stated by the Internal Economic Development Council (IEDC), the transportation sector uses 70% of the oil used in the USA. Due to their massive populations, China and India have a growing demand for passenger automobiles, and by 2050, the world may have 1.5 billion cars. As a result, it is expected that the need for oil would likewise rise more in the years to come. The manufacture and use of battery-electric vehicles and plug-in hybrid-electric vehicles have increased tremendously in recent years due to their clean operation and independence on oil, and by 2027 they will account for 45% of the market for light vehicles worldwide as Shown in Fig.-1[1]. Tesla automobile company ranked No.1 by selling 9,36,172 unit of EV's in 2021[2]. The benefits of EV's are listed as 5 C's - Clean, Convenient, Clever, Connected, Cost Effective. Other than this EV can play important role in Vehicle to Grid technology.

Using this technique, EVs can function as a load, a distributed energy provider, or a grid network energy storage. The EVs can be charged and thus operate as a load during times of high generation and low demand because the generation and consumption must always balance for a stable power grid. This saved energy can be used for transportation later on or as a source of electricity during periods of high demand and low production [3].

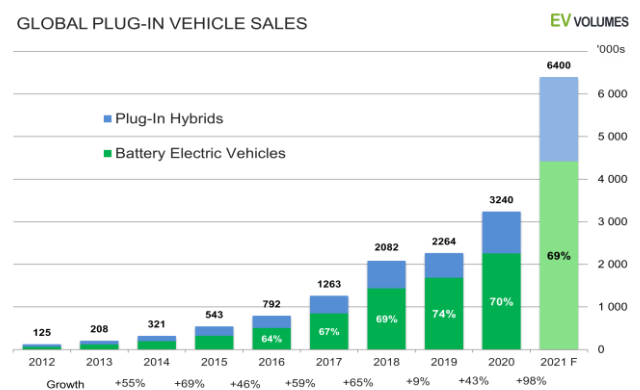

Fig -1: Growth of EV Market (2012-2021)

The solar generation systems have a high level of penetration in the distribution network due to their high potential. Many American businesses, including Energies, Borrego Solar, and Godfrey Hoffman, are now putting solar systems in parking lots to maximize available space [4]. However, due to the uncertain and variable character of distributed solar generation, the higher penetration level of distributed solar generation reshapes the power flow of the distribution system and can cause abrupt swings in system voltages and frequency [5]. By installing EV charging stations in PV parking lots, EVs can act as a peak-shaving or valley-filling tool to improve the stability of the system. As the EV market has developed to the point where they can play a significant role as a Demand Side Management (DSM) tool to mitigate these fluctuations in the system. In this paper, a control algorithm for peak shaving and valley filling in a Vehicle to Grid operation for DSM is proposed. To manage the behavior of the EVs to operate as a load or a source, many parameters

have been employed, including the State of Charge (SoC) of the battery, PV output power, and system voltages.

2.SYSTEM MODELLING

In this work, an IEEE-33 bus radial system, a 12.66 kV medium voltage distribution system, has been employed. A 100MW transformer connects the distribution network to the grid. The system includes 20 PV panels, each with a 100kW capacity, and a 2018 Tesla model S-100D with a 100-kWh capacity has been employed as an EV. Aggregated EVs have a 0.5 MWh capacity, which is used as a DSM tool. Typical SLD of IEEE-33 Bus System is shown in Fig.2.

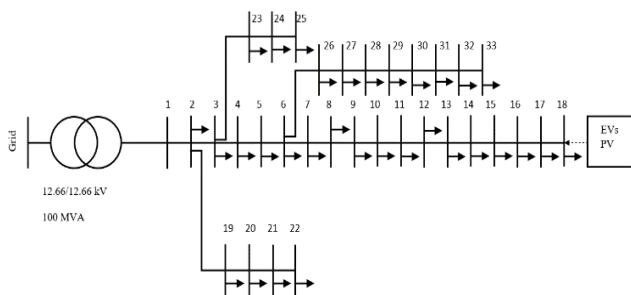

Fig -2: IEEE-33 BUS System

According to the simulation findings for the network without PV and EVs, bus-18 is the crucial bus with the lowest voltage, as shown in Fig 3. As a result, the PV and EV are combined at bus-18 for additional simulations.

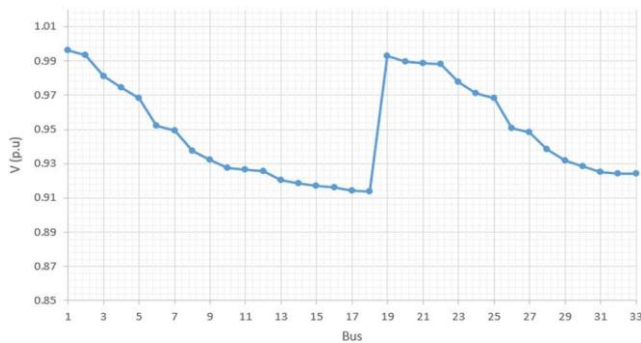

Fig -3: Bus Voltage without PV&EV

1.1 CONTROL ALGORITHM FOR VALLEY FILLING

Fig-4 illustrates the valley filling phenomenon graphically. As shown in Fig-5, this method has been managed by the SoC of the EVs and bus voltage/power from the PV. There are two prerequisites for this operation:

Bus Voltage > 1 (p.u.)

SoC of EV's Batteries < 95%

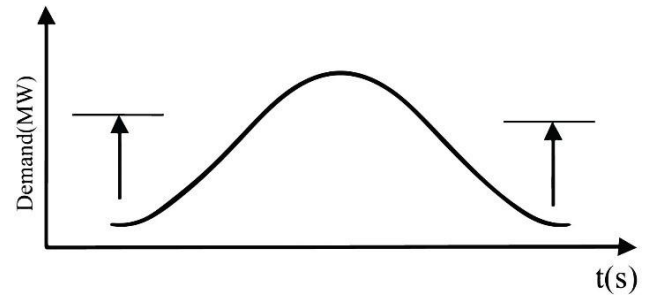

Fig -4: Valley Filling

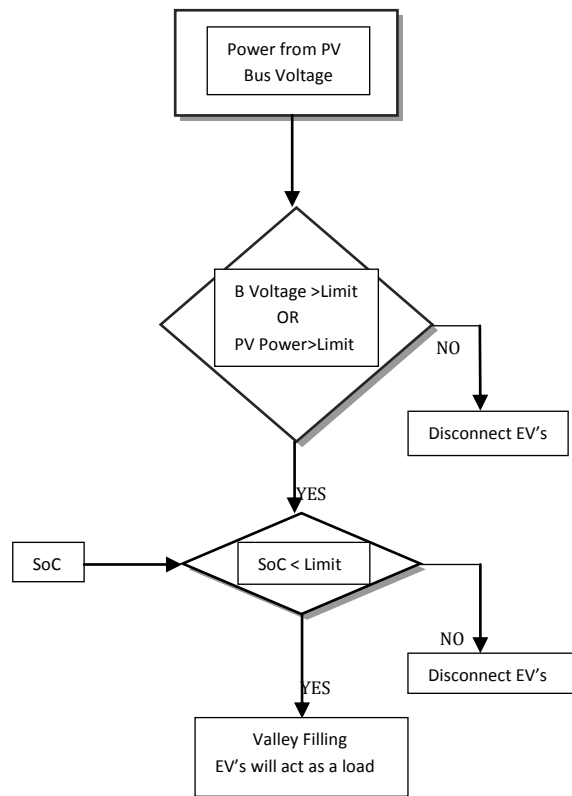

Fig -5: Flow chart for Valley filling

The bus voltages will rise in high generation/low demand scenarios. The bus with which the PV has been integrated will provide the controller with data on a constant basis. If the bus voltage is higher than the nominal value i.e., 1 (p.u.), The controller checks the SoC of the combined EV batteries, and if the second condition is also met, the EVs are then configured to operate as a load and store the extra power produced by the PV.

1.2 CONTROL ALGORITHM FOR PEAK SHAVING

The peak shaving mechanism is shown in Fig.6. The next two prerequisites need to be met for this operation to be carried out as shown in Fig.7.

Bus Voltage < 0.97 (p.u)
SoC of EVs Batteries > 50%

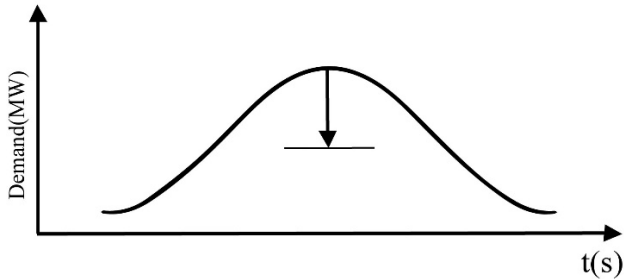

Fig -6: PEAK SHAVING

The bus voltages will decrease in situations with low generation and strong demand. The controller will once more check the SoC of the EV batteries when the voltage dips below the threshold of 5% of nominal voltage, or 0.9 (p.u). If the second condition is confirmed, the EVs will now be made to work as a source and will supply power to the system. The SoC's upper and lower limits won't be exceeded in order to protect the battery's health and safety.

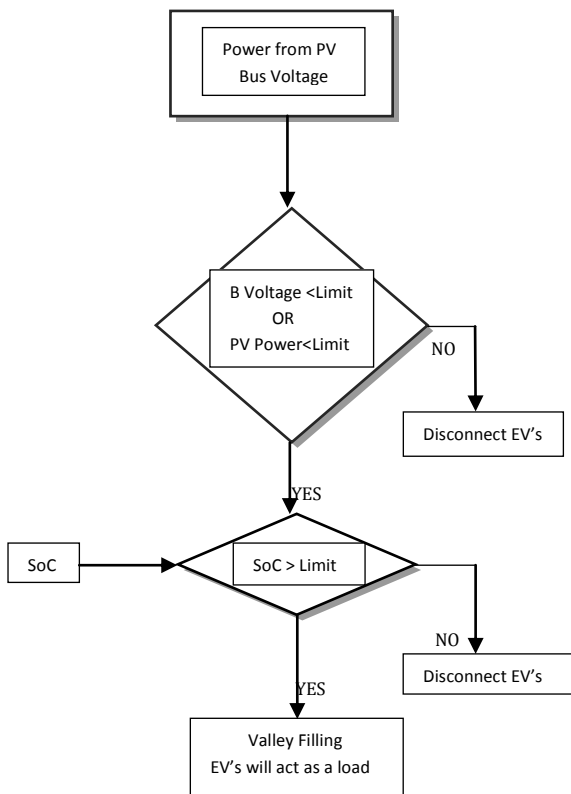
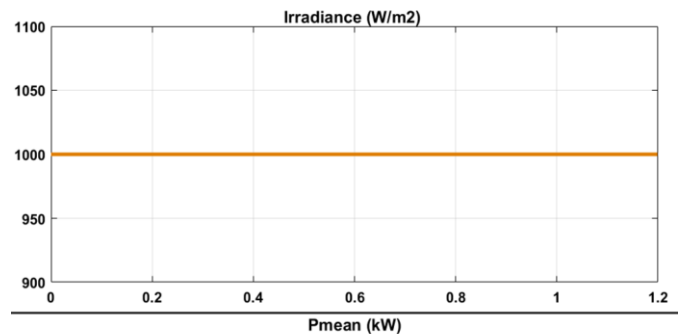

Fig -7: Flow Chart for Peak Shaving

2. SIMULATION, RESULTS & DISCUSSION

20 PV panels, each with a 100-kW capacity, were employed for the simulation. Since an average day's irradiance is between 700 and 800 Wm², a single PV panel typically produces 70 to 80 kW of power at irradiance levels below 1000 Wm². As a result, when the PV panels are exposed to full irradiance, the system may get overwhelmed. An EV is incorporated into the system to support PV penetration in order to solve this issue. Four situations have therefore been addressed in relation to the levels of PV generation with and without EVs.

2.1 Case 1: High PV Generation without EV



Each PV panel is producing around 100 kW of power when the irradiation is 1000 Wm² as shown in Fig.8.

Fig -8: Power & Irradiance from PV

The effect of an increasing voltage profile is particularly notable because the PV is connected to the feeder's important bus 18, which is at the feeder's end. Therefore, near the feeder end, the bus voltage is unable to maintain the permitted voltage limit shown in simulation result Fig. 9. Additionally, the simulation findings demonstrate that the system's head terminal bus voltages are lower than its end bus voltages due to the high power from the PV, which could lead to issues with the system's power flow. Instead of being unidirectional, the power flow is now bidirectional. As a result, changes in the power's direction and magnitude result in oscillations in the system's steady state voltage.

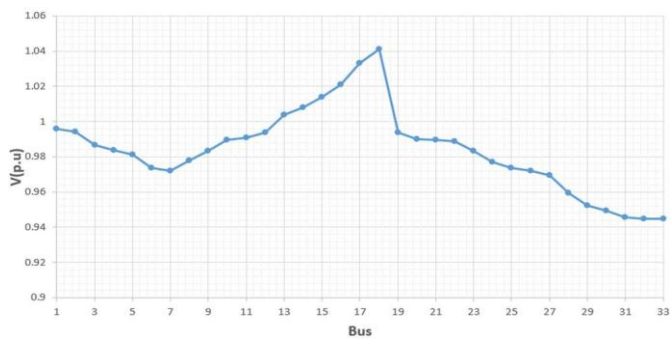

Fig -9: High PV Generation Bus Voltage

2.2 Case 2: High PV Generation with EV

In this instance, EVs are incorporated into the system and used as DSM tools to fix the overvoltage issue. Due to the high-power output of the PV, the EVs will operate as a load and store any excess power produced. As a result, the SoC and voltage of the EV batteries are gradually raised. The presence of a negative current indicates that current is entering the batteries shown in Fig.10.

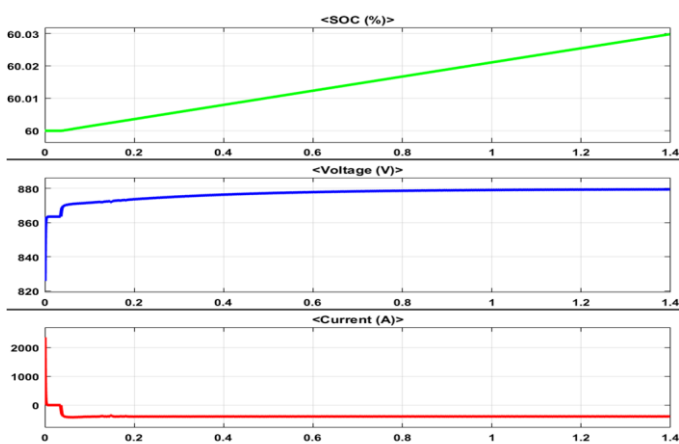

Fig -10: SoC, Current & Voltage of PV Battery

The end line bus voltage will remain within the allowable limit as a result of the EVs' employment as a valley filling tool for DSM shown in Fig.11. The simulation results demonstrate that, in a system with a high penetration of renewable energy, EVs can play a significant role in system stability.

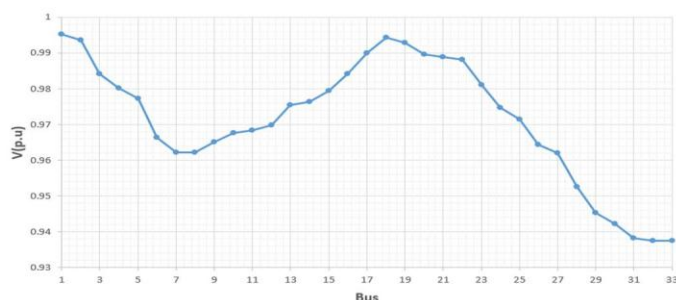

Fig -11: High PV Generation & Bus Voltage with EV

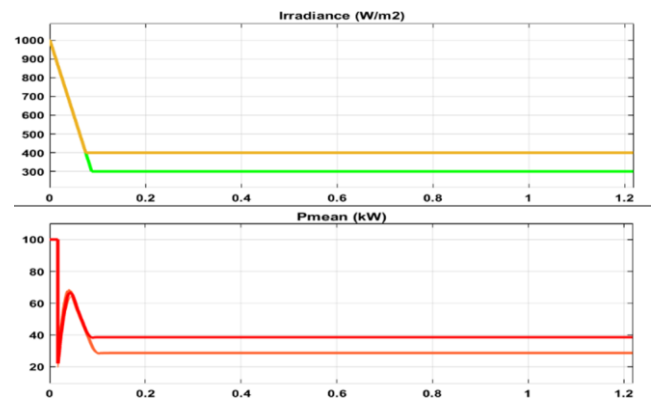

Fig -12: Power & Irradiance from PV

2.3 Case 3: Low PV Generation without EV

PV is intermittent and changeable by nature, just like any other renewable energy source, and is greatly influenced by the weather. The PV panels' solar irradiance is set to a low level in this instance to represent shade. The power from PV is low because of lower solar irradiance because the PV's production is directly tied to solar irradiance shown in Fig.12.

The integration of renewable power in low and medium voltage distribution networks is encouraged by the rising demand for electricity and some environmental restrictions. As discussed earlier, the unpredictable nature of these energy sources may cause severe problem in the system, especially if there is no backup source available. In this case the voltages of the end feeder bus drop to unacceptable limits due to less generation from PV shown in Fig.13.

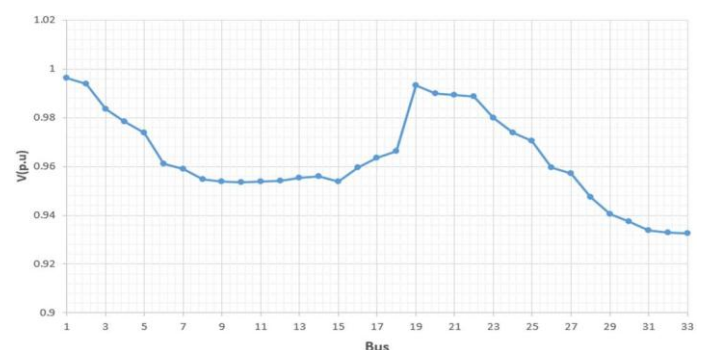

Fig -13: Low PV Generation Bus Voltage

2.4 Case 4: Low PV Generation with EV

In this condition, EVs are added to the system while PV generation is low and the feeder end bus voltage declines as a result. In order to reduce these voltages to a safe level, the controller is now operating the EVs as a source. When EVs operate as a source, the system receives an injection of

current, which lowers the voltage and SoC of the EV batteries shown in simulation results Fig.14

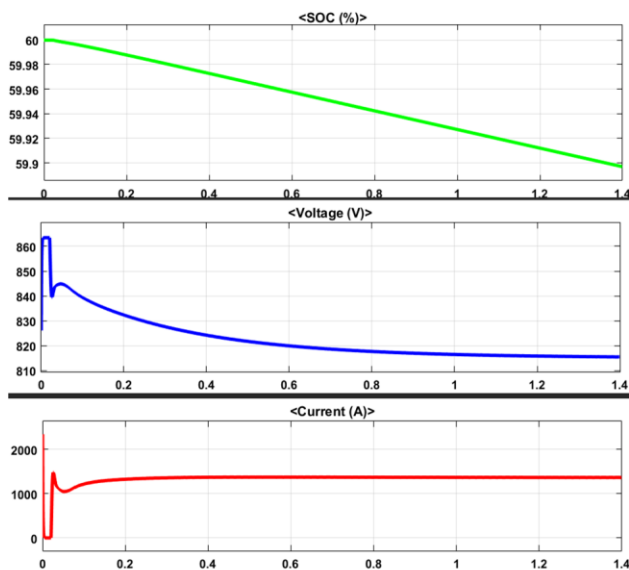

Fig -14: SoC, Current & Voltage of PV Battery

The controller begins feeding power from the battery to the system after the EVs are integrated, acting as a peak shaving tool for DSM. To compensate for the voltage loss, power from the EV batteries is added to the PV power. As a result, the bus voltages are raised to an appropriate level shown in simulation results Fig.15. The high penetration of renewable energy sources is thus made possible without the need for backup reserves, and the installation costs of renewable resources can be reduced, if the number of EVs is raised in the future and distributed across the network.

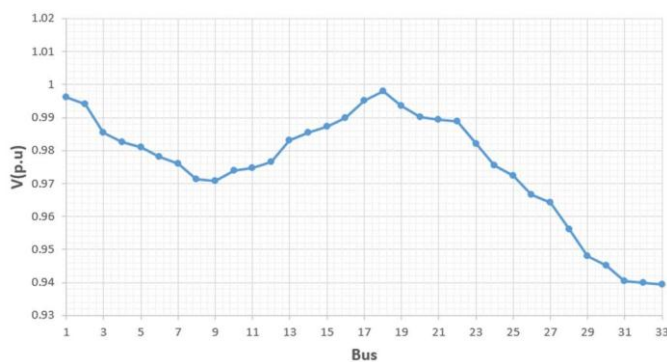

Fig -15: Low PV Generation & Bus Voltage with EV

3. CONCLUSIONS

Improvements in the regulation of charging and discharging of EVs are required in order to fully utilize them for system stability in response to the ongoing exponential increase of global sales and the anticipated penetration of EVs. Using V2G technology, EVs can be made to function as intelligent

loads. In order to support the intermittent and variable character of PV, this research suggests how they can be used as a source for peak shaving and as a load for valley filling. The operation of peak shaving and valley filling control algorithms is explored. Using the valley filling control technique, the end line bus voltages exceed the allowable voltage limits when the power from PV increases. By using EVs as a source, peak shaving control is used to return the voltages to acceptable ranges. The end line bus voltages, on the other hand, tend to drop when PV generation declines, which is countered by employing EVs as a source for peak shaving.

REFERENCES

- [1] By Roland Irlle EV-Volumes.com.
- [2] Mathilde Carlier Statista.com.
- [3] Hassan Butt and Syed Ali Abbas Kazmi 'Integration of EV as Smart Load' conf. paper Nov. 2018
- [4] A. Alghamdi, A. Bahaj, and Y. Wu, "Assessment of Large-Scale Photovoltaic Power Generation from Carport Canopies," *Energies*, vol. 10, no. 5, p. 686, 2017.
- [5] A. Y. Saber and G. K. Venayagamoorthy, "Resource scheduling under uncertainty in a smart grid with renewables and plug-in vehicles," *IEEE Syst. J.*, vol. 6, no. 1, pp. 103–109, 2012.

BIOGRAPHIES



Kaleem Khan Mansoori¹

Scholar M. Tech Power System
Department of Electrical & Electronics
Shri Vaishnav Vidyapeeth
Vishwavidyalaya, Indore M.P.



Anil Kumar Jain²

Assistant Professor
Department of Electrical & Electronics
Shri Vaishnav Vidyapeeth
Vishwavidyalaya, Indore M.P.