

# Early Stage Detection of Alzheimer’s Disease Using Deep Learning

Dnyanada Jalindre<sup>1</sup>, Diksha Gadataranavar<sup>2</sup>, Rushabh Runwal<sup>3</sup>, Ashwin Damam<sup>4</sup>

<sup>1-4</sup>Department of Information Technology, Sinhgad College of Engineering ,SPPU, Pune, India

\*\*\*

**Abstract** – Alzheimer’s disease (AD) is a progressive neurologic disorder that causes the brain to shrink and brain cells to die. There is no treatment that cures AD, however medication may temporarily improve or slow progress of symptoms. Therefore, early stage detection of AD plays a crucial role in preventing its progression. The main objective is to build an end-to-end framework for early detection of AD and medical image classification for various AD stages. We approached the Deep Learning method applying transfer learning pre-trained models such as VGG 16 and ResNet 50 and custom CNN. Four classification metrics have been used - Mild Demented, very mild demented, moderate demented and non demented AD. To make it more convenient for patients and doctors, we have built a web application for remotely analyzing and checking of AD. It also determines the AD stage of the patient based on the AD spectrum. This project combines the MRI data taken from kaggle as a input for classification of AD and its prodromal stages. This experiment shows that VGG16 and ResNet 50 is fine-tuned and has achieved the accuracy of 95 % and 84% respectively. We also built a custom scratch model which gave accuracy of 93% for 2D multi-class AD stage classification.

**Key Words:** Medical image classification , Alzheimer’s disease , Convolutional neural network (CNN) , Deep learning, Transfer learning , Brain MRI

## 1. INTRODUCTION

The Alzheimer’s Association states that AD is the sixth leading cause of death in the United States. About one in three seniors die with AD or another form of dementia. Every 3 seconds, someone in the world develops dementia. AD is the most common form of dementia among older people. Dementia is a brain disorder that seriously affects a person’s ability in remembering things or controlling thought, memory and language. Till date there has been no cure for the disease. The figure below describes the proportion of people affected by AD according to their ages, through which it is comprehensible that people with greater age are more affected.

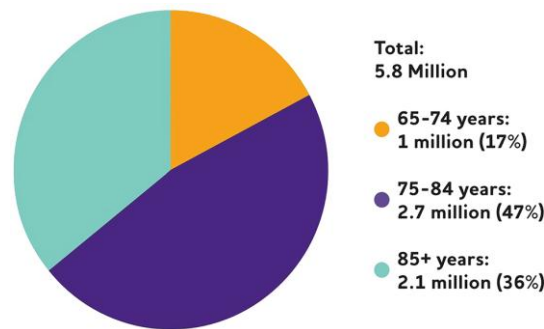

Fig 1[1] A proportion of people affected by AD according to ages in 2020.

Therefore, a great deal of efforts has been made to develop techniques for early detection of AD so that the disease progression can be slowed down. The biggest challenge facing Alzheimer’s experts is that no reliable treatment available for AD so far. Despite this, the current AD therapies can relieve or slow down the progression of symptoms. So, the early detection of AD at its prodromal stage is critical. In this work, we propose a model for AD diagnosis, focused on deep learning approaches and convolutional neural networks for the early stage classification of Alzheimer’s using MRIs. The aim is to correctly classify patients that contain AD and who do not have the disease with high precision. This medical image classification is applied using three methods. The first method is a custom CNN model which consists of 12 layers of Convo 2D and 12 Max Pooling layers. In the second method we have used convolutional neural networks (CNN) and some pre-trained models. CNN is a type of feed forward artificial neural network. It is a CNN that is 16 layers deep; you can load a pre-trained version of the network trained on more than a million images from the ImageNet database. Another model used here is ResNet 50. It is a variant of the ResNet model which has 48 Convolution layers along with 1 MaxPool and 1 Average Pool layer. In addition to that, using the final

qualified architectures, an Alzheimer's checking web application is proposed. It helps doctors and patients to check AD remotely, determines the AD stage, and advises the patient according to its AD stage.

## 2. Literature Review:

### 1. [2] Diagnosis of Alzheimer Disease Using 2D MRI Slices by Convolutional Neural Network

Authors - Fanar E. K. Al-Khuzai, 1 Oguz Bayat, 1 and Adil D. Duru

In this paper, CNN is applied on OASIS-3 dataset in Data provided in MRI by OASIS-3. Proposed architecture contains 5 Conv2D layers and 5 MaxPooling layers along with 2 dense layers. The training data set was 75% and the validation data set was 25%. Precision is very helpful because they want to be confident of forecast, since it tells us how many of the values expected as positive are actually positive. They got an average of 97% of precision and recall.

### 2. Convolution neural network-based Alzheimer's disease classification using hybrid enhanced independent component analysis based segmented gray matter of T2 weighted magnetic resonance imaging with clinical valuation

Authors - S. Basheera and M. S. Sai Ram

In this paper, provided an approach to extract the gray matter from the human brain MRI and make the classification by using CNN. To enhance the voxels, a Gaussian filter is applied, and to remove the irrelevant tissues, the skull stripping algorithm is used. The input to the CNN was segmented gray matter. Clinical valuation was performed using the provided approach. They achieved 90.47% accuracy, 86.66% recall, and 92.59% precision in comparison of their system with physician decision.

### 3.[3] Early Detection of Alzheimer's Disease using Image Processing

Authors : Shrikant Patro and Prof. Nisha V M

In this paper, the implementation is done using image segmentation. The amount of enlargement will classify the patient as Healthy patient, 1st stage AD, 2nd Stage AD, Mild Cognitive impairment cases. Accuracy : 0.9166. Main disadvantage the experiment was performed on only 12 MRI sample of Alzheimer's disease Patient Experiment used the neuroimaging data

### 4.[6] A novel deep learning based multiclass classification method for Alzheimer's disease detection using brain MRI data.

Authors: Islam, J., & Zhang, Y.

In this paper [5], classification is done on the OASIS database. In this approach, a deep CNN network is implemented based on the Inception-V4 network. The model classify MRI images into four classes that are non demented, very mild, mild and moderate Alzheimer's. The accuracy obtained in this approach is 73.75%. This approach is computational costly as the accuracy obtained is very low. Implemented the proposed deep CNN model for Alzheimer's disease detection and classification using Tensorflow [30] and Python and used 70% as training data, 10% as validation data and 20% as test data. The current accuracy of the method is 73.75%.

### 5.[8] A deep learning approach for diagnosis of mild cognitive impairment based on MRI images

Authors - H. T. Gorji and N. Kaabouch

In the paper, the CNN with modified architecture was used to get the high quality features from the brain MRI to classify people into healthy, early mild cognitive impairment (EMCI), or late mild cognitive impairment (LMCI) groups. The results showed the classification between control normal (CN) and LMCI groups in the sagittal view with 94.54 accuracy. The proposed method yielded a 94.54% classification accuracy (94.84% F-score and 99.40% AUC) for CN versus LMCI, 93.96% classification accuracy for the pairs of CN/EMCI (94.25% F-score and 98.80% AUC), and 93.00% classification accuracy for the classification of the pairs of EMCI/LMCI (93.46% F-score and 98.10% AUC) which all of the above mentioned results achieved from the sagittal view.

## 3. Methodology

Early detection of Alzheimer's Disease plays a crucial role in preventing and controlling its progress. Our goal is to propose an end to end model for early detection and classification of stages in Alzheimer's disease. There will be comprehensive explanation of proposed model workflow, preprocessing algorithms and deep learning approaches in the next subsections. The proposed framework comprises five steps, which are as follows :

### Step 1 : DATA ACQUISITION:

The dataset containing all train and test data is collected from Kaggle Alzheimer's dataset in 2D, MRI modality. This consists of 6400 images each segregated into the severity of Alzheimer's. All images were derived with a size of 107 x 238 pixels in 2D format. Both train and test dataset consisted of four directories:

1. Mild Demented - 896 images
2. Very Mild Demented - 2240 images
3. Non Demented - 3200 images
4. Moderate Demented - 64 images

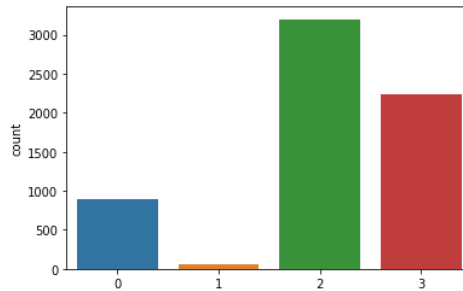

**Fig. 2 Data imported**

**Step 2 : DATA PRE-PROCESSING :** The collected data consisted of imbalance data of different classes . In the dataset of MRIs the train data consisted of cross-section images and test data were longitudinal images , which gave very less accuracy . To overcome this problem we shuffled the train and test data manually .Then split it into train and test at a ratio of 70:30 respectively .This gave us 4480 train images dataset and 1920 test images dataset. The dataset is then processed, normalized, standardized, resized to 224 x 224 pixels and converted to a suitable format.

**Step 3 : MAGNETIC RESONANCE IMAGING (MRI) CLASSIFICATION :** In this step, four stages of AD spectrum (I) Mild Demented , (II) Very mild demented , (III) Nondemented ,and (IV)Moderate Demented AD are multi-classified. This Classification model is done using three methods .First method depends on CNN model which is our custom model. This CNN architecture is built from scratch .Next method is using Transfer learning approach by pre-trained models - VGG16 and RESNET50.

**Step 4 : Evaluation Step:** The three methods and the CNN architectures are evaluated according to performance metrics using precision and recall . We also have a comparison table in the results section.

**Step 5 : Application Step :** Based on the proposed qualified models, an Alzheimer’s checking web application is proposed. It helps doctors and patients to check AD remotely, determines the Alzheimer’s stage of the patient based on the AD spectrum, and advises the patient according to its AD stage. In this web application we can upload any MRI image ,it identifies and displays the stage of AD.

**PROPOSED CLASSIFICATION TECHNIQUES:**

**Convolutional Neural Networks :**

Convolutional Neural Networks are very effective in reducing the number of parameters without losing on the quality of models. Feature extraction, feature reduction, and classification are three essential stages where traditional machine learning methods are composed. By using CNN, there is no need to make the feature extraction process manually. Its initial layers’ weights serve as feature extractors, and their values are improved by iterative learning. CNN gives higher performance than other classifiers.

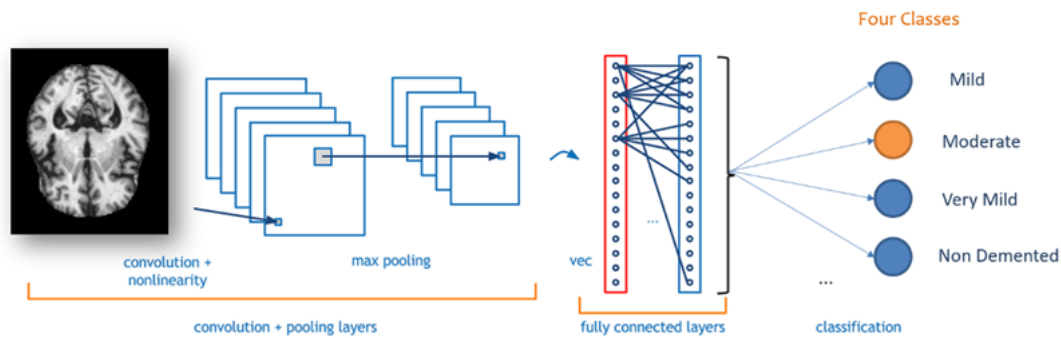

**Fig 3. Convolutional Neural Networks (CNN) Model**

This model consists of four layers of 1. 2D convolutional + Relu layer ,2.Max pooling layer, 3.Flatten layer 4.Dense layer . Convolutional neural networks apply a filter to an input image to create a feature map that summarizes the presence of detected features in the input. Once a feature map is created, we can pass each value in the feature map through a nonlinearity, such as a ReLU The final output of our convolutional layer is a vector. Convolutional layer plays a simple linear transformation over input data , this does not have so much power for complicated task such as image-net classification To overcome this situation ReLU is the effective activation function to prevent that. As Relu is the simplest nonlinear function it is efficient for computation. The mathematical definition of the ReLU function:

$$f(x) = \max(0, x)$$

or expressed as a piece-wise defined function.

$$f(x) = \begin{cases} 1 & \text{if } x > 0 \\ 0 & \text{otherwise} \end{cases}$$

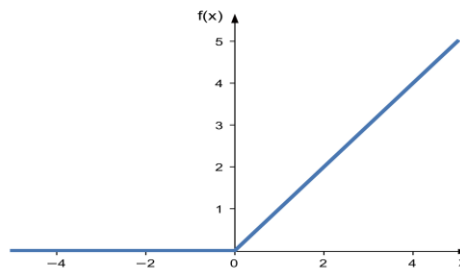

**Fig 4.[4] Relu**

Next Max-Pooling Layer is added to a model . Max-pooling reduces the dimensionality of images by reducing the number of pixels in the output from the previous convolutional layer. Max pooling extracts the most important features like edges whereas, average pooling extracts features so smoothly. Max pooling is better for extracting the extreme features. It helps in Dimension Reduction and Rotational/Position Invariance Feature Extraction .Now next we added a Flatten layer to convert the output of the convolutional part of the CNN into a 1D feature vector . This operation is called flattening. It receives the output of the convolutional layers, then it flattens all its structure to create a single long feature vector to be used by the dense layer for the final classification. Next at last stage of model we add dense and dropout layer .A Dense Layer is used to classify image based on output from convolutional layers. A dense layer represents a matrix vector multiplication. So we get a m -dimensional vector as output. A dense layer thus is used to change the dimensions of our vector.

**VGG16** : VGG is an acronym of Visual Geometry Group, which is a deep convolutional neural network model that secured 2nd place in the ILSVRC-2014 competition with 92.7% classification accuracy .This model investigates the depth of layers with a very small convolutional filter size (3 × 3) to deal with large-scale images. The structure of VGG16 is described as

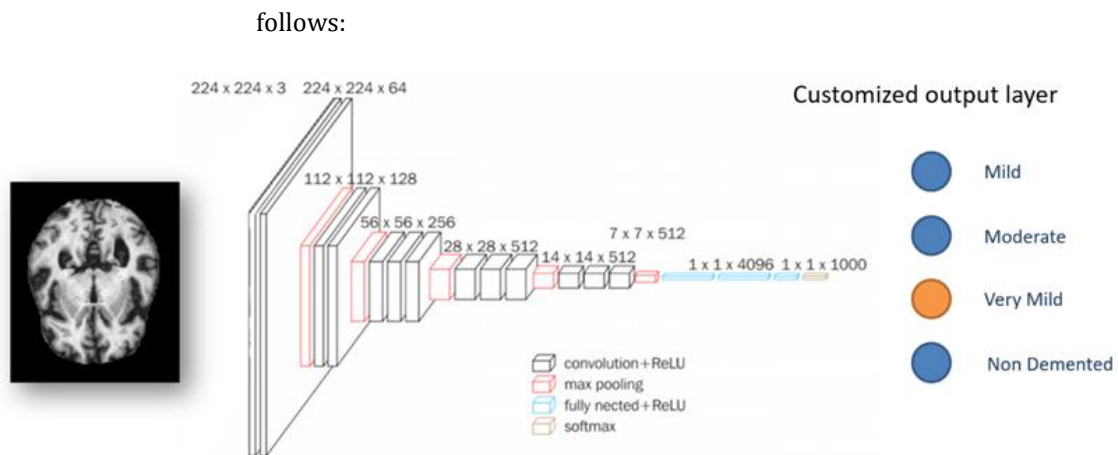

Fig 5. Approach of using VGG

VGG16 in our model is composed of 13 convolutional layers, 5 max-pooling layers, and 3 fully connected layers. Therefore, the number of layers having tunable parameters is 16 (13 convolutional layers and 3 fully connected layers). This is why the model name is VGG16. The number of filters in the first block is 64, then this number is doubled in the later blocks until it reaches 512. This model is finished by two fully connected hidden layers and one output layer. The output layer consists of 1000 neurons corresponding to the number of categories of the Imagenet dataset.

**ResNet50 :** For research purpose we wanted to observe the performance of ResNet50 and compare it with VGG16 and CNN. ResNet50 is used to build networks compared to other plain networks and simultaneously find a optimized number of layers to negate the vanishing gradient problem. The architecture of ResNet50 has **5 stages** as shown in the diagram below. Consider the input size as 224 x 224 x 3 so every ResNet architecture performs the initial convolution and max-pooling using 7x7 and 3x3 kernel sizes respectively. Afterwards, Stage 1 of the network starts and it has 3 Residual blocks containing 3 layers each. The size of kernels used to perform the convolution operation in all 3 layers of the block of stage 1 are 64, 64 and 128 respectively. We get the size of input reduced to half. As we progress from one stage to another, the channel width is doubled and the size of the input is reduced to half. Finally, the network has an Average Pooling layer followed by a fully connected layer having 1000 neurons.

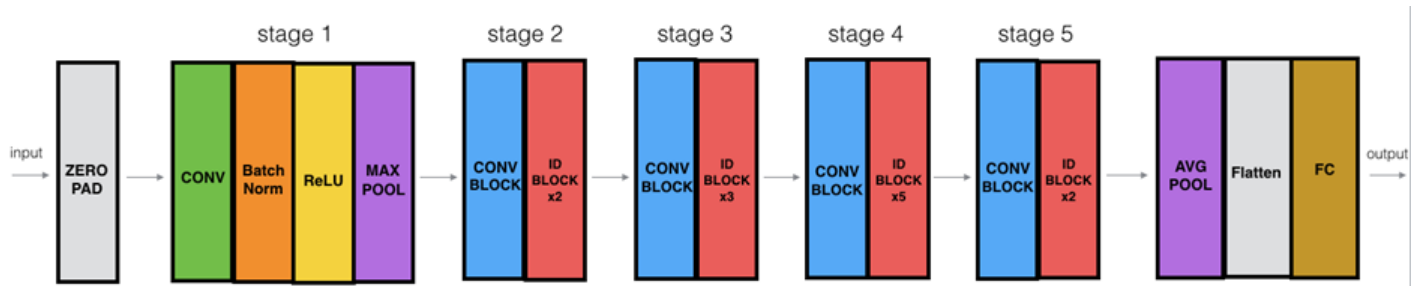

Fig 6[5] . ResNet50 architecture

#### 4. Experimental Results And Model Evaluation :

The proposed models take into consideration different conditions. The experimental results are analyzed in terms of six performance metrics: accuracy, loss, confusion matrix, F1 Score, recall, precession. We have analyzed them sequentially , Following are confusion matrixes of CNN , VGG16 , ResNet50 for comparison respectively .

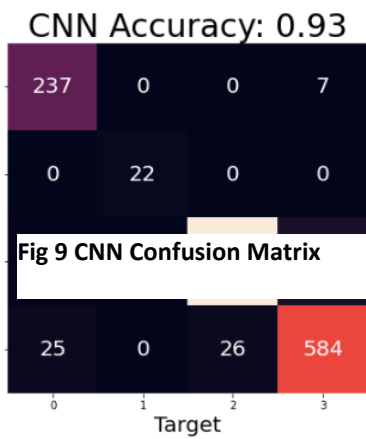

Fig 9 CNN Confusion Matrix

So we

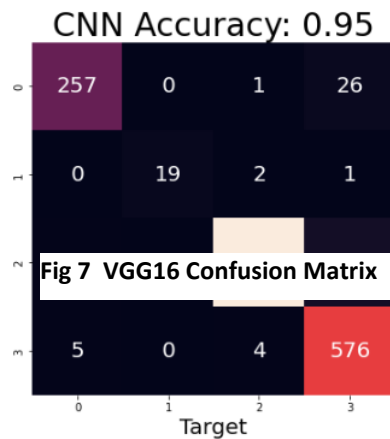

Fig 7 VGG16 Confusion Matrix

as

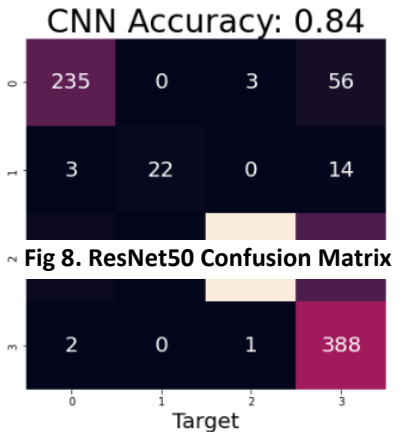

Fig 8. ResNet50 Confusion Matrix

observe that proposed transfer learning model VGG16 achieves highest accuracy of 95%.The custom CNN model achieved second highest accuracy of 93% .The proposed ResNet50 model achieves 84% accuracy. For multi-class and binary medical image classification methods applied, we propose simple CNN architecture models called Custom CNN,VGG16 ,ResNet 50 . According to the accuracy metric, these models will be evaluated by comparing their performance to other state-of-the-art models, as shown in Table below

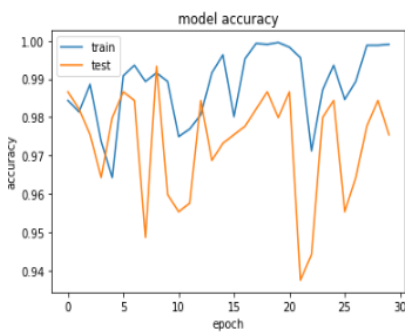

Fig. 10 Training and validation accuracy of CNN

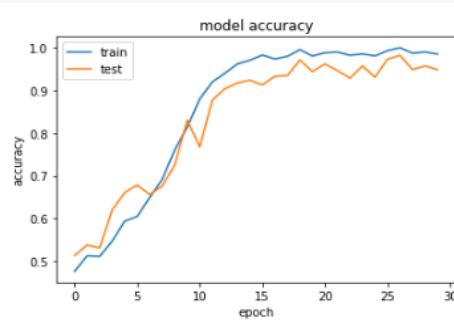

Fig. 11 Training and validation accuracy of VGG16

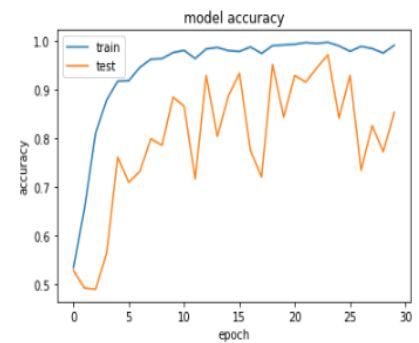

Fig 12. Training and validation accuracy of ResNet 50

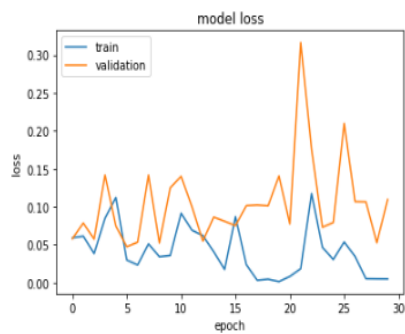

Figure 13.Training and validation loss of VGG16

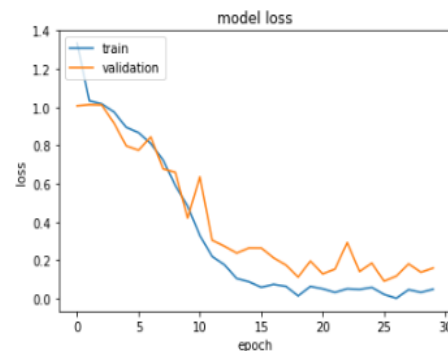

Figure 14 Training and validation loss of CNN

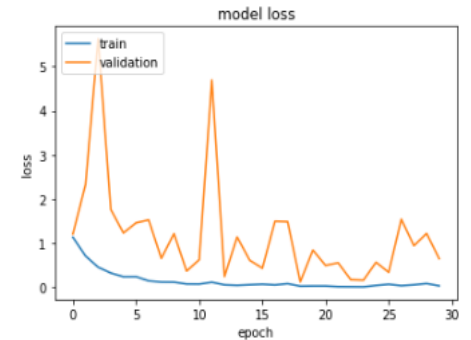

Figure 15 Training and validation loss of ResNet50

Therefore, from the empirical results, it is proved that the proposed architectures are suitable simple structures that reduce computational complexity, memory requirements, over fitting, and provide manageable time. They also achieve very promising accuracy for binary and multi-class classification. In Fig.10 , Fig.11 , Fig.12 we have compared Training and validation accuracy with respect to train and test data for CNN ,VGG16 and ResNet 50 models . In Fig.13 , Fig.14 , Fig.15 we have compared Training and validation loss with respect to train and test data for CNN ,VGG16 and ResNet 50 models .



Comparing Precision , Recall and F1 Score for the proposed models - CNN ,VGG16 and ResNet50 model:

Models	Precision	Recall	F1 Score
Custom CNN Model	93%	93%	93%
VGG16	95 %	95%	95%
ResNet 50	87%	84%	83%

Fig. 16 Comparison of the performance metrics of the three proposed models (CNN model,VGG16 model,ResNet50 model )

**Alzheimer Checking Web Service :**

Because of the COVID-19 pandemic, it is difficult for people to go to hospitals periodically to avoid gatherings and infections. Thus, a web service based on the proposed CNN architectures is established. It aims to support patients and doctors in diagnosing and checking Alzheimer’s disease remotely by sharing their MRIs. It also determines in which Alzheimer’s stage the patient suffers from based on the AD spectrum. First we have to open the web application and choose the MRI document from our local PC . After the patient uploads the MRI image, the program classifies the MRI as belonging to one of the phases of Alzheimer’s disease ((I) Mild Demented, (II) Very mild demented, (III) Non demented, and (IV)Moderate Demented ).After clicking Predict the screen displays the Alzheimer’s Stage . Moreover, the application guides the patient with advice relied on the classified stage.

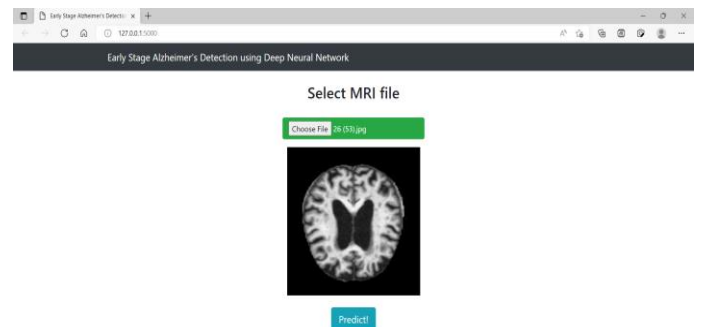
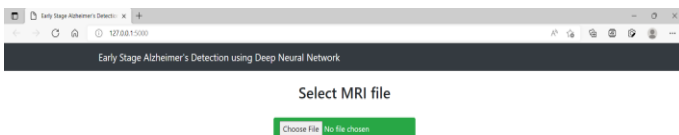

**Figure 17. Upload the document in web page**

**Figure 18 Click on the predict**

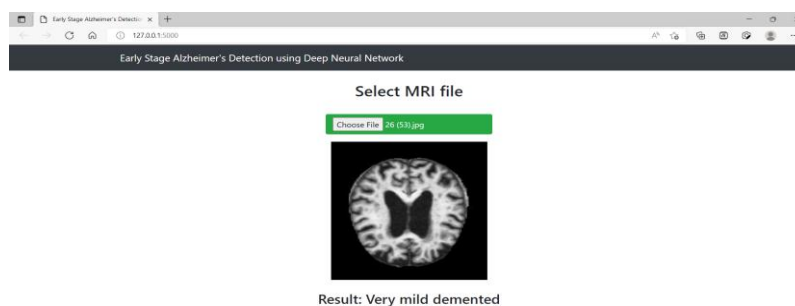

**Figure 19 Displays the results**

### Future Scope :

1. We can host the web service and make it easy accessible .
2. Make an Chatbot with the web application for direct consultation .
3. Add various features like booking appointment with doctor, checking nearby hospitals ,symptoms checker, easy access with your medical records.
4. Add remainder and notifications.
5. Doctor and patient conversation using video conferencing .

### Conclusion:

In this report we studied various deep neural networks and we will use them to diagnose Alzheimer's disease in its early stage . We reviewed the two convolutional neural networks pre-trained on the ImageNet dataset thoroughly and a custom CNN model built from scratch. As we observed the experimental results ,VGG16 achieves the highest accuracy of 95% . We will be using VGG16 as our base model because it has best performance. So, the VGG19 model is fine-tuned and used for multi-class medical image classifications. Scratch model and Resnet50 also achieve the promising accuracy of 93% and 84% respectively. The experimental results prove that the proposed architectures are suitable simple structures that reduce computational complexity, memory requirements, over fitting, and provide manageable. Moreover, Alzheimer's checking web application is proposed using the final qualified proposed architectures. It helps doctors and patients to check AD remotely, determines the Alzheimer's stage of the patient based on the AD spectrum, and advises the patient according to its AD stage.

### REFERENCES

- [1] Hadeer A. Helaly<sup>1,2</sup> · Mahmoud Badawy<sup>2,3</sup> · Amira Y. Haikal<sup>2</sup> .Title "Deep Learning Approach for Early Detection of Alzheimer's Disease" Springer (ISSUE: September 2021), <https://doi.org/10.1007/s12559-021-09946-2>.
- [2] Fanar E. K. Al-Khuzai , 1 Oguz Bayat , 1 and Adil D. Duru "Diagnosis of Alzheimer Disease Using 2D MRI Slices by Convolutional Neural Network" Hindawi Applied Bionics and Biomechanics Volume 2021, Article ID 6690539, 9 pages
- [3] Shrikant Patro and Prof. Nisha V M "Early Detection of Alzheimer's Disease using Image Processing", IJERT ISSN: 2278-0181 , Vol. 8 Issue 05, May-2019.
- [4] Relu Function : <https://sebastianraschka.com/faq/docs/relu-derivative.html>.
- [5] ResNet Architecture [https://www.reddit.com/r/deeplearning/comments/hip427/what\\_are\\_the\\_50\\_layers\\_of\\_resnet50\\_i\\_know\\_that/](https://www.reddit.com/r/deeplearning/comments/hip427/what_are_the_50_layers_of_resnet50_i_know_that/).
- [6] Islam, J., & Zhang, Y. (2017). A novel deep learning based multiclass classification method for Alzheimer's disease detection using brain MRI data. In International conference on brain informatics (pp. 213–222). Cham: Springer.
- [7] ResNet Architecture : <https://cv-tricks.com/keras/understand-implement-resnets/>.
- [8] H. T. Gorji and N. Kaabouch, "A deep learning approach for diagnosis of mild cognitive impairment based on MRI images," Brain Sciences, vol. 9, no. 9, pp. 217–231, 2019

### BIOGRAPHIES



**Dnyanada Jalindre** is a B.E. Student at the Department of Information Technology, Sinhgad College Of Engineering, SPPU, Pune.





**Diksha Gadataranavar** is a B.E. Student at the Department of Information Technology, Sinhgad College Of Engineering, SPPU, Pune.



**Rushabh Runwal** is a B.E. Student at the Department of Information Technology, Sinhgad College Of Engineering, SPPU, Pune.



**Ashwin Damam** is a B.E. Student at the Department Of Information Technology, Sinhgad College of Engineering, SPPU, Pune.