

Design and Analysis of Cylinder Fins

Chaitanya S Kannao¹, Dr. Sanjay S Bhagwat²

¹M.E (CAD/CAM) Department of Mechanical Engineering
Babasaheb Naik College of Engineering , Pusad 445204, India

²Associate Professor Department of Mechanical Engineering
Babasaheb Naik College of Engineering , Pusad 445204, India

Abstract - The Engine cylinder is one of the essential engine components, which is subjected to over-the-top temperature differences and thermal stresses. In air cooled I.C engines, extended surfaces called fins are provided at the periphery of engine cylinder to increase heat transfer rate. Fins are set on the surface of the cylinder to improve the quantity of heat exchange by convection. The cooling mechanism of the air-cooled engine is mostly dependent on the design of the fin on the cylinder. Cooling fins are used to increase the heat transfer rate of specified surfaces. The fin parameters like length, pitch, thickness, fin number, wideness and materials are having great influence on heat transfer rates, so if the sole purpose is to increase heat transfer rate, then the shape of fin will play a crucial role in increasing heat loss capacity of the cylinder block of the same size and materials. First of all, an analytical calculation were made to find the amount of heat loss to through fins theoretically. The inner wall temperature was taken approximately 2000C which is required for maintaining the cycle of the engine. Outer wall temperature and fin surface temperature were calculated theoretically & computationally. From literature survey circular & wavy shape fins are considered for the analysis. Also, aluminium, aluminium 6061 and aluminium 2014 are selected as material for comparative analysis with above mentioned shapes. CAD models were built using SOLIDWORKS 2020 and analysis of fins were carried out in ANSYS 2022 Student version. The results found from the analysis shows that the improved performance of wavy fins is obtained as compared to the circular fins.

1. INTRODUCTION

The cooling of hot surfaces by means of metal fins can be achieved by two ways i.e., one involving the convection of heat from the fin surfaces by air stream and the other by conduction of heat through the fins to fin surface. The rate at which heat is conveyed from a fin surface by air stream is usually expressed as a surface heat transfer coefficient. Almost all modern motorcycle engines use liquid-cooling except for motorbike engines. Although it is more difficult for air-cooling than liquid-cooling to effectively cool an engine, construction of an air-cooled engine is simpler. In an air-cooled engine, the fins conduct heat away from the cylinder and transfer it to the air. Therefore, it is important for air-cooled engines to utilize fin for effective engine

cooling and uniform temperature in the circumference of the cylinder. We know that in case of IC engines, combustion of air fuel mixture takes place inside the engine cylinder and hot gasses are generated inside the cylinder of two-wheeler temperature is 300^o to 1000^o C. Due to this high temperature the gasket or film are burned, fins help to reduce the temperature around 180^o – 250^o C. The design of metal fins increases the surface area of the engine and thus improves the cooling rate through convection. Too much cooling of the cylinder reduces its thermal efficiency, so the object of the cooling system is to keep the engine running at its most efficient operating temperature. It is to be noted that the engine is quite inefficient when it is cold and hence the cooling system is designed in such a way that it prevents cooling when the engine is warming up and till it attains to maximum efficient operating temperature, then it starts cooling. The design of the air-cooled engine involves many aspects of engineering considerations, such as cooling rate, total mass, geometry restrictions.

1.1 Necessity of Cooling System

Internal combustion engines reject most of the heat content of the fuel which they burn in that part which they turn into power. The importance of the heat which is rejected is often not recognized, but this heat is the cause of most engine troubles and is the basic determinant of the rating of an engine. Part of the heat which is rejected by the engine is carried away by the exhaust gas and the remaining must pass through the metallic walls which surround the combustion chamber that is, the piston, the cylinder walls, the piston rings, injector, spark plugs, and exhaust passages. The heat which is rejected through the metallic parts raises their temperatures and in passing through these parts expands, weakens, and stresses them. Each part has a limited capacity to flow heat through itself and in general more drastic cooling creates internal stresses in the materials. Thus, one of the principal objectives in the development of any internal combustion engine is to obtain the highest possible thermal efficiency to reduce the flow of heat through the engine parts.

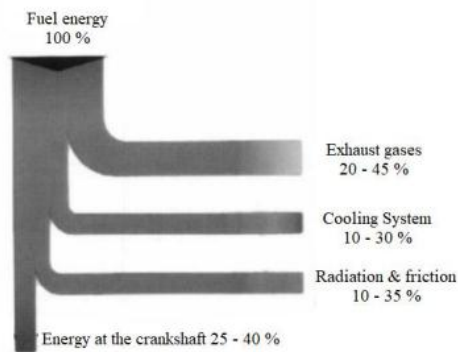

Fig. 1.1 : Energy Balance of IC Engine

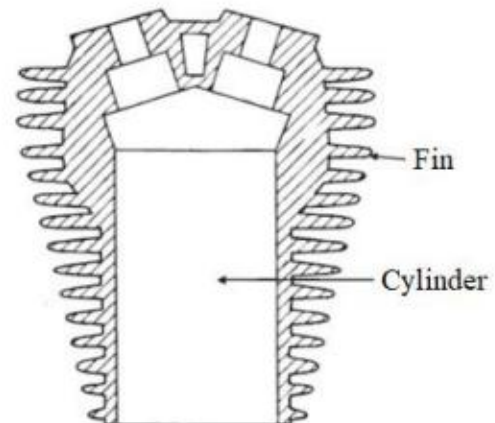

Fig. 1.2 : Cylinder Fins

Necessity of cooling system in I.C engines is all the heat created by the ignition of fuel in the engine chambers isn't changed over into valuable power at the crankshaft. Valuable work at the crank shaft = 25 - 40 % Loss to the cylinder walls = 10 - 30 % Loss in exhaust gasses = 20 - 45 % Loss in friction & radiation = 10 - 35%. It is seen that the amount of heat given to the chamber dividers is impressive and if this heat isn't expelled from the chambers, it would bring about the pre-ignition of the charge. Moreover, the oil would likewise consume with extreme heat, along these lines causing the seizing of the cylinder. Abundance heating will likewise harm the chamber material. To avoid thermal breakdown of the lubricating oil, it is necessary to keep the cylinder wall temperatures in the range of 180°-200°C. As lubrication technology improves with the quality of oils, than maximum allowable wall temperature can be maintained.

1.2 Air Cooling System

Air cooled system is generally used in small engines say up to 15-20 kW and in aero-plane engines. In this system fins or extended surfaces are provided on the cylinder walls, cylinder head, etc. Heat generated due to combustion in the engine cylinder will be conducted to the fins and when the air flows over the fins, heat will be dissipated to air. The amount of heat dissipated to air depends upon:

- Amount of air flowing through the fins.
- Fin surface area.
- Thermal conductivity of metal used for fins

1.2.1 Advantages

Following are the advantages of air-cooled system:

- Radiator/pump is absent hence the system is light.
- In the case of a water-cooling system there are leakages, but in case of air-cooling system, there are no leakages.
- Coolant and antifreeze solutions are not required.
- This system is suitable in cold climates, as water may get frizzed at lower temperature.

1.2.2 Disadvantages

- Comparatively it is less efficient.
- It can be applied only to the small and medium engines.

1.3 Cooling Fin

A fin is a surface that extends from an object to increase the rate of heat transfer to or from the environment by increasing convection. The amount of conduction, convection, and radiation of an object determines the amount of heat it transfers. Increasing the temperature difference between the object and the environment, increasing the convection heat transfer coefficient, or increasing the surface area of the object increases the heat transfer. Sometimes it is not economical, or it is not feasible to change the first two options. Adding a fin to the object, however, increases the surface area and can sometimes be economical solution to heat transfer problems. The surface area over the cylinder gets bigger by means of fins. These fins are either cast as an integral part of the cylinder or different finned barrels are placed over the cylinder barrel. Sometimes particularly in aero engines, the fins are machined from the forged cylinder blanks. As a rule, the fins are usually made of about the cylinder wall thickness at their

roots, tapering down to about one-half the root thickness. The length of the fins varies from one-quarter to one-third of the cylinder diameter. The distance between the two fin centers is about one-quarter to one-third of their length. The total length of the finned cylinder barrel is from 1 to 1½ times the cylinder bore.

1.4 Types of Fins

According to heat transforming necessity fins can be selected. The various types of fins are as shown in fig 1.3

- Parabolic fin
- Cylindrical fin
- Triangular fin
- Rectangular fin
- Trapezoidal fin

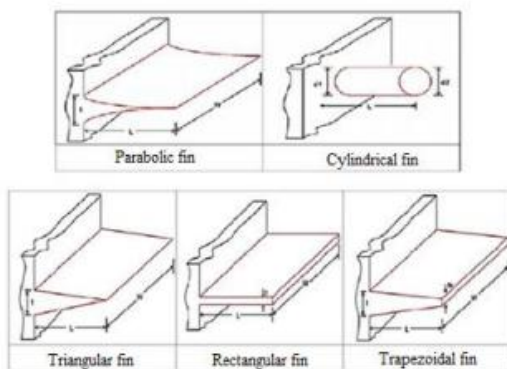

Fig. 1.3 : Different Types of Fins

1.5 Air-Cooling Mechanism

The cooling mechanism of the air-cooled engine is mostly dependent on the design of fin cylinder head and block. Fig.1.4, shows the overall heat transfer process from gasses within the cylinder through the combustion chamber wall by conduction mode and finned surfaces to the external airflow by convection mode. The conduction heat transfer from inner wall to fin surface is given as^[7]

$$Q_1 = h_c (T_g - T_{f,fin}) \dots (1)$$

Thermal conduction is a mechanism of heat propagation from a region of higher temperature to a region of lower temperature within medium (solid, liquid or gaseous) or between different mediums in direct physical contact. Conduction does not involve any movement of microscopic portions of matter relative to one another. The thermal energy may be transferred by means of electrons which are free to move through the lattice structure of the material. In

addition, or alternatively, it may be transferred as irrotational energy in the lattice structure of the material. Thermal conduction is essential due to random molecular motion; the concept is termed as microform of heat transfer and usually referred to as diffusion of energy. The convection heat transfer from fin surface to atmosphere air by free and forced air is given as

$$Q_1 = h_c (T_{f,fin} - T_a) \dots (2)$$

Thermal convection is the process of energy transport affected by the circulation or mixing of a fluid medium. Convection is possible only in a fluid medium and is directly linked with the transport of the medium itself. Macroscopic particles of a fluid moving in space cause the heat exchange, and thus convection constitutes the macro form of the heat transfer. The effectiveness of heat transfer by convection depends largely upon the mixing motion of fluid. With respect to origin, there are two types of convection, namely free convection and forced convection. In natural convection flow of fluid is caused by density difference while in forced convection fluid flow is caused by Pump.

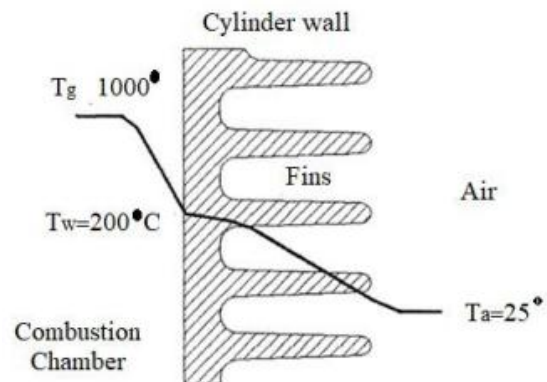

Fig. 1.4 : Air cooling Mechanism^[7]

This project deals with design and analysis of various types of fins with different material i.e. Aluminium, Aluminium 6061 & Aluminium 2014.

2 LITERATURE REVIEW

Biermann Arnold E. & Pinkel Benjamin (1934),^[1] presented fin dimensions for maximum heat transfer with a given amount of material for variety of conditions for air flow and metals. Concluded that the value of surface heat transfer coefficient varies mainly with air velocity and space between them. The effect of other fin dimensions is small. They used the theoretical formula for calculating the heat dissipated from finned cylinder checks fairly closely the heat dissipation experiment.

Cramer Robert (1967)^[2] developed methods of calculating the heat rejection of internal combustion engines so that these quantities can be used in selecting radiators and oil

coolers. The importance of heat which is rejected, though often not recognized, is that it is the source of most engine trouble and also is the basic determinant for the rating of an engine. Part of the heat which is rejected is carried away in the exhaust gasses, the remaining passes through the metallic walls of the engine, causing expansion and internal stress in the parts. Also discussed input-output relationships in the engine as well as calculations for heat loss and engine cooling phenomena. The methods developed give some insight into the thermodynamic efficiency of the internal combustion engine.

Perlewitz R. E., Lon Mooney & Wm. Kalweit (1967) [3] made basic consideration to make optimal use of the material in the cylinder to obtain maximum heat transfer. The trapezoidal fin approaches the ideal construction and is more effective than either the rectangular or triangular types. This fin can be cast with comparative ease and has good strength characteristics. Many thin cylinder fins are better than a few thick fins, many short fins are better than a few long fins, providing the same amount of material is used and in engine above all, provision should be made for foreign material if the engine is run in a dirty environment.

Gale Nigel F. (1990) [4] discussed some of the design options for diesel engine cylinder heads. Since there are no firm rules concerning cylinder head design, it is better to avoid making firm conclusions on the choices available to designers. However, it is clear that certain design features provide far more acceptable compromises. The usefulness of the impulse swirl meter on a flow bench can be extended to separating swirl into two types: helical and directed swirl. Analysis of these two types of swirls can reveal potential improvements in port efficiency.

Biermann Arnold E. & Herman H. Ellerbrock (1993) [5] performed an analysis to determine the proportion of fins made of aluminium, copper, magnesium, and steel necessary to dissipate maximum quantity of heat for different fin widths, fin weights, and airflow conditions. The analysis also concerns determination of the optimum fin proportions when specified limits are placed on the fin dimension.

Zhang Yong et al (1998) [6] discussed an importance of low heat rejection (LHR) technique to reduce the thermal loads and heat rejection in the field of internal combustion engines. In heavy mechanical and thermal loads, cylinder heads are the most complicated parts and the key point of the LHR technique application in engines. And presented the researching work of the LHR cylinder head and its structure also presented the structure of a LHR cylinder head for vehicle engines.

Menon Zakirhusen K et al (2005) [7] conducted parametric study on fin heat transfer for air cooled motorcycle engines in this the fin profile and fin array parameters could be optimized in a better way by numerical simulation methods.

CFD can be used to determine optimal values of the fin parameters before design process.

Yoshida Masao et al (2006) [8] conducted an experiment to optimize fin layout of aircooled engine cylinder in air stream. In order to permit the development of design data, an experimental cylinder was developed having variable fin pitch and number of fin capability. Using the experimental cylinder, the effects of the number of fins, fin pitch and air velocity on cylinder cooling were investigated.

Tripathi Pradeep Mani et al (2014) [9] presented a paper on thermal analysis of the cylinder head assembly of the four-stroke engine. They created a detailed FE model consisting of main parts of the cylinder head assembly and it includes a description of thermal and mechanical loads and contact interaction between its parts. The model considers a temperature dependency of a heat transfer coefficient on wall in cooling passages as fins. They carried out analysis using the FEM program. The finite element method is applied to find the temperature distribution field from the parts of the cylinder head of SI engine.

Deshpande A.C. et.al (2015) [10] investigated the effect on heat transfer rate by changing the cross-section, fin pitch, fin Material and fin thickness. The vehicles they considered have single cylinder air cooled engines with a set of rectangular fins mounted on the cylinder block. They measured temperature generated at steady state from the fin surface through experiments and used the value as key parameter, heat dissipated and calculated heat flux through fins using empirical formulations. They also validated by using the FEA approach.

Yellaji Bade et.al. (2017) [11] conducted thermal analysis on heat distribution in fins of compressor cylinder by varying profile using FEM. They altered geometrical shapes of fins for analysis and select most effective cooling fin. They have work on rectangular, triangular, concave & convex profile fin of aluminium nitride and aluminium alloy A204 preferred for analysis. The parameters for analysis heat transfer rate through fin, fin efficiency and effectiveness through free and forced convection heat transfer mode. The results obtained with concave fin with material aluminium alloy A204 is better since heat transfer rate of the fin is more. By using concave fins, the weight of the fin body reduces compared to existing rectangular engine cylinder fin.

N. Arul et.al. (2017) [12] conducted experimental and computational analysis of various types of fins. Using CFD software the fluid analysis is done with existing design. The dimensions of the cylinder length, cylinder thickness, cylinder inner and outer diameter are initialized by us to a certain value corresponding to the existing available design.

K. Sathishkumar et.al (2017) [13] computational analysis of heat transfer through fins with different types of notches in which the fins with various configurations were modelled

using CREO 2.0 and analyses are done by using CFD – Fluent in order to find out the heat transfer rate.

Sorathiya A. S. et.al. (2017) [14] presented the augmentation of heat transfer coefficient for varying fins configuration of cylinder block of SI engine

Kumar Rajat et.al. (2020) [15] studied enhancement of the thermal properties by shifting geometry, material, and design of fins. The thermal analysis of fins by modifying its certain parameters such as geometry and plate fins and pin fins has been completed and by observing the analysis results, they say using conical draft pin fins with material aluminium alloy 1060 is better since the temperature drop and the heat transfer rate in a conical draft pin fins much more, compared to plate fin.

Shareef, S. K. Mohammad et.al. (2021) [16] presented numerical investigation of thermal properties of engine cylinder by varying geometry properties material and profile of cylinder using ANSYS workbench.

Abbood M. H. et.al. (2021) [17] conducted investigation on the effects of fin geometry on motorcycle cylinder cooling by adding eight fins with different shapes around the cylinder. They use Fluent software (ANSYS 19.0) for investigation. In investigation they varied Reynolds numbers (4, 6, and 8 x 104) under constant heat flux (6, 12, 25 kW/m²). Four types of fins, square, circular, elliptical, and air foil, all with the same thickness (5 mm), pitch gap between each fin (3 mm), and surface area (0.0745 m²) were investigated. The metal used for the fin bodies was aluminium alloy, with a thermal conductivity of 237 W/m-K. The working fluid used was air. They concluded that the best case was seen in the cylinder with square fins, which obtained the highest value of heat transfer coefficient, and the rate of the heat transfer increases when the Reynolds number increases.

3. OBJECTIVES

The aim of this project is to design and analysis of cylinder fins, for heat deception by changing the geometry and materials.

1. Creation of conceptual CAD model for study.
2. To enhance the heat transfer rate by making following changes
 - i) Change the geometry of fins i.e. circular & wavy shape fins in which the thickness of fin was kept constant i.e. 2 mm
 - ii) Change the material of the fin and selecting various materials for further process i.e. Aluminium, Aluminium 6061 & Aluminium 2014
4. Evaluate fin surface temperature computationally.

Table 3.1 : Selection of material and their properties.

Sr. No.	Materials	Density (kg/m ³)	Thermal conductivity (W/m ⁰ K)	Specific heat (J/kg ⁰ K)
1	Aluminium	2689	240	9s51
2	Aluminium 6061	2700	180	896
3	Aluminium 2014	2710	190	880

4. DESIGN OF FINS

4.1 Specifications of Model

For design we have selected the 125cc engine was selected and its specifications are as follows,

Table 4.1 : Specifications of Model

Model name	Honda Shine
CC	125
Stroke (mm)	58
Bore (mm)	52
Number of fins	6
Fin pitch (mm)	10
Fin thickness	2.5
Fin material	Al Alloy
Position of fins w.r.t cylinder axis	Perpendicular

1. Thickness of cylinder = 0.045D + 1.6 mm

$$= 0.045 \times 52 + 1.6 \text{ mm}$$

$$= 3.64 \text{ mm}$$

$$= 4 \text{ mm}$$
2. Maximum length of fin = 22 mm
3. Minimum length of fin = 7 mm
4. Circular fin profiles have 2 mm thick fins were modelled.
5. The number of fins for each model are 6.
6. The distance between the two top surfaces of the fins is maintained at 10 mm.
7. The engine cylinder's length is 58 mm; the outer and inner bore diameters are 60 and 52 mm.

4.2 Steps of involved in CAD Modelling

4.2.1 Circular Fins

For CAD modelling SOLIDWROKS 2020 software was used. The SOLIDWORKS® CAD software is a mechanical design automation application that designers quickly sketch out

ideas, experiment with features and dimensions, and produce models and detailed drawings.

Step 1: Select Front Plane and created 2D sketch rectangle of 58 x 60 and converted to 3D with revolve command, as shown in Fig.4.1 & 4.2

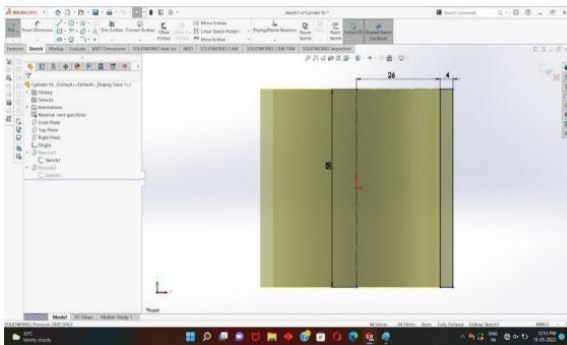

Fig. 4.1 : Created 2D Sketch of Cylinder

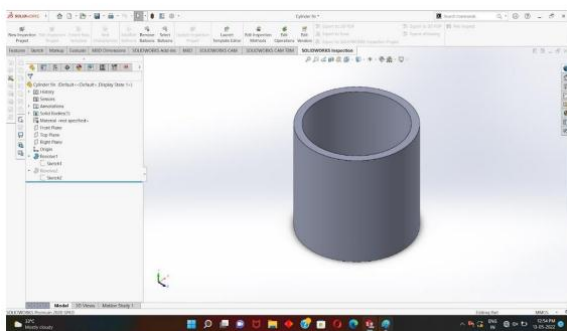

Fig. 4.2 : 3D with Revolve Command

Step 2: Sketch is made for extended surfaces i.e fins as shown in fig 4.3

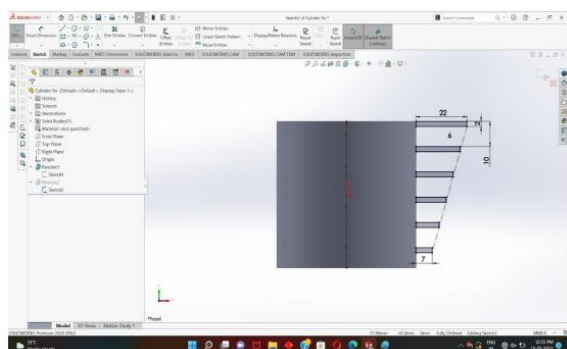

Fig. 4.3 : Sketch Is Made for Extended Surfaces

Step 3: Convert the sketch into 3D by Revolve command, as shown in Fig.4.4

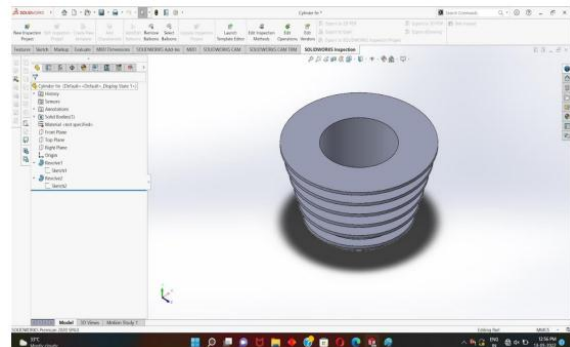

Fig. 4.4 : Convert the Sketch into 3D by Revolve Command

Step 4 : Final sketch of circular cylinder fin is as shown in fig.4.5

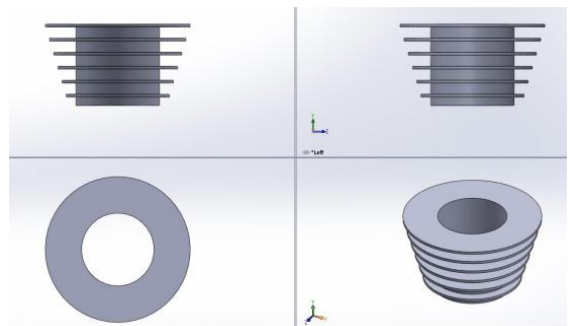

Fig. 4.5 : Final sketch of Circular Cylinder Fin

4.2.2 Wavy Fins

Convective heat flow can be enhanced by altering the shape of fin to wavy shape. The design of wavy fin involves the parameters like fin length, fin width, fin thickness, waviness angle, fin pitch and number of fins. Generally, fin length and number of fins are fixed by cylinder size, fin width will be decided by heat loss requirement as well as space available for the cylinder in motorbike while thickness must be kept less as far as possible for faster removal of heat, but manufacturing limitation and strength of cylinder fins put limitation as minimum as 2 mm or more. From the above discussion, it is clear that only two parameters i.e Fin waviness angle. & Fin pitch are needed to be designed and optimize for better heat transfer coefficient. Wavy fin has pitch four times more than its thickness and 20° of wave angle with 25 mm wavelength are recommended by Sorathiya A.S. [17]

Step 1: Select Front Plane and created 2D sketch line 102 mm & 20° of wave angle with 25 mm wavelength, as shown in Fig.4.6

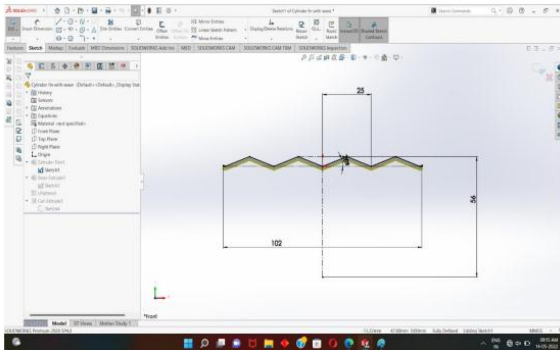

Fig. 4.6 : Select Front Plane and Created 2D sketch

Step 2: Then converted it into 3D by using Extrude command, as shown in Fig.4.7

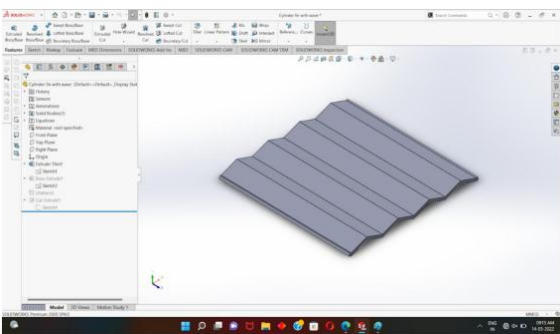

Fig. 4.7 : Converted it in to 3D by Using Extrude Command

Step 3: Draw a circle with radius of 30 mm at the center and remove the inner part by using cut and extrude command, as shown in Fig.4.8 & 4.9.

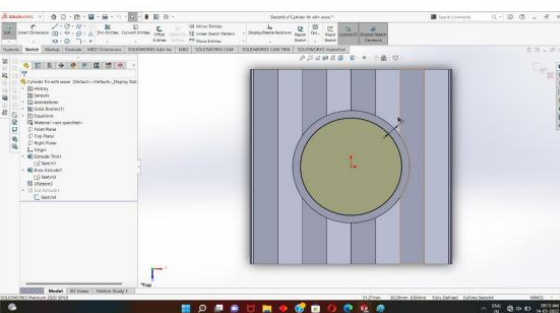

Fig. 4.8 :: Draw a circle

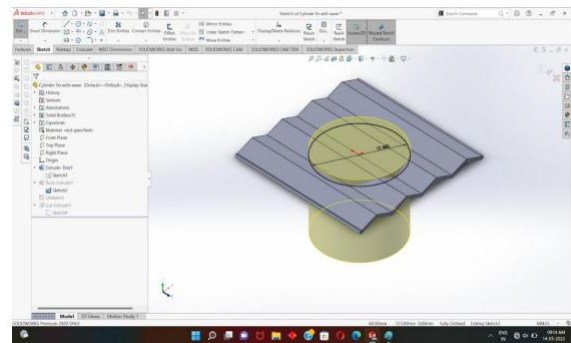

Fig. 4.9 : Remove the Inner Part by Using Cut and Extrude Command

Step 4: Draw a Wavy fins over cylinder using boss extrude, cut extrude & L Pattern Command, as shown in Fig.4.10.

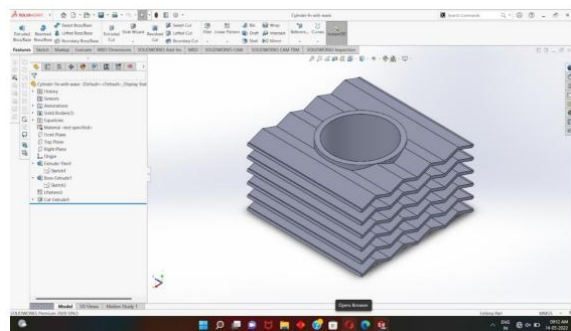

Fig. 4.10 : Draw a Wavy fins over cylinder

Thus, using above steps the circular & wavy shape fin models are created.

5. ANALYSIS OF FINS

The steady of thermal analysis determine the minimum temperature and heat flux as an object that does not vary with time. The surface temperature of engine cylinder is assumed to 200°C.

5.1 Assumption for analysis

1. The temperature of air does not change significantly.
2. Constant heat transfer coefficient is considered for air.
3. Most material properties are constant such as thermal conductivity, elasticity modulus, coefficient of thermal expansion etc.

5.2 Static thermal analysis

Step 1: Import the Geometry

The geometry of fin created with SOLIDWORKS has to be saved in ".igs" file format. So, that it can accessed through the ANSYS software. The analysis is carried out for steady state heat transfer process. The imported geometry of circular fin is shown in Fig.5.1 & of way fin is as shown in Fig.5.2

Step 2 : Generating the Mesh

1. Select the model and generate the mesh for the design.
2. For meshing, program-controlled mesh was used with adaptive sizing with medium smoothing.
3. 11454 nodes and 5480 elements were generated in circular fins, and in case of wavy fins 25792 nodes and 12257 elements are generated. The mesh model of circular fin with 11454 nodes & 5480 elements is shown in Fig.5.3 & of wavy fin with 25792 nodes & 12257 elements is shown in Fig.5.4

Step 3: Boundary conditions

A convection boundary condition is applied to the outside surface of the cylinder and the fins with the ambient temperature as 35°C and the convection coefficient as 28.75 W/ (m² °Q. The boundary conditions applied to outside surface of circular fin is shown in Fig.5.5 & of wavy fin is shown in Fig.5.6

Step 4: Loading conditions

For loading conditions selecting the inner surface of the cylinder, assign the value of the approximate value of wall temperature 2000 C is applied. The Loading condition applied on inner surface of circular fin is shown in Fig.5.7 & of wavy fin is shown in Fig.5.8

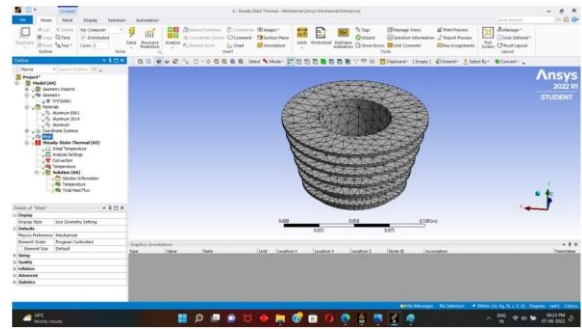

Fig. 5.3 : Mesh Model of Circular Fin

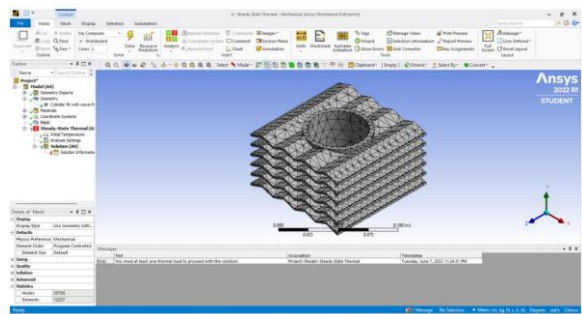

Fig- 5.4: Mesh Model of Wavy Fin

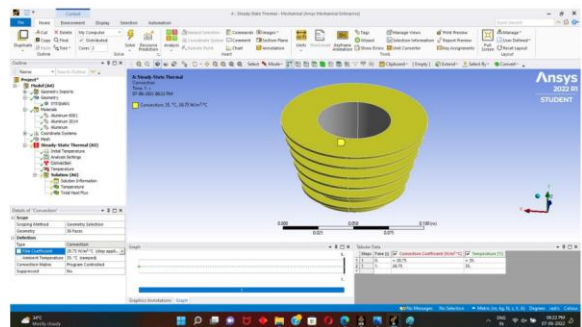

Fig. 5.5 : Boundary Conditions Applied to Circular Fin

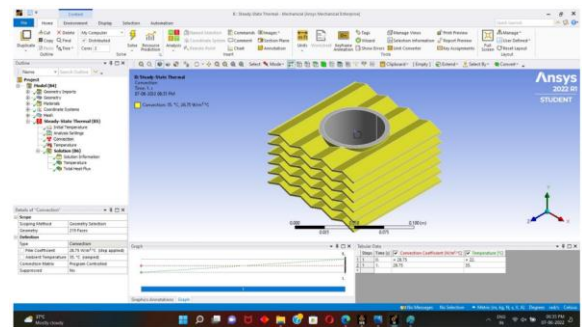

Fig. 5.6 : Boundary Conditions Applied Wavy Fin

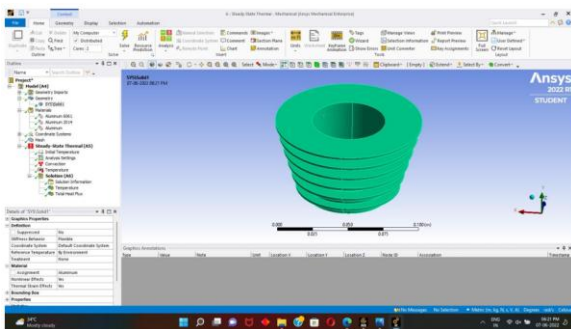

Fig. 5.1 : Geometry of Circular Fin

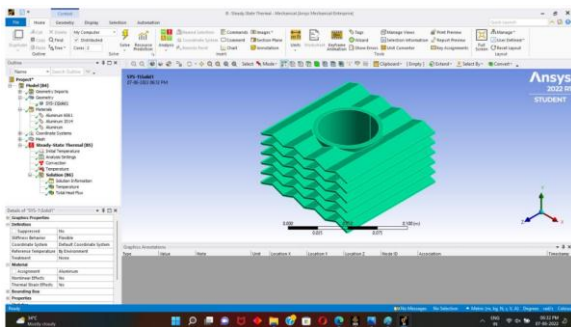

Fig. 5.2 : Geometry of Wavy Fin

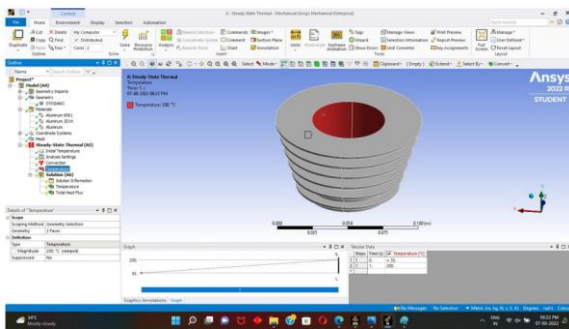

Fig.5.7 Loading Condition Applied to Circular Fin

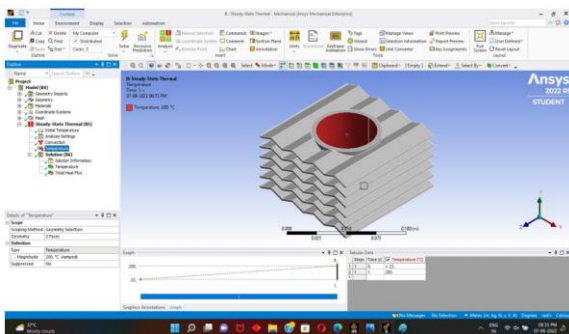

Fig. 5.8 : Loading Condition Applied to Wavy Fin

6. RESULTS & DISCUSSION

Following results are obtained from the thermal analysis of circular and wavy fins using ANSYS.

1. The steady state temperature of aluminium circular fin is found to be 164.42°C as shown in Fig 6.1 & the maximum and minimum heat flux is found to be $6.0933 \times 10^5 \text{ W/m}^2$ & 4950.8 W/m^2 respectively as shown in Fig 6.2.

2. The steady state temperature of aluminium 6061 circular fin is found to be 161.76°C as shown in Fig.6.3 & the maximum and minimum heat flux is found to be $6.5558 \times 10^5 \text{ W/m}^2$ & 5372.7 W/m^2 respectively as shown in Fig.6.4.

3. The steady state temperature of aluminium 2014 circular fin is found to be 162.64°C as shown in Fig.6.5 & the maximum and minimum heat flux is found to be $6.4033 \times 10^5 \text{ W/m}^2$ & 5232.5 W/m^2 respectively as shown in Fig.6.6

4. The steady state temperature of aluminium wavy fin is found to be 152.6°C as shown in Fig.6.7 & the maximum and minimum heat flux is found to be $5.2051 \times 10^5 \text{ W/m}^2$ & 10050 W/m^2 respectively as shown in Fig.6.8.

5. The steady state temperature of aluminium wavy fin is found to be 149.02°C as shown in Fig.6.9 & the maximum and minimum heat flux is found to be $5.614 \times 10^5 \text{ W/m}^2$ & 10869 W/m^2 respectively as shown in Fig.6.10.

6. The steady state temperature of aluminium wavy fin is found to be 150.02°C as shown in Fig 6.11 & the maximum

and minimum heat flux is found to be $5.4116 \times 10^5 \text{ W/m}^2$ & 10463 W/m^2 respectively as shown in Fig.6.12.

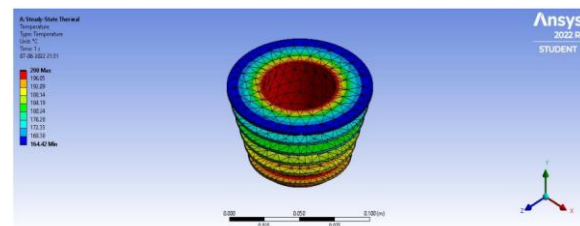

Fig. 6.1 : Steady State Temperature of Circular Fin (Aluminium)

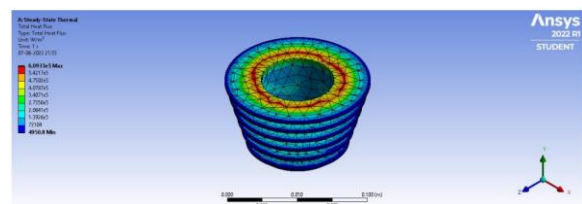

Fig. 6.2 : Steady State Total Heat Flux of Circular Fin (Aluminium)

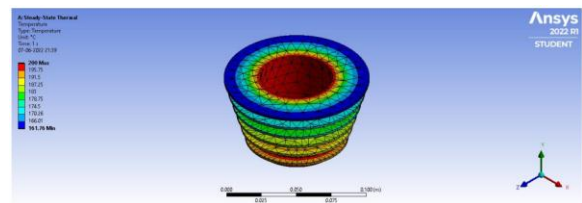

Fig. 6.3 : Steady State Temperature of Circular Fin (Aluminium 6061)

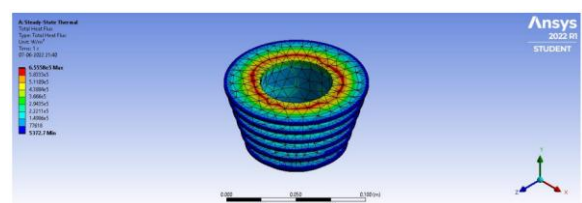

Fig. 6.4 : Steady State Total Heat Flux of Circular Fin (Aluminium 6061)

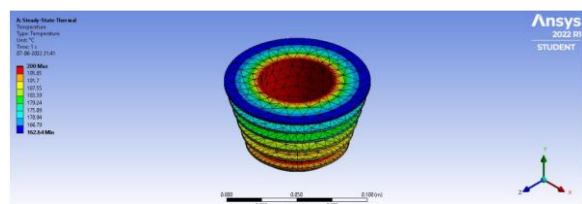

Fig. 6.5 : Steady State Temperature of Circular Fin (Aluminium 2014)

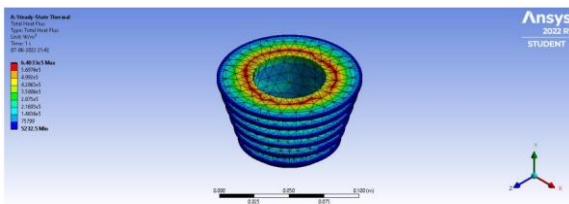

Fig. 6.6 : Steady State Total Heat Flux of Circular Fin (Aluminium 6061)

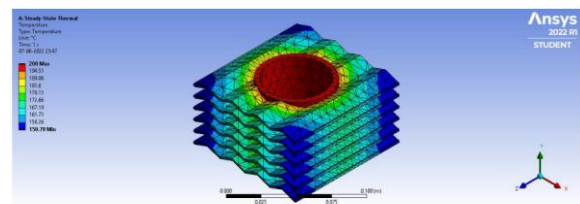

Fig. 6.11 : Steady State Temperature of Wavy Fin (Aluminium 2014)

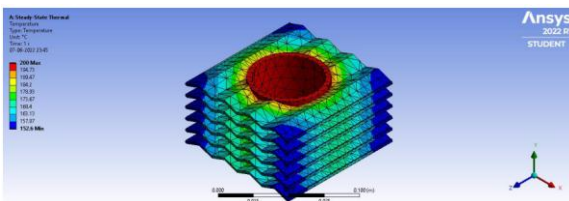

Fig. 6.7 : Steady State Temperature of Wavy Fin (Aluminium)

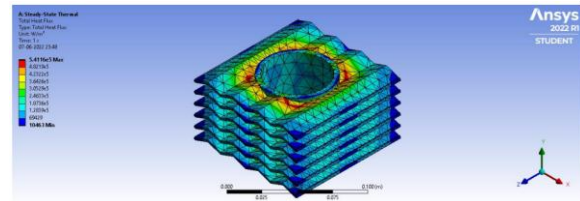

Fig. 6.12 : Steady State Total Heat Flux of Wavy Fin (Aluminium 2014)

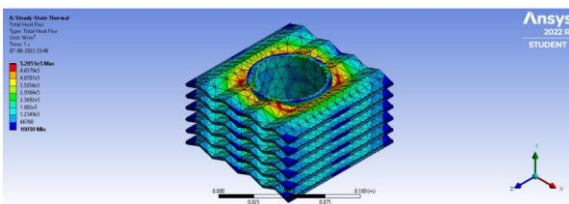

Fig. 6.8 : Steady State Total Heat Flux of Wavy Fin (Aluminium)

Table 6.1 : Temperature and Heat Flux values according to ANSYS

Material	Shape	Temperature (°C)		Heat Flux (W/m ²)	
		Max	Min	Max	Min
Aluminium	Circular fin	200	164.42	6.0933 X 10 ⁵	4950.8
Aluminium 6061	Circular fin	200	161.76	6.5558 X 10 ⁵	5372.7
Aluminium 2014	Circular fin	200	162.64	6.4033 X 10 ⁵	5232.5
Aluminium	Wavy fin	200	152.6	5.2051 X 10 ⁵	10050
Aluminium 6061	Wavy fin	200	149.02	5.614 X 10 ⁵	10869
Aluminium 2014	Wavy fin	200	150.79	5.4116 X 10 ⁵	10463

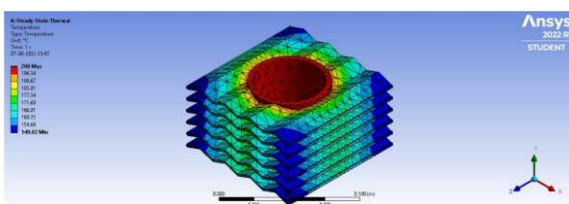

Fig. 6.9 : Steady State Temperature of Wavy Fin (Aluminium 6061)

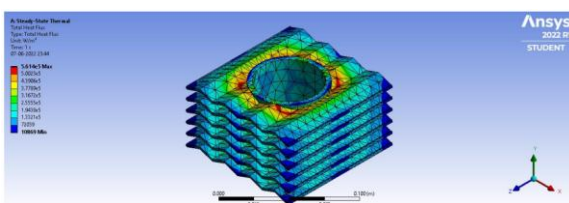

Fig. 6.10 : Steady State Total Heat Flux of Wavy Fin (Aluminium 6061)

Thus, from above tabulated results of thermal analysis of circular & wavy fins using ANSYS it is found that for aluminium 6061 wavy fins gives minimum temperature is 149.02°C, thus maximum heat transfer is feasible for wavy fins as compared to circular fins. From above discussion is cleared that as compared to circular fin, the wavy fin improves the cooling rate of the engine cylinder fin.

7. CONCLUSION

From the thermal analysis of cylinder fin, it is concluded that wavy fins with aluminium 6061 is more effective as compared to other fins, for which the fin temperature is found to be 149.02°C and its maximum & minimum heat flux is 5.614 x 10⁵ W/m² & 10869 W/m² respectively. Thus, wavy shape fins can replace the circular fins, so as to achieve effective heat transfer.

REFERENCES

- [1] Biermann, Arnold E. & Pinkel, Benjamin. (1934) "Heat transfer from finned metal cylinders in an air stream", University of North Texas Libraries, UNT Digital Library.
- [2] Cramer, Robert, (1967) "Heat Rejection and Cooling Requirements of Internal Combustion Engines". No. 670524. SAE Technical Paper.
- [3] Perlewitz, R. E., Lon Mooney, and Wm Kalweit, (1967) "Small Internal Combustion Engine Design-Cooling and Associated Parameters, Heat Rejection Methods". No. 670526. SAE Technical Paper.
- [4] Gale, Nigel F. (1990) "Diesel engine cylinder head design: the compromises and the techniques." SAE transactions: 415-438.
- [5] Biermann, Arnold E., and Herman H. Ellerbrock (1941) "The design of fins for air-cooled cylinders". No. NACA-TR-726. US Government Printing Office.
- [6] Zhang Yong, Zhang You, Chen Guohua and Zhang Baozhong (1998) "Structure Design and Finite Elements Analysis of LHR Cylinder Head for Vehicle Engines" No. 981487. SAE Technical Paper.
- [7] Memon, Zakirhusen K., T. Sundararajan, V. Lakshminarasimhan, Y. Babu, and Vinay Harne. (2005) "Parametric study on fin heat transfer for air cooled motorcycle engine." In International Mobility Engineering Congress & Exposition 2005-SAE India Technology for Emerging Markets, No. 2005-26- 361.
- [8] Yoshida, Masao, Soichi Ishihara, Yoshio Murakami, Kohei Nakashima, and Masago Yamamoto (2006) "Optimum Fin Layout of Air-Cooled Engine Cylinder in Air Stream." SAE Transactions: 1141-1149.
- [9] Tripathi, Pradeep Mani, Satya Prakash, Rahul Singh, and Satish Kumar Dwivedi (2014) "Thermal Analysis on Cylinder Head of SI Engine Using FEM." International Journal of Scientific Engineering and Research (IJSER), ISSN: 2347-3878.
- [10] Deshpande, A. C., and MohdRazik (2015). "International Journal of Engineering Sciences & Research Technology Design and Finite Element Analysis of TwoWheeler Engine Fins." ISSN: 2277-9655
- [11] Yellaji Bade (2017) "Thermal Analysis on Heat Distribution in Fins of Compressor Cylinder by Varying Profile Using Fem." ISSN:2348-4845. Design and Analysis of Cylinder Fins 2022 Mechanical Engineering Department BNCOE Pusad. Page 49
- [12] N.Arul, G.Srinivasan, K. Sriram, M.Vignesh, S.Vijayaraj (2017) "Experimental and Computational Analysis of Various Types of Fins" ISSN:2208-2727.
- [13] K. Sathishkumar, K. Vignesh, N. Ugesh, P. B. Sanjeevaprath, S. Balamurugan (2017) "Computational Analysis of Heat Transfer through Fins with Different Types of Notches" ISSN:2349-6495 pp, 2456-1908.
- [14] Sorathiya A.S., Rathod P.P (2017) "Augmentation of Heat Transfer Coefficient for Varying Fins Configuration of Cylinder Block of Si Engine" PHD thesis Department of Mechanical Engineering Rai University.
- [15] Kumar, Rajat, Devendra Singh, and Ajay Kumar Sharma (2020) "Static Thermal Analysis of Fins Models Using ANSYS." International Journal of Mechanical Engineering and Technology 11, No. 2.
- [16] Shareef, SK Mohammad, M. Sai Vikas, ALN Arun Kumar, Abhishek Dasore, Sanjay Chhalotre, Upendra Rajak, and Trikendra Nath Verma (2021) "Design and thermal analysis of engine cylinder fin body using various fin profiles." Materials Today: Proceedings 47, ISSN: 5776-5780.
- [17] Abbood, M. H., H. N. Azziz, and E. K. Farhoud (2021) "Investigating the effects of fin geometry on motorcycle cylinder cooling." In IOP Conference Series: Materials Science and Engineering, Vol. 1067, No. 1, pp. 012102. IOP Publishing.
- [18] R. K. Rajput, (2012), "Heat and Mass Transfer", Fifth Addition, pp 57 to 187.