

# High Performance Smart on Board Battery Charger

Mr. Shubham Sunil Patil<sup>1</sup>, Dr.S.K. Patil<sup>2</sup>

<sup>1</sup>Department of Electrical Engineering, Government College of Engineering, Karad, Maharashtra

<sup>2</sup>Associate Professor, Department of Electrical Engineering, Government College of Engineering, Karad, Maharashtra

\*\*\*

**Abstract**— Electric Vehicles (EVs) are a promising generation for accomplishing a sustainable transport area in the destiny, because of their very low to zero carbon emissions, low noise, excessive performance, and flexibility in grid operation and integration. This chapter consists of a top-level view of electric car technologies in addition to related energy storage systems and charging mechanisms. exceptional types of electric-force cars are presented. these consist of battery electric powered cars, plug- in hybrid electric automobiles, hybrid electric automobiles and gas cellular electric powered motors. The topologies for every category and the allowing technology are discussed. diverse strength educates configurations, new battery technology, and distinctive charger converter topologies are added.

Electrifying transportation not handiest allows a clean strength transition, but additionally allows the diversification of transportation's quarter gasoline blend and addresses strength safety worries. further, this can be also seen as a viable solution, with a purpose to alleviate issues associated with climate change. moreover, charging requirements and mechanisms and relative impacts to the grid from charging automobiles are also presented.

**Keywords** - Battery Charger, Bharat EV standard, Fast Charging, Electric Vehicle, Power Quality.

## 1. INTRODUCTION

Over the last decade there has been a developing interest, bordering on enthusiasm, for electric cars. Is the American motorist on the cusp of changing fuel-powered cars with electric powered variations? Will fuel stations be outmoded by way of rapid charging stations? Will the transportation region of the destiny be electrified? these questions are on the center of the electricity and transport debates. Governments have enacted subsidy programs, supported the setup of a charging infrastructure, and are beginning to broaden regulatory projects to assist and manage an electric car fleet. In reality, some governments—which includes the uk and France—have announced that they'll no longer permit the sale of latest fossil- fueled vehicles after 2040. the auto producers that were first of all skeptical about electric motors are actually committing billions of dollars to their manufacturing. with the aid of 2030 there may be fully battery- electric automobile fashions available for buy in India. The advancement of EV era has multiplied the social and monetary blessings in both the transportation and strength sector. no matter these advantages, battery technology limitations including weight, lifespan, and storage potential, and excessive battery cost are still the fundamental obstacles to the huge reputation of EVs. but, many car industries, groups, and international locations are making an investment within the studies and improvement of EV battery technology. for example, Google spent \$10 million, and the U.S. government spent \$2 billion on the development of an EV battery. furthermore, the U.S. authorities have committed to bringing 1,000,000 Plug-in EVs onto the street inside the next 5 years. thinking about the research and development in EV industries, according to the Australian electricity marketplace commission (AEMC) worldwide fashion of increasing EV and lowering ICE income is also gift. In Australia, the EV sale in 2019 turned into 6718, a 203% boom compared to 2018.

Likewise, in current years, the brand new Zealand government has set the goal for the transition to a hundred% renewable electricity by using 2035. In New Zealand eighty-five% of strength generation is based totally on renewable: 60% hydro, 18% geothermal, 5% wind, 2% biomass, and 15% is a fossil fuel, New Zealand's sturdy factor is the huge mix of renewables which include hydro, geothermal, wind, and biomass for energy era. As 30% of the fossil fuel is consumed with the aid of the transportation region, this gives a very good possibility to transition from fossil fuels to renewable strength via using generation, including the electric car. This overview paper investigates gift EV technology in reference to numerous present charging methods and requirements. the key contributions of the paper are the thorough overview and discussion of EV and related technologies, which include: This review paper investigates present EV technologies in connection with several existing charging methods and standards.

The key contributions of the paper are the thorough review and discussion of EV and related technologies, including:

- (i) Charging standards as defined with the aid of the Society of the car Engineers (SAE);

- (ii) EV charging structures along with on-board and off-board chargers, and
- (iii) Optimization techniques for sizing and placement of EV charging stations underneath extraordinary objectives and constraints.

## 2. COMPONENTS OF THE BATTERY CHARGER

1. Grid
2. Filter & Ac Measurement
3. Front End Converter
4. DC-DC Converter with Galvanic Isolation
5. EV Battery

### 1. Grid:

An electrical grid is an interconnected community for strength transport from manufacturers to purchasers. electrical grids vary in size and might cover whole nations or continents.

Grids are nearly constantly synchronous, which means all distribution regions perform with three segment alternating cutting-edge (AC) frequencies synchronized (so that voltage swings arise at almost the identical time). This permits transmission of AC energy throughout the location, connecting a large range of energy turbines and customers and probably permitting extra efficient electricity markets and redundant technology.

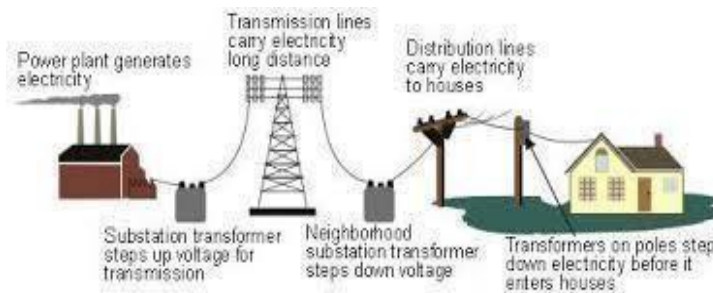

### 2. Filter & Ac Measurement

It consists of 3 phase RL clear out & modern-day Sensor, price Transaction, three segment voltage Sensor and PLL (segment locked loop) machine. RL circuit works efficiently as a low bypass filter. It blocks high-frequency alerts from entering and permits low-frequency indicators to pass through unimpeded. cutting-edge sensors, additionally commonly known as modern transformers or CTs, are devices that degree the cutting-edge running thru a wire via the use of the magnetic discipline to hit upon the modern and generate a proportional output. they're used with each AC and DC current. Voltage sensors are wi-fi gear that can be attached to any variety of assets, equipment or gadget. They offer 24/7 tracking, continuously watching for voltage statistics that may want to indicate a trouble. Voltage sensors stumble on magnetic fields, electromagnetic fields, and measure contact voltage. PLL is used to enforce synchronization among the manipulate loop and the grid gadget, but, a big amount of penetration of distributed technology structures within the grid will unavoidably deliver rise to the grid machine balance problem.

### 3. Front End Converter

It consists of DC Bus present day Sensor, Capacitors, DC Bus Voltage Sensor, Sensor Dynamics, rate Transition & FEC. And FEC Block is composed common, stage & level three Blocks. current sensors, additionally usually referred to as contemporary transformers or CTs, are devices that measure the modern-day running through a cord with the aid of the use of the magnetic area to detect the cutting-edge and generate a proportional output. they are used with both AC and DC modern-day. A capacitor is an electrical Component that attracts power from a battery and shops the electricity. inside, the

terminals hook up with two metallic plates separated by way of a non-engaging in substance. whilst activated, a capacitor speedy releases electricity in a tiny fraction of A voltage sensor is a sensor used to calculate and monitor the amount of voltage in an item. Voltage sensors can decide the AC voltage or DC voltage level. The center of this sensor is the voltage, whereas the output is the switches, analog voltage sign, a modern-day signal, or an audible signal. The fee Transition block transfers data from the output of a block operating at one price to the center of a block running at a distinctive rate. Use the block parameters to trade records integrity and deterministic switch for quicker response or decrease memory necessities. A front-charge power digital converter is a time period used whilst a converter is connected to an ac mains or source either using a transformer or without out the use of a transformer. An again-charge power digital converter is one that is connected to the weight. Such converter term is used frequently in a degree power converter machine.

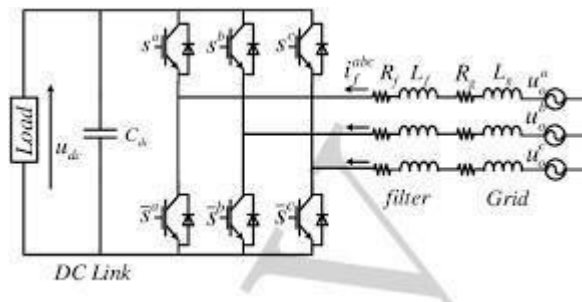

#### 4. DC-DC Converter with Galvanic Isolation

A vital role in the performance of a galvanically remoted DC-DC converter is played by way of the isolation transformer, whose traits affect machine power performance and most isolation score, in addition to the combination degree and standard expenses. Galvanic isolation (generally simplified to just isolation) is the physical and electrical separation between one segment of a circuit and some other. A end result of isolation is that each of the isolated circuits has its own return or ground reference. Even though DC/DC converters are to be had without enter-output isolation, many use an internal transformer to electrically (galvanically) separate the output from the enter.

DC/DC converters, the most typically used lessons are: practical-the output is remoted, however there may be no safety against electric shock.

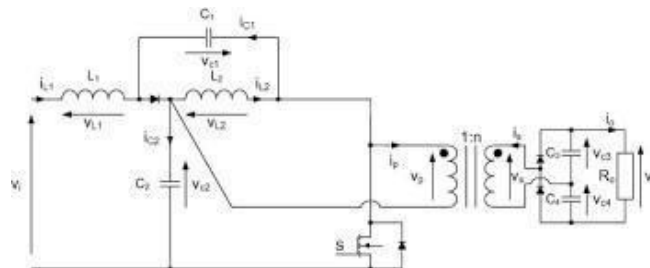

#### 5. EV Battery

A Lithium-ion (Li-ion) battery is a form of rechargeable battery used in electric automobiles and some of transportable electronics. they have got a higher strength density than ordinary lead-acid or nickel-cadmium rechargeable batteries. which means battery manufacturers can save space, decreasing the overall length of the battery %. Lithium is also the lightest of all metals. however, lithium-ion (Li-ion) batteries comprise no lithium steel, they contain ions. For those questioning what an ion is, an ion is an atom or molecule with an electric powered fee as a result of the loss or gain of 1 or extra electrons.

3.1 Battery Charging Current (A)

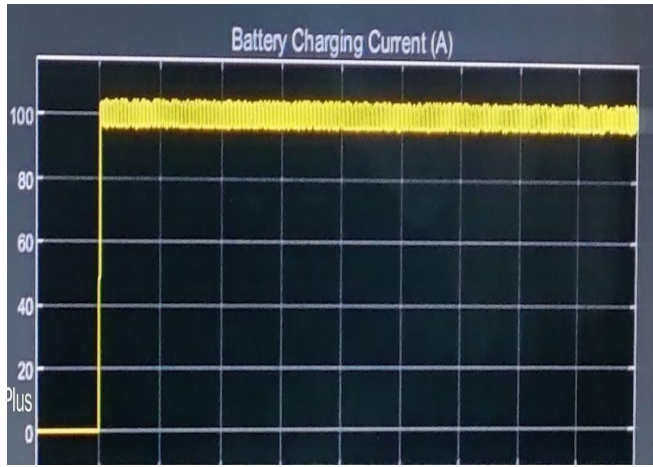

FEC DC OUTPUT CURRENT

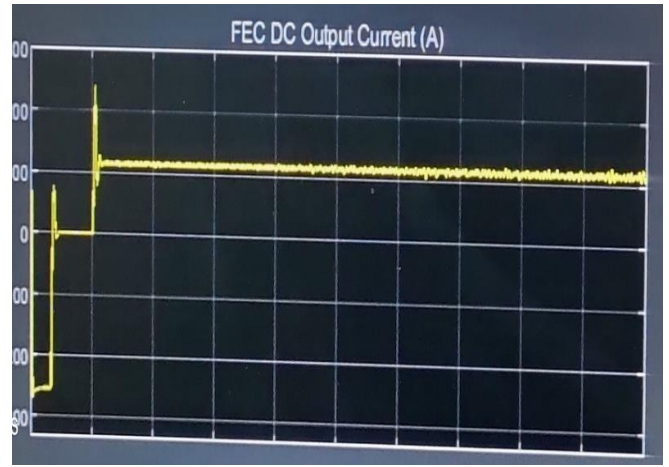

GRID APHASE VOLTAGE(V) AND CURRENT (A)

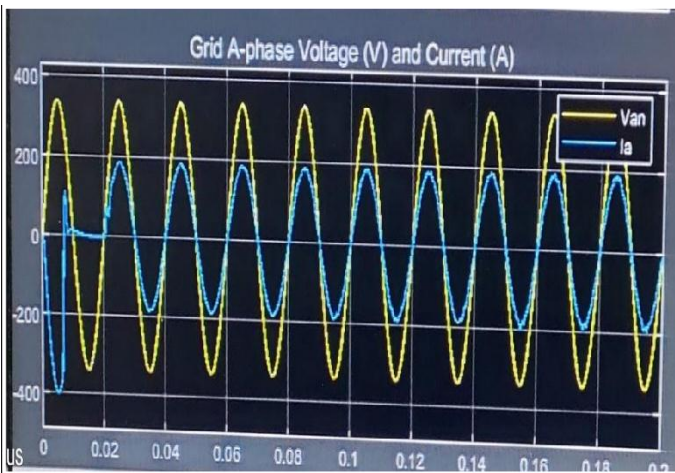

BATTERY SOC

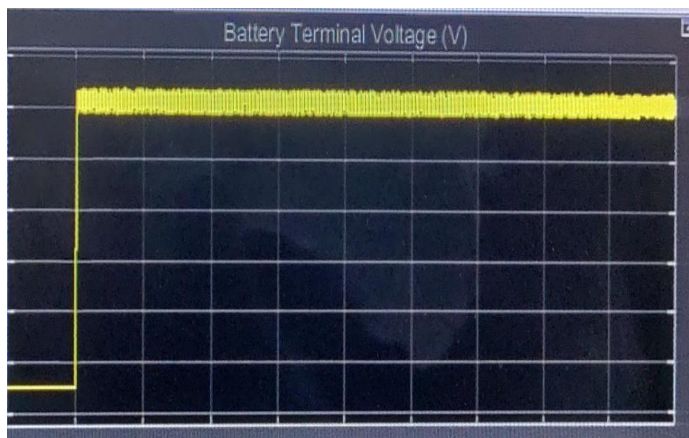
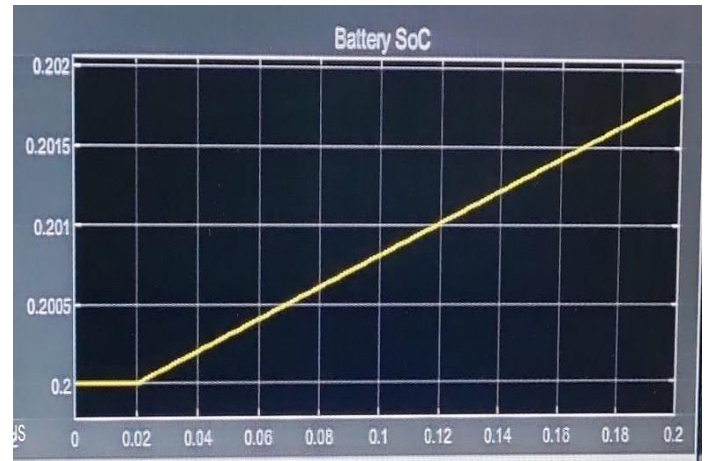

BATTERY TERMINAL VOLGATE (V)

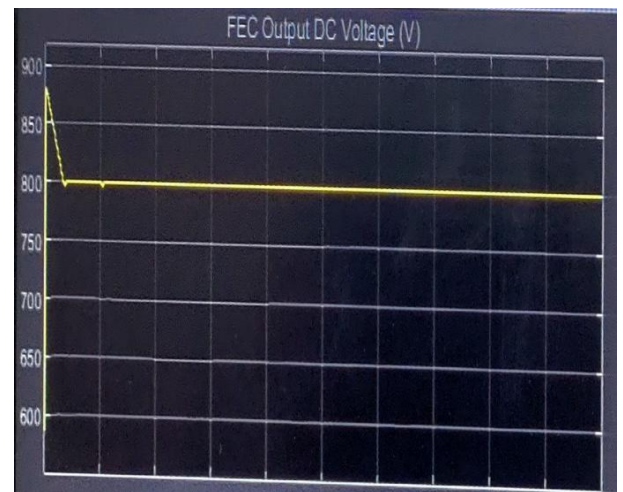

#### 4. Conclusion

Benefits in terms of computational demand or ability to seize phenomena not reflected by using well known P2D fashions. Many studies on fast charging protocols have been of empirical or experimental nature, and consequently their overall performance has handiest been assessed for a restrained range of mobile chemistries, shape factors, and working conditions. Such outcomes can't be effortlessly extended to other mobile types or ambient temperatures, as supported by the often-conflicting findings said by way of extraordinary authors. alternatively, most of the model-based totally charging optimization research are based totally on SP or ECM kind models that might not be accurate at high currents, while their outcomes are frequently demonstrated simplest towards different models or now not at all. accurate and demonstrated cellular and percent fashions and progressed expertise of proscribing phenomena is had to permit the design of charging protocols without the need for big laboratory checking out. Few charging optimizations studies up to now have addressed the special case of low temperature fast charging, in an effort to be increasingly more critical as deployment of EVs hurries up in chillier climates. To similarly optimize the charging procedure for person cells in a percent and avoid nearby degradation or overcharge, Increasing the range of public charging stations is a should. home and workplace charging are dominant charging forms. however, additionally the public charging infrastructure should maintain tempo with the modern-day mass advent of electric motors. electric cars are expected to enter the world market such that by using 2030, 10% of the automobiles can be of EV kind. To have a higher expertise on EV era, this looks at outlines the numerous styles of EV, battery chargers and charging stations. A comprehensive assessment has additionally been made at the standards presently followed for charging EV international. For better know-how on the country of the artwork EV generation, a assessment is made on the industrial and prototype electric automobiles in terms of electric variety, battery size, charger strength and charging time. Electrification of delivery is undisputable one of the key strategies to address climate change. The want to lessen range anxiety and meet client expectancies has pushed many producers to goal speedy charging functionality as a crucial design function for EV battery packs. whilst significant efforts have been committed to diverse elements of speedy charging in the recent years, many understanding gaps still exist. thus far, no dependable onboard methods exist to discover the prevalence of essential degradation superior BMSs with cellular balancing abilities will be required. whilst lots attention has been afforded to the layout of thermal management structures already, in addition, studies is still had to check the performance and homogeneity carried out via diverse preheating and cooling technologies. for example, few studies have tried to evaluate the results of AC pre-heating with subsequent fast charging on mobile lifetime, or to quantify the temperature gradients precipitated by this method.

Optimization of tab layout and site and of the geometrical layout of cooling structures can be any other large route to improving temperature and current homogeneity. outside cooling technologies incorporated with EV chargers might be useful in decreasing the load and cost of on-board cooling structures, but whether or not such solutions should reap the required cooling prices or temperature uniformity remains to be studied. ultimately, the links among cell level and p.c. stage degradation costs are nonetheless not well understood. multiple charging and pre heating strategies had been tested for unmarried cells, however the results, feasibility, and price of their implementation in battery packs have no longer been studied. it is practicable that a few charging protocols that bring about advanced performance for single cells may additionally cause current or temperature heterogeneities when done on a p.c. study in this subject matter might be required earlier than any non-traditional protocols are phenomena tether wth lithium plating or mechanical racking. implemented in real-global structure. moreover, few modelling works strategies for detecting lithium plating based on the function voltage plateaus are promising for on-line utility, but completely have addressed the impacts of cell-to-cellular version on % degree performance on account that fast charging can predicted to extend heterogeneities ,such multiscale research are urgently wished. dependable techniques to distinguish lithium stripping from other plateau-inducing phenomena, or to locate plating wherein no plateau is observed, have not but been mentioned. Many alternative electrode materials had been proposed that could doubtlessly improve rapid charging capabilities of Li-ion cells, however lots stays to be studied concerning their stability, possible degradation mechanisms, ease of manufacture, and price. Regardless of the reality that graphite anodes are especially prone to lithium plating, they may probably hold to dominate the Li-ion battery marketplace inside the foreseeable future due to their low value, wide availability, and technology maturity. current modelling processes have big limitations: ECM-based models, with the exclusion of a few physics- informed ones, do no longer capture information approximately the internal states of the battery and are handiest reliable in a constrained variety of situations which can't usually be extended to abuse conditions. however, the excessive fidelity of full order electrochemical models renders them beside the point for actual-time implementation. there is therefore a clear want for accurate decreased order models able to reproducing key internal states that might be applied in future fast charging enabled BMSs.

Physics-based ECMs could also provide improvements in multi scale modelling will be important to integrating cell and % level design and control, gambling an essential role in linking studies on one-of-a-kind scales to improvements inside the overall performance of commercial systems.

## 5. References

- 1) Electric Vehicles Charging Technology Review and Optimal Size Estimation Morris Brenna<sup>1</sup> · Federica Foidelli<sup>1</sup> · Carola Leone<sup>1</sup> · Michela Longo<sup>2</sup> October
- 2) An Integrated High Power Self-Equalized Battery Charger Using a Voltage Multiplier and Phase-Shifted Full-Bridge DC-DC Converter for Lithium-Ion Batteries Mohsen Feizi<sup>1</sup>, Reza Beiranvand<sup>2</sup>, †, Mahdi Daneshfar<sup>3</sup>, 2020-09-12 .
- 3) Renewable Energy Tracking and Optimization in a Hybrid Electric Vehicle Charging Station , Andrija Petrusic and Aleksandar Janjic , 29 December 2020 .
- 4) Planning of Fast EV Charging Stations on a Round Freeway Xiaohong Dong, Yunfei Mu *Member, IEEE*, Hongjie Jia, *Member, IEEE*, Jianzhong Wu, *Member, IEEE*, Xiaodan Yu DOI 10.1109/TSTE.2016.2547891
- 5) Impact of Electric Vehicle Charging Station Load Distribution Network Sanchari Deb , Kari Tammi , Karuna Kalita and Pinakeshwar Mahanta 15 January 2018
- 6) The state of the art of battery charging infrastructure for electrical vehicles: Topologies, power control strategies, and future tren Viet Thang Tran.
- 7) Zhongdong Yin, Pei Wang “Methods to Suppress Voltage Ripple of Fast Charging of Electric Vehicle Based on Active Disturbance Rejection Control Technique” 2017 IEEE 3rd International Conference on Control Science and Systems Engineering:
- 8) Khushboo Arora, Sapna Katiyar, Rachit Patel “Design and Analysis of AC to DC Converters for Input Power Factor Correction”, 978-1-5090-2399-8/16/\$31.00 c 2016 IEEE
- 9) Piyush Sharma, Dheeraj K Dhaked, Sachin Saini, Love K Tripathi, Ashish Shrivastva, “Analysis of Different Converters for Reduced Total Harmonic Distortion and Improved Power Factor” 2018 5th International Conference on Signal Processing and Integrated Networks (SPIN)
- 10) Pahlevaninezhad, M.; Das, P.; Drobnik, J.; Jain, P.K.; Bakhshai, A. “A New Control Approach Based on the differential Flatness Theory for an AC/DC Converter Used in Electric Vehicles,” *Power Electronics, IEEE Transactions on*, vol.27, no.4, pp.2085,2103, April 2012.
- 11) M. Yilmaz and P. T. Krein, “Review of the impact of vehicle-to-grid technologies on distribution systems and utility interfaces,” *IEEE Trans. Power Electron.*, vol. 28, no. 12, pp. 5573–5689, Dec. 2013.
- 12) I. Y. Chung, W. Liu, D. A. Cartes, E. Collins, and S. I. Moon, “Control methods of inverter- interfaced distributed generators in a microgrid system,” *IEEE Trans. Ind. Appl.*, vol. 46, no. 3, pp. 1078 – 1088, May/June 2010
- 13) M. Yilmaz and P. T. Krein, “Review of the Impact of Vehicle-to-Grid Technologies on Distribution Systems and Utility Interfaces,” *IEEE Transactions on Power Electronics*, vol. 28, no. 12, pp. 5673-5689, Dec. 2013.
- 14) K. Clement, K. Van Reusel, and J. Driesen, “The consumption of electrical energy of plug-in hybrid electric vehicles in Belgium,” in *Proc. 2nd Eur. Ele-Drive Transportation Conf.*, Brussels, Belgium, May 2007
- 15) A. Bonhomme, D. Cortinas, F. Boulanger, and J. L. Fraise, “A new voltage control system to facilitate the connection of dispersed generation to distribution networks,” in *Proc. Inst. Elect. Eng.*, 2001, p. 4.8..
- 16) Abdul Ghaffar<sup>1</sup>, Engr. Jahangir Badar Soomro<sup>1</sup>, Altaf Hussain, Dr. Faheem A. Chachar<sup>1</sup> “Power Quality Analysis of Controlled Rectifiers and their Impact on Input Power System”
- 17) Rohit Gupta, Ruchika Department of Electrical and Instrumentation Engg, Thapar University “A Study of TAC/DC Converter with Improved Power Factor and Low Harmonic Distortion” *International Journal on Computer Science and Engineering (IJCSE)*
- 18) Review of Electric Vehicle Technologies, Charging Methods, Standards and Optimization Techniques Syed Muhammad Arif<sup>1,2</sup>, Tek Tjing Lie<sup>1,\*</sup>, Boon Chong Seet<sup>1</sup>, Soumia Ayyadi<sup>3</sup> and Kristian Jensen<sup>2</sup>
- 19) Portable Battery Charger for Electric Vehicles , JAN 2021 DOI: [10.1109/SeFet48154.2021.9375782](https://doi.org/10.1109/SeFet48154.2021.9375782), Aman Kumar Jha, Bhim Singh.