

# SIMULATION STUDY ON THE CHARACTERISTICS OF LOOSE SOIL OF ARROW SHOVEL

Wei Huijun<sup>1</sup> , Cen Haitang<sup>1</sup> , Li Ling<sup>1</sup> , Qin Jianguo<sup>1</sup> , Na Risu<sup>1</sup> , Wan Qihao<sup>2</sup>

(1. School of Mechanical Engineering, Inner Mongolia University of Technology, Inner Mongolia Autonomous Region, 010051, China;

2. Hohhot Branch, Institute of Grassland Research of CAAS, Inner Mongolia Autonomous Region, 010010, China)

-----  
\*\*\*  
-----

## Abstract

China has a vast natural grassland, which is the cornerstone and guarantee of livestock development. However, in recent years, grassland degradation has become increasingly serious and the growth of forage grasses has been inhibited. Therefore, many improvement measures for degraded grasslands have been developed in China. One of the important tools for degraded grassland improvement is the arrow shovel submerged pine plow. As a key working component, the operational performance of the arrow shovel is closely related to the grassland soil characteristics. In this paper, the discrete element method is used to establish a four-layer soil discrete element model by reasonably selecting the grassland soil parameters and setting the soil particle types to visually demonstrate the loosening process of the arrow shovel. The simulation shows that the surface layer of the arrow shovel is less disturbed during soil loosening, and the shallow loosening effect is good, which can effectively prevent the destruction of surface vegetation and is especially suitable for the improvement and restoration of dry grassland with shallow soil layer; the fluctuation of force on the arrow shovel is large, and the optimization of structural parameters is the key to improve the drag reduction effect of the arrow shovel.

**Key words:** arrow shovel, soil disturbance, discrete element method, grassland improvement

## 1 Introduction

China has a vast land area with nearly 400 million hectares of natural grasslands, occupying 40% of the national land area, which is the largest terrestrial ecosystem in terms of area. At the same time, natural grasslands also provide adequate conditions for the development of animal husbandry in China and are a major guarantee for the development of animal husbandry [1]. However, in recent years, due to natural and human factors and other reasons, grasslands have been degraded to different degrees throughout the country [2-4]. Grassland degradation directly leads to a significant decrease in forage production per unit area within the grassland and a decrease in forage quality, which affects the normal growth and development

needs of grasslands and seriously restricts the development of livestock industry [5].

Increasing the construction of degraded grassland improvement is conducive to protecting biodiversity and improving grassland productivity, which has significant ecological significance and economic benefits [6-7]. The arrow shovel submerged loosening plow produced by Versatile, Canada, cuts the forage or plant roots at the depth of plowing after entering the soil, breaks the slab layer of soil and grass roots, increases the permeability of the soil, and is conducive to the rejuvenation of the original grassland vegetation [8]. To improve the adaptability of the arrow shovel submerged pine plow for different areas of grassland degradation and soil characteristics is an important step in promoting the application of this advanced

machine. As a key working part, the operational performance of arrow shovel is closely related to soil characteristics, and it is an important reference value to carry out the simulation analysis of arrow shovel operation process and study the soil disturbance characteristics of arrow shovel to optimize the geometric parameters of arrow shovel and improve the operational performance of arrow shovel submerged pine plow.

## 2 Establishment of discrete element simulation model

### 2.1 Establishment of the arrow shovel 3D model

The structure of arrow shovel is composed of shovel blade, shovel base, plow column and connecting plate, etc. The shovel blade and shovel base are connected by a removable connection, which is convenient for sharpening and replacement. In order to ensure that the simulation analysis is the same as the real situation, the 3D drawing software is used to draw the 3D model of the arrow shovel according to the scale of 1:1. The structure of the arrow shovel is shown in Fig.1, the structure of the arrow shovel blade is shown in Fig.2, and the main parameters of the shovel blade are shown in Table 1.

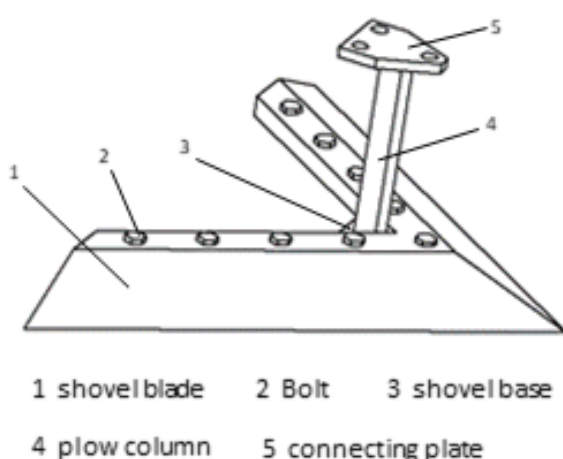

Fig.1 Arrow shaped shovel 3D model

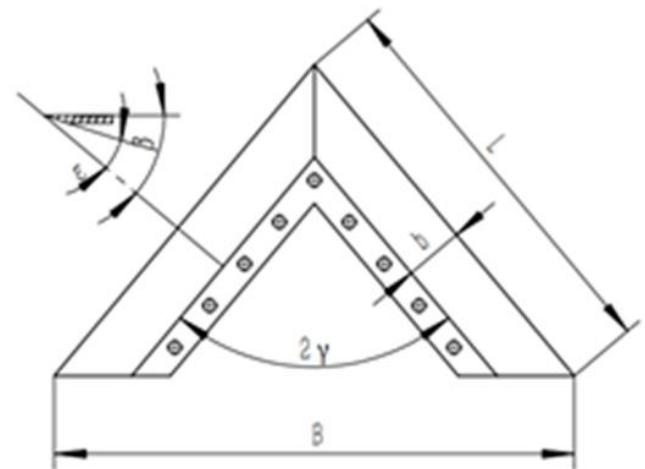

Fig.2 Schematic diagram of shovel blade structure and parameters

Table 1 Main parameters of arrow shovel blades

Parameter Name	Numerical size
open horns of Shovel wings $\gamma/^\circ$	40
Loose soil corner $\beta/^\circ$	30
Gap Corner $\epsilon/^\circ$	11.61
Length of shovel blade L/mm	522.16
Width of shovel blade b/mm	76.6
Working width B/mm	617.28

### 2.2 Soil discrete element modeling

The grass soil model was created in the discrete element software and its basic dimensions were set to 1000 mm \* 1000 mm \* 400 mm. where the parameters used in the grass soil discrete element model included material parameters and contact parameters.

The material parameters include Poisson's ratio, density and shear modulus of the soil, and 65Mn [9]. The shear modulus can be obtained by calculating it as

$$G = \frac{E}{2(1 + \nu)}$$

However, due to the participation of various plant roots in the surface turf of grassland soil, the plant roots will anchor and plate the soil layer with each other, resulting in larger particle size and increased shear modulus of the soil layer. Therefore, the surface turf shear strength reference experiment [10] was conducted to simulate the shear strength of grassland surface turf with the

shear modulus of the sheepgrass root-soil complex.

The contact parameters mainly include the recovery coefficient between soil-soil and soil-65Mn, static friction coefficient and dynamic friction coefficient, which can be obtained through specific experiments [11] to ensure that the established soil model is the same as the real situation. The specific parameters of the soil model are shown in Table 2.

To facilitate the analysis of the movement state and disturbance behavior of the soil at different depths during the arrow shovel operation, the height of each soil layer was set to 100 mm. therefore, the soil in the soil tank was set to four soil layers, and the soil layers were defined as four layers from top to bottom: surface, shallow, medium, and deep. According to a large

number of studies, the basic structure of soil particles includes nuclei, columns, and blocks, and the four particle models are shown in Fig.3 [12]. Each soil layer is filled with four types of soil particles in turn. The types and numbers of soil particles are shown in Table 3.

The 3D model of the arrow shovel was imported into the discrete element software. The plowing depth was set to 200 mm, the material of the arrow shovel was 65 Mn, and the speed of the arrow shovel was 0.83 m/s, which was in line with the actual situation.

The simulation setting time is 6s, and the discrete element model of deep soil is obtained after each soil grain is cast, as shown in Fig.4.

**Table 2** Soil model specific parameters

Parameter Name	Numerical
Loose shovel speed $v/(m/s)$	830
Loose soil depth $h/mm$	350
density of Soil particle $\rho_2/ (kg/m^3)$	1346
Poisson's ratio of soil particles $\nu_1$	0.4
Shear modulus of soil particles $G_1/Pa$	$1 \times 10^6$
Shear modulus of surface soil particles $G_2/Pa$	$4.1 \times 10^6$
Density of 65 Mn Steel $\rho_2/ (kg/m^3)$	7830
Poisson's ratio of 65 Mn Steel $\nu_2$	0.35
Shear modulus of 65 Mn Steel $G_3/Pa$	$7.27 \times 10^{10}$
Coefficient of restitution between the soil and soil $e_1$	0.2
Coefficient of rolling friction between the soil and soil $e_2$	0.3
Coefficient of static friction between the soil and soil $e_3$	0.4
Coefficient of restitution between the soil and 65 Mn Steel $f_1$	0.3
Coefficient of rolling friction between the soil and 65 Mn Steel $f_2$	0.4
Coefficient of static friction between the soil and 65 Mn Steel $f_3$	0.5
Gravity acceleration $G/(m/s^2)$	9.81



(a) Lumpy particles1

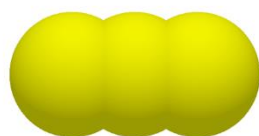

(b) Nucleated particles

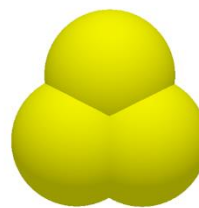

(c) Lumpy particles2

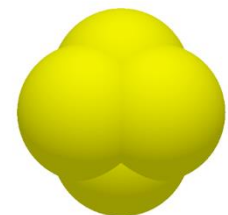

(d) Columnar particles

**Fig.3** Four soil particles

**Table 3** Types and quantities of different soil particles

Soil layer	Particle type	Number of particles
Surface layer	Lumpy particles1	15000
Shallow layer	Nucleated particles	26000
Middle layer	Lumpy particles2	26000
Deep layer	Columnar particles	24000

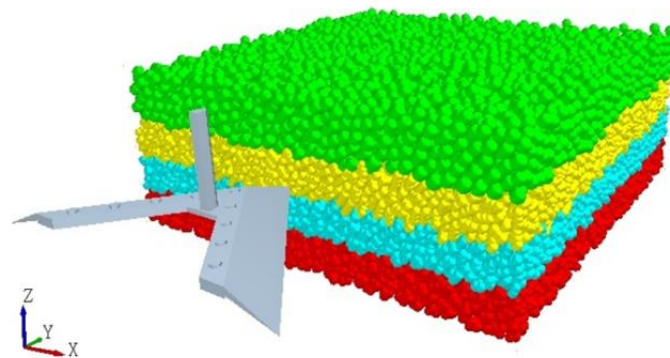

**Fig.4** Discrete metamodel of degraded grassland soils

### 3 Simulation of dynamic characteristics of loosened soil

#### 3.1 Loose soil disturbance state analysis

In order to understand in detail the disturbance state of the soil during the operation of the arrow shovel, the discrete element software was used to simulate the operation process of the arrow shovel, and the longitudinal section of the soil was intercepted to further understand the working mechanism of the arrow shovel on the grass. As shown in Figure 5.

The simulation analysis shows that 0 s arrow shovel starts to enter the soil, 0.5 s arrow shovel completely enters the soil, 0.8 s arrow shovel completely moves in the soil, 1.2 s arrow shovel prepares to leave the soil model, and 1.6 s arrow shovel completely leaves the soil model.

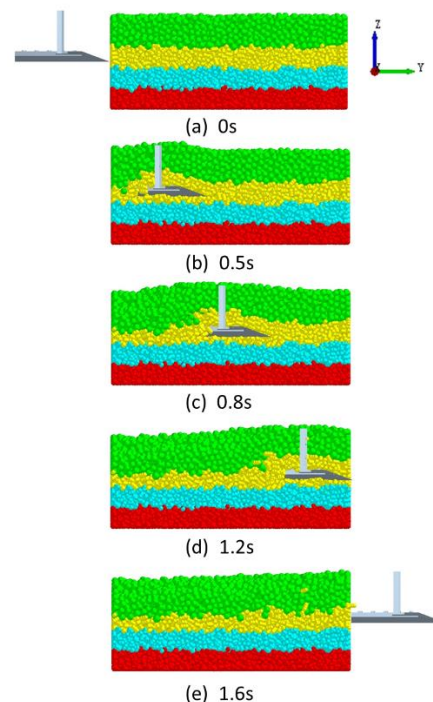

**Fig. 5** Arrow shovel longitudinal disturbance process  
As can be seen from Fig.5, when the arrow shovel starts to enter the soil model, the surface and shallow soil particles are arched up, and the middle and deep soil

particles are slightly displaced due to mutual extrusion between the particles. As the arrow shovel moves forward, some of the shallow soil particles move forward with the arrow shovel, and the surface soil basically does not move with the arrow shovel. It can be seen that the surface layer is less disturbed when the arrow shovel is used to loosen the grass, which is conducive to keeping the surface vegetation from being destroyed in a large area and effectively preventing soil erosion.

### 3.2 Soil disturbance efficiency analysis

Soil disturbance efficiency is an important data to measure the effect of arrow shovel on soil operation [13], and soil disturbance efficiency can be expressed as the percentage of the number of particles with kinematic velocity to the total number of particles in this category. After the arrow shovel completed the grass operation process, the distribution of the percentage of moving particles was derived in the discrete element software according to whether the particles had the motion speed or not, as shown in Figure 6.

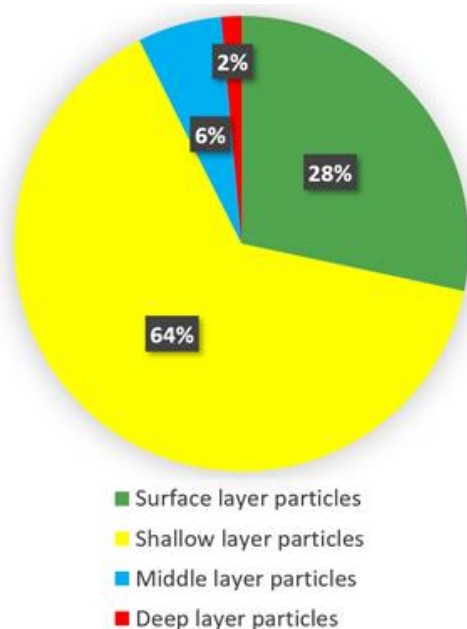

Fig.6 Distribution of the proportion of motion particles

From Fig. 6, When the arrow shovel has finished loosening the soil, The number of particles with kinematic velocity as a percentage of the total number of particles in the layer was 28%, 64%, 6% and 2%, respectively in surface, shallow, medium and deep particles. It can be seen that the arrow shovel mainly disturbs the shallow soil particles when loosening soil, and the shallow soil is disturbed with maximum efficiency, while the medium and deep soil are disturbed with lower efficiency, indicating that the arrow shovel has good effect of shallow loosening, which is especially suitable for the improvement and restoration of dry grassland with shallow soil layer.

### 3.3 Arrow shovel force analysis

The resistance suffered by the arrow shovel in the working process is closely related to the energy consumption, and the working resistance of the arrow shovel is a measure of the quality of the arrow shovel, and the analysis of the force state of the arrow shovel can provide a basis for the structural optimization of the arrow shovel [14]. After the simulation, the forces on the arrow shovel in the horizontal direction, vertical direction and forward direction during the motion of the arrow shovel were derived by using discrete element software, as shown in Figure 7.



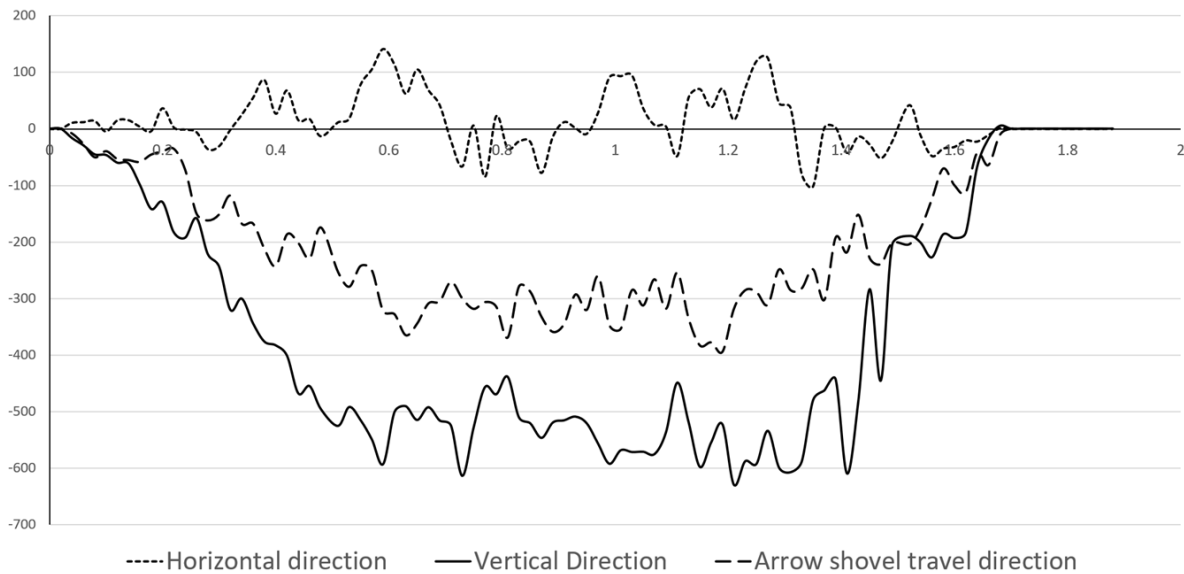

**Fig.7** The force of the arrow shovel in three directions

Fig.7 shows that when the arrow shovel enters the soil, the force in the vertical direction and the travel direction increases due to the increasing contact area between the arrow shovel tip and the soil, while the force in the horizontal direction shows an up-and-down trend and the force is small. In the process of traveling after the arrow shovel completely enters the soil model, the force on the arrow shovel decreases because some soil particles are separated from the surface of the arrow shovel, while other soil particles are arched by the arrow shovel, resulting in an increase in the force, at this time the force on the arrow shovel in the vertical direction and traveling direction fluctuates up and down, and the force in the vertical direction is greater than the force in the traveling direction. Only when the arrow shovel leaves the soil, the force will be gradually reduced.

The simulation results show that the force on the arrow shovel and the contact between the arrow shovel and the particles are directly related. The projection size of the arrow shovel in the vertical direction and the travel direction determines the number of particles in contact with the arrow shovel, which in turn affects the force on the arrow shovel. The projection size is affected by the shovel blade width, shovel blade length, shovel blade tension angle and loosening angle, which in turn is

directly related to the ease of entry of the arrow shovel into the soil, which in turn affects the travel resistance of the arrow shovel.

#### 4 Conclusion

(1) Using discrete element software, the loosening process of the arrow shovel is demonstrated visually by reasonably selecting soil parameters and setting soil particle models. The simulation shows that the surface layer is less disturbed when the arrow shovel loosens soil, which is conducive to keeping the surface vegetation from being destroyed in a large area and effectively preventing soil erosion.

(2) Discrete element simulation calculates that the disturbance efficiency of the arrow shovel on the surface, shallow, middle and deep soil particles is 28%, 64%, 6% and 2% respectively, which indicates that the arrow shovel has good effect of shallow loosening and is especially suitable for the improvement and restoration of dry grassland with shallow soil layer.

(3) The force analysis of arrow shovel shows that the resistance of arrow shovel is mainly the force of arrow shovel in the forward direction when it works. The resistance of the soil in front of the arrow shovel is closely related to the loosening angle, and the optimization of structural parameters is the key to

improve the resistance reduction effect of the arrow shovel.

### ACKNOWLEDGEMENT

We sincerely express our gratitude to Professor Cen for his careful teaching, which has played a great role in the smooth progress of this research work, and also expressed our gratitude to the Inner Mongolia Autonomous Region Science and Technology Major Project (2020ZD0002) for its financial support for this work

### References

- [1] Editorial Department, Liu Y. 2016 National Grassland Monitoring Report. China animal industry, 2017,8:18-35. (in Chinese)
- [2] Qi P Y. Causes of alpine grassland-like grassland degradation and its analysis. NONGJIACANMOU, 2021,24: 138-139. (in Chinese)
- [3] Zhou J, Qiao G H. Progress of research related to grassland degradation management. Agricultural Economy, 2020,07: 9-11. (in Chinese)
- [4] Wang Y Z, Dai L X, Liu X Y, Liu G, Wu G L. Discussion of the Grassland Situation and Approach of Ecological Restoration in China. Journal of Grassland and Forage Science, 2007,05: 29-32.
- [5] Yan Q Z. Impact of grassland degradation on livestock farming and measures to cope with it. Animals Breeding and Feed, 2020,12: 163-164.
- [6] Zhang J G. Effects of different improvement measures characteristics of community and soil of degraded grassland. Master dissertation. Inner Mongolia Autonomous Region: Inner Mongolia University,2017.
- [7] Željko Vaško, Gordana Rokvić. Economic valuation of grassland utilization improvement in the Western Balkans 2021. SHS Web of Conferences,2021,95, 01002.
- [8] Yang S K, Su Z F. SICAO SHENGCHAN JIXIE YU SHEBEI. China Agricultural Press,2009.
- [9] Hang C G. Soli disturbance behavior of subsoiling based on discrete element method. Master dissertation. Shaanxi: Northwest A&F University, 2018.
- [10] Pan T H, Du F, Wang Y. Analysis of root distribution and shear enhancement resistance of slope protection plants in loess areas of northern Shaanxi. Research of Soil and Water Conservation,2020,03:357-363.
- [11] Xin Z B, Niu Z R, Liu X M, and Yuan J. Study on Soil Disturbance Behavior of Globoid Subsoiling Shovel Based on Discrete Element Method. International Workshop of Advanced Manufacturing and Automation, 2018: 684-693.
- [12] Hang C G, Huang Y X, Zhu R X. Analysis of the movement behaviour of soil between subsoilers based on the discrete element method. Journal of Terramechanics,2017,74:35-43.
- [13] Zhou J, Ji D D, Li L J. Study on the Drag Reduction of Sub-soiling Shovel and Influence Factors of Tillage Resistance-Based on LS-DYNA. Journal of Agricultural Mechanization Research, 2019,4105: 157-162. (in Chinese)
- [14] Deng J Y. Simulation and experimental study of tillage resistance of deep loosening shovel based on discrete element method. Master dissertation. Heilongjiang Province: Heilongjiang Bayi Agricultural Reclamation University,2015.

## BIOGRAPHIES



Wei Huijun, male, born in December 1997, from Jincheng City, Shanxi Province, master's degree student.

Research interests: Introduction to intelligent equipment in agriculture and animal husbandry, agricultural machinery design.

E-mail: 1535192639@qq.com



Cen Haitang, born in October 1967, from Zhuozhi County, Inner Mongolia Autonomous Region, doctor, professor, mechanical engineering master's supervisor.

Research interests: digital design of forage harvesting machinery, introduction to intelligent equipment in agriculture and animal husbandry.

E-mail: 1054949591@qq.com