

# Automatic Tire Inflation System

Pauras Ghag<sup>1</sup>

<sup>1</sup>School of Mechanical Engineering, MITWPU, Pune, India

\*\*\*

**Abstract** - Tires have been modified on a regular basis since their discovery in order to improve their life and function in boosting automobile safety. As we all know, that vehicle is an essential part of our life, because it helps us travel miles in a few minutes. The tires' air pressure needs to be maintained at an ideal level for better vehicle running and for the safety of the vehicle. SO this project was brought into account by keeping into consideration the fuel consumption, vehicular safety and comfort. This system regulates vehicle tire pressure, enhancing fuel efficiency and decreasing tire wear; as a result, tire life is extended and tire replacement time and expense are reduced. One of the key goals of implementing this system is to maintain appropriate tire pressure. The pressure gauge monitors the tire pressure and inflates it when it falls below the desired amount. This paper explains how the "Automatic tire inflation system" works, as well as its benefits and drawbacks, for researchers and new learners.

**Key Words:** Improved Life, Vehicular Safety, Air Pressure, Fuel Efficiency, Advantages and Limitations, Automatic Tire Inflation System.

## 1. INTRODUCTION

Tires are the second most costly component for transportation firms. According to the American Automobile Association, 80% of cars have at least one underinflated tire among the others. According to their findings, when the tire pressure is less than two psi below the recommended pressure, fuel efficiency is lowered by 10%. [1]. In addition, according to studies conducted by the NACFE in 2013, an incorrectly inflated tire causes a vehicle to consume more fuel than is necessary. [1]. The natural movement of air through the elastic rubbers of tires also lowers the pressure. When there is a decrease in 10 degrees Fahrenheit of the surrounding temperature, the one psi pressure of the tire decreases. When tires make contact with the ground due to friction, heat is generated, which melts the tire's rubber, and underinflated tires get overheated easily. An underinflated tire engine has to work harder, thus taking more fuel to run the vehicle. Because climatic conditions differ from place to place, it's critical to maintain proper tire pressure to enhance fuel economy. Petrol and diesel are non-renewable energy sources, and many nations import gasoline/oil from Dubai and Oman owing to their availability. Under typical atmospheric circumstances, there is a monthly reduction of 0.5 to 1 psi tire pressure. The safety of the passengers, as well as the vehicle's fuel economy, tire life, and tire blowout reduction, are all important components of a vehicle. Fortunately, the automated tire inflation system greatly assists in the resolution of these problems. It adjusts for air

loss in the tire on a regular basis. As a result, by not manually checking tire pressure on a regular basis, the human effort is decreased.

Another benefit of incorporating this system is that it improves vehicle handling and control, lowering the risk of accidents. Air is delivered to the rotor assembly through flexible ducting and a rotating bearing, which inflates the tire. By maintaining ideal pressure in tires, braking and handling work at their best. When this system is installed, there will be no need for the driver or any passenger to check the pressure manually, thus reducing time and drudgery.

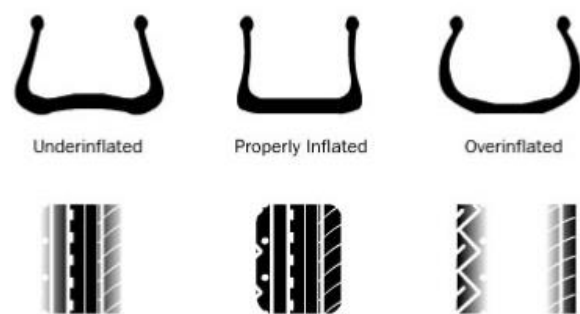

© 2000 How Stuff Works

## 1.1 PROBLEM STATEMENT

To design and construct an automated tire inflation system that inflates the tire when the pressure falls below the specified level.

Brief description of the problem

### A. Below problems are common:

1. Under-inflated tire
2. Maintaining wrong pressure in the tire

### B. Below parameters are affected:

1. Increased wear
2. Comfort
3. Handling
4. Fuel Economy

5. Frequent replacement of tires

### 1.2 OBJECTIVES AND SCOPE

**To maintain the required tire pressure:** The system's purpose is to keep and regulate the pressure in all of the system's tires in response to changing loads and driving circumstances.

**To have An Automatic System:** When tires are under-inflated, an automated system saves both human energy and time by replenishing them with air.

**To improve fuel efficiency & tire life:** This system helps in less consumption of fuel and improves tire life.

### 2. METHODOLOGY

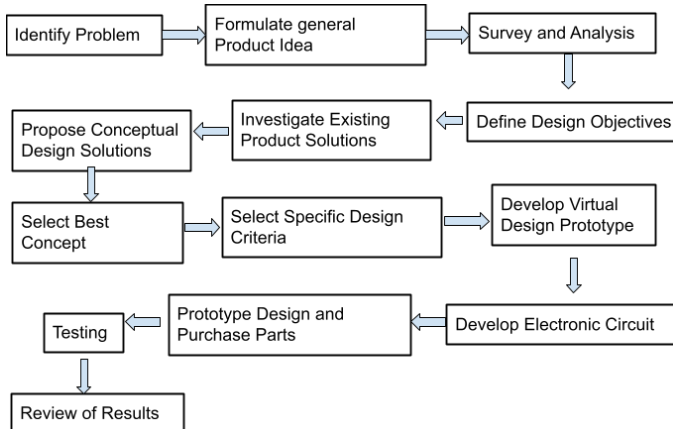

### 3. WORKING PRINCIPLE

This technique works because the compressor supplies air to the tire while the car is moving. The compressed air is delivered to the rotary joint, from which it is delivered to the tire, which is underinflated. Because of the rotational joint, air can be quickly delivered to the tire without tangles in the hoses [2]. When the proper tire pressure is attained, an automated small air compressor shuts off automatically. The compressor compresses the air in the automated tire inflation system, as indicated in fig. At the desired pressure, ambient air is compressed. The outflow of the compressor port is connected to the opposite end of the rotary joint by ducting. Ducting transports compressed air to the joint. Axle support is provided by two pedestal bearings. Nuts and bolts are used to attach the bearings to the stiff supports [3]. On one end, the axle spins around the rim or wheel. The axle is connected to one end of the coupler and the rotary joint to the other [4].

There are electronic sensors used to detect tire pressure with the help of a pressure gauge. When the tire pressure falls below the appropriate level, the sensors detect the drop in pressure and transmit a feedback signal to the compressor, The air pressure in the tire is maintained as a result of this. The reciprocating compressor is driven by the vehicle's 12V

battery [6]. As a result, reaching the desired pressure level is a simple task. When compressed air is necessary, the rotary joint is utilized to rotate and deliver pressurized air at the same time.

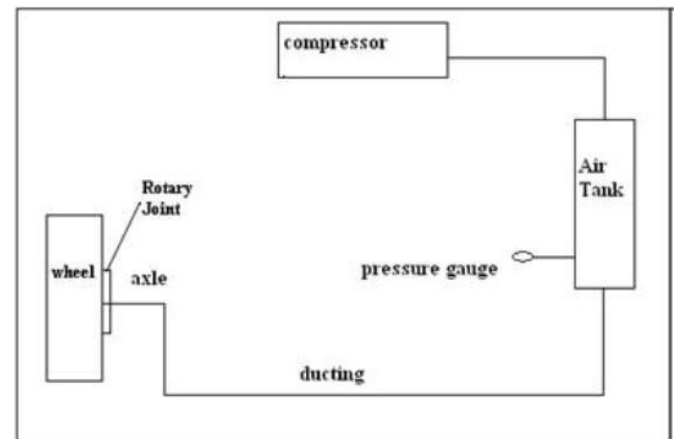

### 3.1 SPECIFIC DESIGN CRITERIA

#### DESIGN OF ROTARY JOINT:

**A]** A rotary joint, also known as a rotary union, allows fluid to flow into and out of spinning equipment from a stationary supply pipe.

**B]** The primary components of a rotary joint are:

- 1) Shaft
- 2) Bearings
- 3) Seals
- 4) Housing

**C]** In our design, two ball bearings were used to reduce contact friction between the two rotating parts and ensure smooth operation at higher RPMs.

**D]** To prevent air leakage, dynamic pneumatic seals – O rings are used and based on the requirements, appropriate O ring material was selected. In our prototype, we have used Nitrile, but during actual implementation, Viton or PTFE can be used.

**E]** The rotary joint was designed according to the axle diameter, standard-bearing dimensions and standard pneumatic seals available in the market.

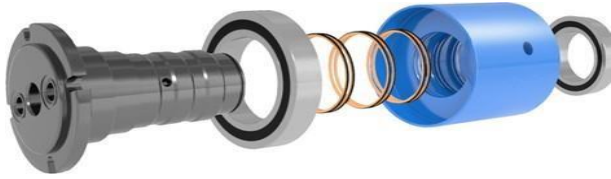

**ROTARY JOINT**

**SELECTION OF O - RING:**

Most of the O ring manufacturers refused to manufacture 8 O rings according to our design as they manufactured seals in bulk.

Hence, we had to select a standard O ring from the supplier's catalogue.

SIZE: I.D. X C.S.	NITRILE	NEOPRENE	SILICONE	VITON	EPDM
<b>SHORE HARDNESS:70</b>					
<b>PRICE PER NO.</b>					
55.8 x 1.6	18.90	24.30	24.90	36.60	24.30
56 x 2	19.20	25.20	26.10	42.30	25.20
56 x 3	21.00	27.60	29.70	63.00	27.60
58.2 x 3	21.30	27.90	30.00	64.20	27.90
58.42 x 2.62	20.40	26.70	28.20	55.20	26.70
58.5 x 3.3	20.20	27.20	28.50	57.50	27.20
58.5 x 5.33	40.20	53.70	60.30	167.70	53.70
59 x 3	21.30	27.90	30.00	64.80	27.90



**SELECTION OF BEARINGS:**

Designation	Principal dimensions					
	Bore d		Outside diameter D		Width B	
	mm	in	mm	in	mm	in
604	4	0.1575	12	0.4724	4	0.1575
607	7	0.2756	19	0.7480	6	0.2362
608	8	0.3150	22	0.8661	7	0.2756
609	9	0.3543	24	0.9449	7	0.2756
6000	10	0.3937	26	1.0236	8	0.3150
6001	12	0.4724	28	1.1024	8	0.3150
6002	15	0.5906	32	1.2598	9	0.3543
6003	17	0.6693	35	1.3780	10	0.3937
6004	20	0.7874	42	1.6535	12	0.4724
6005	25	0.9843	47	1.8504	12	0.4724
6006	30	1.1811	55	2.1654	13	0.5118
6007	35	1.3780	62	2.4409	14	0.5512
6008	40	1.5748	68	2.6772	15	0.5906
6009	45	1.7717	75	2.9528	16	0.6299
6010	50	1.9685	80	3.1496	16	0.6299
6011	55	2.1654	90	3.5433	18	0.7087
6012	60	2.3622	95	3.7402	18	0.7087
6013	65	2.5591	100	3.9370	18	0.7087

**CAD MODEL OF ROTARY JOINT:**

Because the in-motion tire inflator was designed for use by a local passenger car, the main stumbling block is the existence of an axle shaft that runs straight through the center of the wheel, necessitating the need of a separate system to channel air to the tire. A rotary joint with one half rotating with the driving axle hub and the other half stationary with the spindle is used to alleviate this problem. Air will be transported from the stationary joint to the spinning joint through an air chamber.

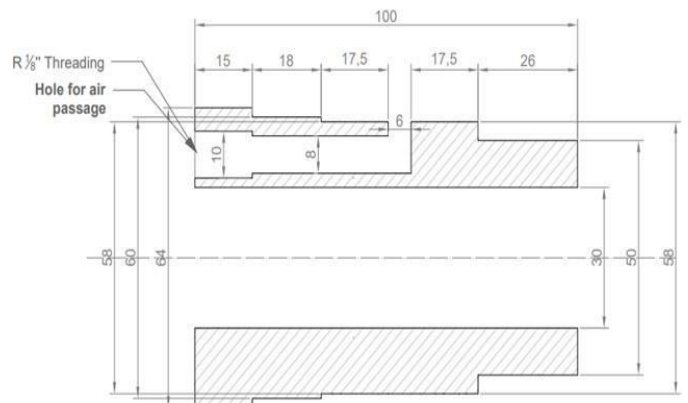
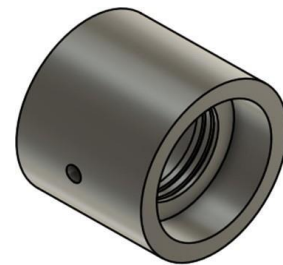
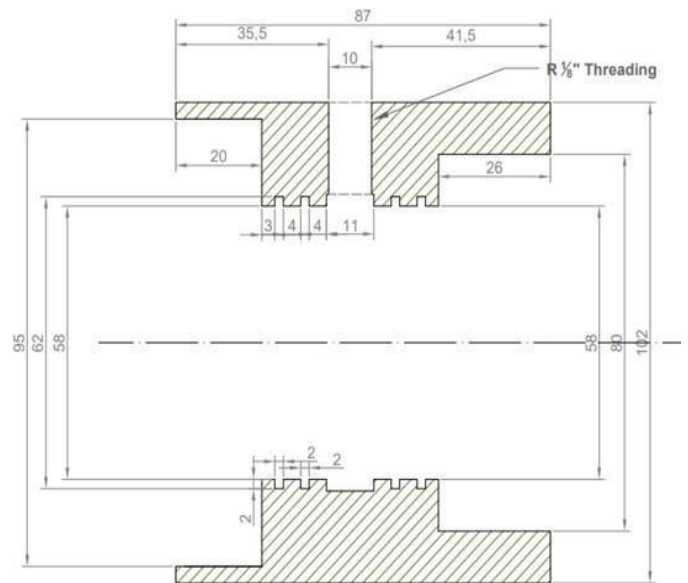

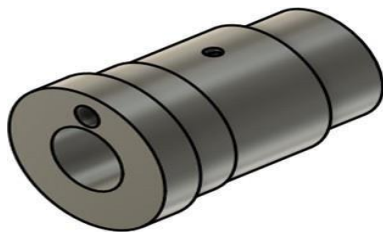

Sectional View and CAD of Outer and Inner Part of Rotary Joint

**ASSEMBLY OF ROTARY JOINT:**

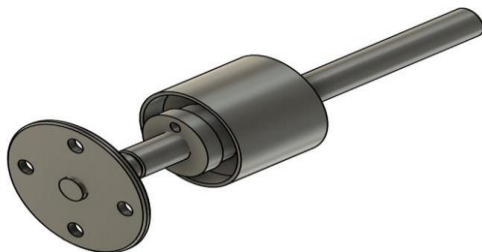

**CAD AND ACTUAL MODEL OF ASSEMBLY**

**3.2 PROPOSED SOLUTIONS**

The suggested system, which is primarily split into three elements, is depicted in the block diagram below:

Rotary Joint

Electronic Control Unit

Pneumatic Control Unit

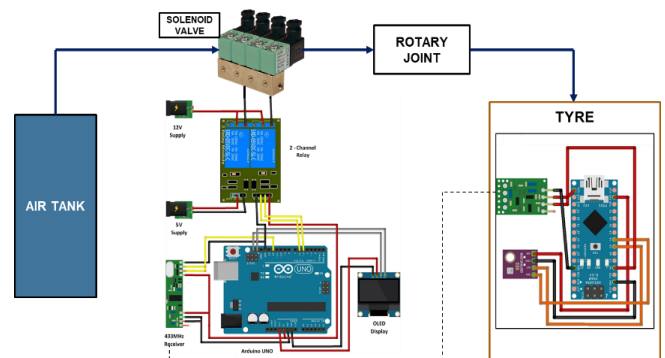
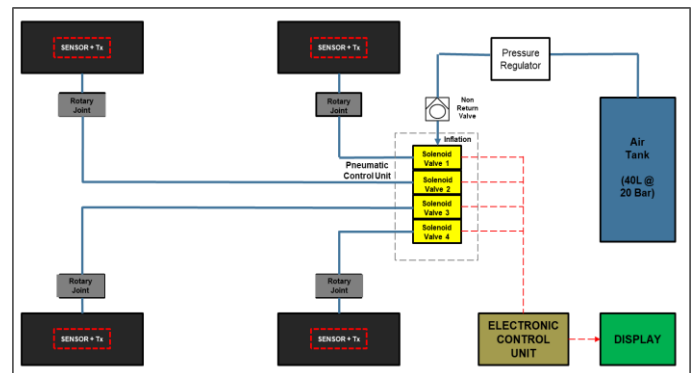

**3.2.1 TIRE PRESSURE MANAGEMENT**

The Arduino Nano, a 433MHz transmitter, and a 4000mAh battery are used in the proposed system. Tire inflation can be avoided by avoiding extremes in temperature and pressure [10]. The prior system's temperature and pressure limitations have also been extended, with temperatures ranging from 40 to 125 degrees Celsius and pressures ranging from 0 to 750 kilograms per square meter. The low-power TPMS is built using sensors, radio communication (RF), and a SoC unit. [11].

The sensor, along with Arduino Nano, battery and transmitter, is assembled and wired together and are kept in a small box. The box is held inside the wheel with the help of a steel band. The following figures show the inner side of the casing, which protects the battery, Arduino Nano, and wiring.

**SENSOR INSTALLATION**





### 3.2.2 ACTUAL SYSTEM

#### Transmitter Circuit

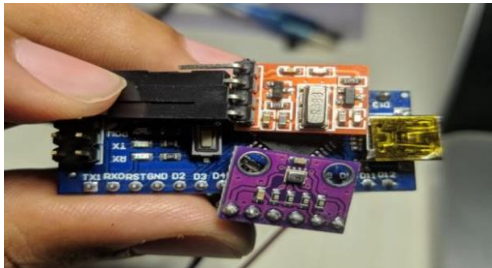

#### Receiver Circuit

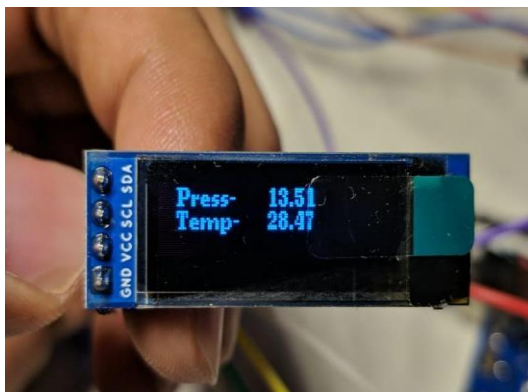
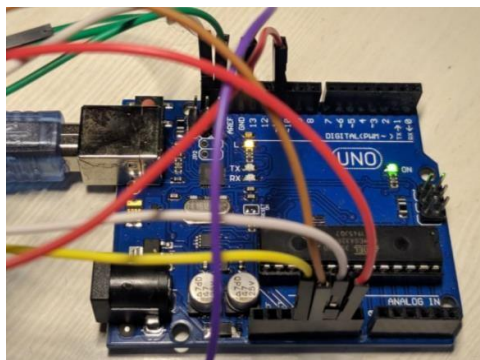

### 4. CONCLUSIONS

In conclusion, the in-motion tire inflator system can be realized using the rotary joint air transfer method. A lot of research and modification can be done before the system goes to perfection. As a novel product in the automotive supply industry, the in-motion tire inflator system has a good chance of succeeding. As mentioned earlier, the major advantage of this implementation in technology that will allow for tire pressure to be fit for driving conditions will be the owner of the vehicles.

They will experience a reduction in tire wear as well as an increase in fuel economy and efficiency, resulting in long-term cost benefits despite the initial investment in the technology [3].

### REFERENCES

- [1] Krishna Kumar Karothiya Manoj Kumar. "Design system of an automatic tire pressure inflation and deflation system". International Journal for Research in Engineering Application & Management (IJREAM) ISSN : 2454-9150 Vol-06, Issue-08, NOV 2020.
- [2] Ashish Shinde<sup>1</sup> Vishad Patil<sup>2</sup> Ashish Mane<sup>3</sup> Shubham Pawar<sup>4</sup> Prof. Aniket Deshmukh<sup>5</sup>. "Automatic Tire Inflation Systems - A Review". IJSRD - International Journal for Scientific Research & Development| Vol. 6, Issue 02, 2018 | ISSN (online): 2321-0613.
- [3] 1Prof. P.M. Borade, 2Gopinath Keskar, 3Yash Girme, 4Digambar Ghevade, 5Akshay Shelke. "CENTRAL TIRE INFLATION SYSTEM". ISSN: 2455-2631 © June 2017 IJSRD | Volume 2, Issue 6.
- [4] Harshal Junankar<sup>1</sup> Vishnusagar Bihare<sup>2</sup> Nishant Giradkar<sup>3</sup> Chetal Gupta<sup>4</sup>. "A Review: Automatic Tire Inflation System". IJSRD - International Journal for Scientific Research & Development| Vol. 3, Issue 01, 2015 | ISSN (online): 2321-0613
- [5] 1Prabhakar N 2Pranil Sakinal 3Varad Tamhankar 4Rutika Sakore. "RATIS (Rapid Automatic Tire Inflation System)". IOSR Journal of Engineering (IOSRJEN) www.iosrjen.org ISSN (e): 2250-3021, ISSN (p): 2278-8719 Special Issue || September 2021|| PP 01-15 7th National Conference On Advancements in Communication, Computing and Electronics Technology-ACCET 2021.
- [6] 1Apurav Hinge 2Puspendra Upadhyay. "A REVIEW STUDY ON SELF INFLATED TIRE SYSTEM". NOVATEUR PUBLICATIONS International Journal of Innovations in Engineering Research and Technology [IJIERT], ISSN: 2394-3696 Conference Proceedings of i - Mechanical Engineering Students Conference 2018 (i - MESCON 18) 28th December, 2018
- [7] Prof. Miss. Shingavi Archana Ashoklal<sup>1</sup> Mr. Bachkar Arvind Nanasahab<sup>2</sup> Mr. Domade Ananda Chindhu<sup>3</sup> Mr. Pote Suyog Kantaram<sup>4</sup> Mr. Somwanshi Sachin Vitthal<sup>5</sup>. "Air Filling in Moving Tire" - IJSRD. IJSRD - International Journal for Scientific Research & Development| Vol. 4, Issue 01, 2016 | ISSN (online): 2321-0613
- [10] Balaji, K., Madhav, B.T.P., Syam Sundar, P. and Rakesh Kumar, P. (2011) "Tire Pressure Monitoring and Communicating Antenna in the Vehicular Systems". International Journal of Advances in Engineering & Technology, 1, 422-428.
- [11] A. Vasantharaj<sup>1</sup>, K. Krishnamoorthy<sup>2</sup>. "Tire Pressure Monitoring System Using SoC and Low Power Design". Circuits and Systems, 2016, 7, 4085-4097 <http://www.scirp.org/journal/cs> ISSN Online: 2153-1293 ISSN Print: 2153-1285