

Heat Transfer through Various Perforated Fin Arrays

Rufzan Haneesh¹, Sachin Gopakumar¹, Sooraj¹, Subin Varghese¹

¹UG Student, Dept. of Mechanical Engineering, Mangalam College of Engineering, Ettumanoor, Kerala, India

Abstract - Extended surfaces known as fins are widely used in various industrial or domestic applications such as Electronic equipment, heat exchangers and space vehicles as a means to wipe the excess heat produced in components. In all these applications improvement in the efficiency of the heat transfer enhancement in fins can lead to substantial cost, space and material savings. Hence considerable research work has been done in the past to seek effective ways to improve the efficiency of fins. There are various types of fins but rectangular plate fins are commonly used due to simplicity in manufacturing. Natural convection from a block with fins may be used to simulate a wide variety of engineering applications as well as provide better insight into more complex systems of heat transfer such as heat exchangers, refrigerators and electric conductors. Convection heat transfer may be enhanced by using perforated fins instead of solid fins with optimum angle of inclination of the fins. All electronic equipment relies on the flow and control of electrical current to perform a variety of functions. Whenever electrical current flows through a resistive element heat is generated. Regarding the appropriate operation of the electronics, heat dissipation is one of the most critical aspects to be considered when designing an electronic enclosure. Rectangular fins are used extensively to increase the rates of natural convection heat transfer from systems, because such fins are simple and cheap to manufacture. Here we code validate values to find which perforation provides better heat transfer coefficient.

Key words: Fins, Code validate, Heat transfer coefficient.

1. INTRODUCTION

The fins are extended surfaces which increase the heat transfer rate by increasing the area of heat transfer. Fins are used in automobile engines, heat exchangers, refrigerators, transformers, electronic devices etc. In many industrial applications the free convection cooling by air is most widely utilized because they are inexpensive, more reliable, light in weight and easy to manufacture. Although the forced convection has higher heat transfer coefficient as compared to the natural convection, the manufacturing and operating cost will increase significantly and the weight and noise will also increase. Therefore, natural convection is better for most of the applications.

'Cooling fins' are projections that increase the surface area from which heat can be radiated away from a device. The fins project outwards making the area for emitting heat back into, say, an electronic circuit's container, smaller

than the area emitting heat to the outside environment. Natural convection heat transfer rate can be increased by increasing the fin area but at the cost of increased weight, bigger size and higher cost of fins. Performance of the fins in terms of heat transfer rate with reduction in size, cost and weight of fins can be achieved by making certain changes in the geometry. By the use of perforated fins the heat transfer coefficient can be enhanced with reduction in weight and cost of fins. For a number of industrial applications, heat generation can cause overheating which occasionally leads to system failure. To overcome this problem, efficient heat sinks are essential. Free convection from these devices is a commonly used cooling technique and plays an important function in preserving proper operation. Fins as heat transfer enhancement devices have become quite common. As extended surface technology continues to grow, new design ideas come forth, including fins made of different geometrical perforations.

2. LITERATURE SURVEY

Some of the journals used as reference for base values and code validation are given below:

2.1 "An experimental investigation of natural convection heat transfer enhancement from perforated rectangular fins array at different inclinations" by Umesh V. Awasarmol, Ashok T. Pise b

Compares the natural convection heat transfer enhancement of perforated fin arrays with different perforation diameter (4–12 mm) and at different angles of inclination (0–90). The increase in the heat transfer coefficient was achieved with perforated fins of 12mm perforation diameter at the angle of orientation 45.

2.2 "Enhancement of natural convection heat transfer from rectangular fins by circular perforations" by Wadhah Hussein, Abdul Razzaq Al-Doori

Drop in temperature between the fin base and the tip increased as the diameter of the perforations increased.

2.3 "Enhancement of natural conv. heat transfer from a fin by rectangular perforations" by Abdullah H.

Aimed mainly at examining the extent of heat transfer enhancement from a horizontal rectangular fin under natural convection conditions as a result of introducing body modification (perforations) to the fin body.

3. FORMULATION OF METHODOLOGY

As the size of the electric and electronic devices reduces, making them compact and better performing ones leads to the high heat flux developed in small areas. Thus we should go for better cooling technologies and devices in order to dissipate this heat load efficiently

To investigate the effect of various fins perforations in different positions (ordered and zig-zag) shape on the natural convection heat transfer from horizontal rectangular fin arrays.

In order to do that first we have designed the component using the designing software. Here we used Autodesk Fusion 360 software. In the software, first we made a rectangular shape of dimension 35mm*75mm. Then it was extruded to a height of 5 mm. Then we sketched the fins on the face of the rectangular we made and extruded it to a height of 26mm. Now we got our fin without perforations. Now we can sketch our preferred perforation shape in the plane of fins and cut it. After that we will be moving the fins to the Fluent 15 software. There we meshed the fin with a tetrahedral type of meshing. Then we added the boundary conditions into the meshed geometry, and results were taken and analysed.

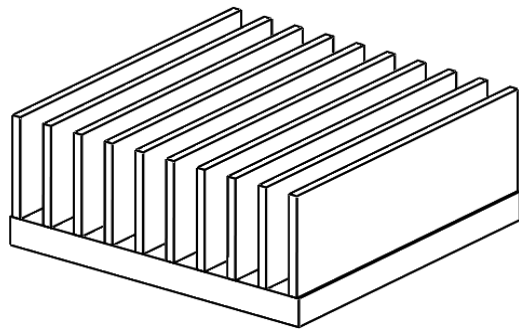

Fig 1. Solid fin arrays

As the shape of perforation changes, the heat transfer also changes. We can analyse the changes with the help of the software.

3.1 Problem specifications

In our study we have considered rectangular fin arrays with and without perforation. Initially the analysis was carried out on solid fins and then for perforated types. The number of fin arrays considered is 10. At the base of the block the heat input is given and it is being transported to the surfaces till fin tip due to conduction. However, convection currents start in a convective atmosphere. Let the specification of fin arrays be;

- L - fin length = 75mm
- H - fin height = 25mm
- S - fin spacing = 6mm
- T - thickness = 2mm

First we consider rectangular fin arrays without perforations. Then after that we will be considering fins with perforation on it. The perforations we used are circular, elliptical, rectangular and triangular. The areas of these perforations will be kept constant. For example if we are considering a circle of diameter 4mm, the area of the circle will be $12.56mm^2$. So in order to make all the areas same, we will find out the dimensions of ellipse, rectangle and triangle from the area $12.56mm^2$. Thus we will get the values as a and b of the ellipse as 1 mm and 4 mm, side of the square as 3.54 mm, side of the triangle as 5.4 mm. Thus we will create perforations of the same areas for doing our research using ansys fluent 15 software.

4. FORMULATION OF WORK PLAN

For doing our work we are considering rectangular fins. The number of fins on it are 10. For rectangular fins the size of the base blocks are taken as 75mm in length and 35mm in width. The thickness of the fins are considered as 7 mm. The spacing between fins is taken as 6mm. And then we have extruded the fins to a height of 25 mm. In order to do our simulation work, we have to specify the air domains surrounding the fins. So we selected the air domains as 42mm from the base of the block.



Fig 2. Rectangular fin



Fig 3. Radial fin



Fig 4. Pin fin

4.1 Work steps

1. Need to study how heat transfer is affected when perforations are changed so as to design a better fin array system.
2. Did literature survey.
3. Selected a journal to start the work.
4. CFD simulation.
5. Optimising perforation of fins.

4.2 Assumptions

- Steady state
- Laminar and incompressible flow

- Negligible radiation heat transfer
- Buoyancy approximation for fluid
- Gravitational effects are considered

5. CFD ANALYSIS

Computational Fluid Dynamics (CFD) is the science of determining the numerical solution of the governing equation for the fluid flow through space or time to obtain a numerical description of the complete flow field of interest. The equation can represent steady or unsteady, Compressible or Incompressible, and in viscid or viscous flows, including non ideal and reacting fluid behavior. The particular form chosen depends on the intended application.

After the model is imported in the CFD domain, the next step is to mesh the domain. To perform better results using CFD tools it was mandatory to use better quality of mesh hence the meshing of the model is generated and the naming of the section is given in the model for computing purpose.

5.1 Analysis steps

5.1.1 Pre processing

1. Defining the geometry
2. Meshing the geometry
3. Defining boundaries and continuum types

5.1.2 Processing

1. Setting the model
2. Specifying boundary condition
3. Initialization
4. Solving

5.1.3 Post processing

1. Analyzing the result.

5.1.1 Pre processing

In the pre-processing step, we are processing the geometry completely, making it capable of entering the simulation. For that we have to define the geometry first. Then we have to mesh the geometry. Meshing is an integral part of the computer-aided engineering (CAE) simulation process. The mesh influences the accuracy, convergence and speed of the solution. Furthermore, the time it takes to create a mesh model is often a significant portion of the time it takes to get results from a CAE solution.

One of the purposes of meshing is to actually make the problem solvable using Finite Element. By meshing, you break up the domain into pieces, each piece representing

an element. Last step in pre-processing is defining boundaries and continuum types. an approach based on the view that behavior ranges over a continuum from effective functioning to severe abnormality. It assumes that differences between people's behavior are a matter of degree rather than kind. As the second step we will set up the mode and will be defining the boundary conditions and solving: Before starting your CFD simulation, you must provide ANSYS Fluent with an initial "guess" for the solution flow field. In many cases, you must take extra care to provide an initial solution that will allow the desired final solution to be obtained easily. After that we will proceed to the analysis of the result where we analyse the datas obtained from the software.

Table1. Dimensions

Sl no	Circle (mm) d	Area (mm^2) A	Ellipse (mm) a	Ellipse (mm) b	Triangle (mm) a	Square (mm) a
1	4	12.56	1	4	5.4	3.54
2	6	28.26	2	4.5	8.1	5.31
3	8	50.24	3	5.33	10.8	7.08
4	10	78.5	4	6.25	13.51	8.86
5	12	113	5	7.2	16.21	10.63

First we consider rectangular fin arrays without perforations. Then after that we will be considering fins with perforation on it. The perforations we used are circular, elliptical, rectangular and triangular. The areas of these perforations will be kept constant. For example if we are considering a circle of diameter 4mm, the area of the circle will be $12.56mm^2$. So in order to make all the areas same, we will find out the dimensions of ellipse, rectangle and triangle from the area $12.56mm^2$. Thus we will get the values as a and b of the ellipse as 1 mm and 4 mm, side of the soiree as 3.54 mm, side of the triangle as 5.4 mm. Thus we will create perforations of the same areas for doing our research using ansys fluent 15 software.

Table 2. Configuration

Geometry code	Number of rows	Number of Holes	Type
2R1	2	6	Ordered
2RZ	2	5	Zig-zag

The very next step after creation of the geometry is the meshing of the geometry. Here we used tetrahedral meshing using Ansys fluent 15 software.

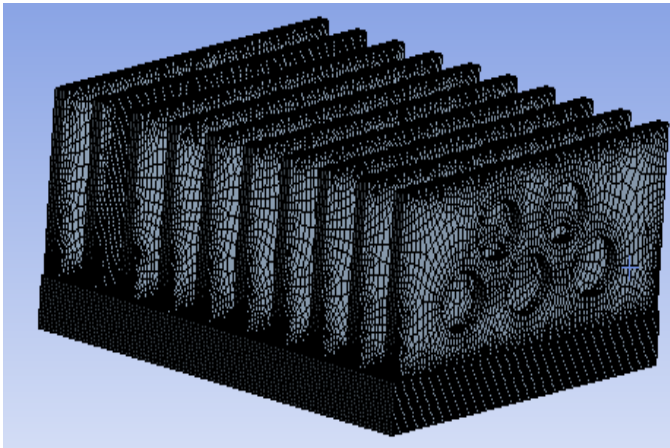

Fig 5. Meshing and processing

Meshing is the process in which the continuous geometric space of an object is broken down into thousands or more shapes to properly define the physical shape of the object. The more detailed a mesh is, the more accurate the 3D CAD model will be, allowing for high fidelity simulations. One of the purposes of meshing is to actually make the problem solvable using Finite Element. By meshing, you break up the domain into pieces, each piece representing an element.

Meshing is an integral part of the computer-aided engineering (CAE) simulation process. The mesh influences the accuracy, convergence and speed of the solution. Furthermore, the time it takes to create a mesh model is often a significant portion of the time it takes to get results from a CFD tool. The meshing power tool provides a tool for determining whether a geometry can be meshed using autoscheme, or if it requires its scheme to be set explicitly.

5.2 Processing

● Governing equation

1. Continuity equation $\frac{\partial u}{\partial x} + \frac{\partial v}{\partial x} + \frac{\partial w}{\partial x} = 0$

2. Navier-Stokes Equation (Momentum equation)

Along x direction $[\frac{\partial u}{\partial t} + u\frac{\partial u}{\partial x} + v\frac{\partial u}{\partial y} + w\frac{\partial u}{\partial z}] \times \rho = -\frac{\partial p}{\partial x} + \rho g_x + \mu[\frac{\partial^2 u}{\partial x^2} + \frac{\partial^2 u}{\partial y^2} + \frac{\partial^2 u}{\partial z^2}]$

Along y direction $[\frac{\partial v}{\partial t} + u\frac{\partial v}{\partial x} + v\frac{\partial v}{\partial y} + w\frac{\partial v}{\partial z}] \times \rho = -\frac{\partial p}{\partial y} + \rho g_y + \mu[\frac{\partial^2 v}{\partial x^2} + \frac{\partial^2 v}{\partial y^2} + \frac{\partial^2 v}{\partial z^2}]$

Along z direction $[\frac{\partial w}{\partial t} + u\frac{\partial w}{\partial x} + v\frac{\partial w}{\partial y} + w\frac{\partial w}{\partial z}] \times \rho = -\frac{\partial p}{\partial z} + \rho g_z + \mu[\frac{\partial^2 w}{\partial x^2} + \frac{\partial^2 w}{\partial y^2} + \frac{\partial^2 w}{\partial z^2}]$

3. Energy equation $\frac{\partial T}{\partial t} + u\frac{\partial T}{\partial x} + v\frac{\partial T}{\partial y} + w\frac{\partial T}{\partial z} = \alpha[\frac{\partial^2 T}{\partial x^2} + \frac{\partial^2 T}{\partial y^2} + \frac{\partial^2 T}{\partial z^2}] + \phi$

- u,v,x -x,y,z components of velocity
- φ-dissipation function
- α-diffusion coefficient

In fluid dynamics, the continuity equation states that the rate at which mass enters a system is equal to the rate at which mass leaves the system plus the accumulation of mass within the system

Navier-Stokes equation, in fluid mechanics, a partial differential equation that describes the flow of incompressible fluids. The equation is a generalization of the equation devised by Swiss mathematician Leonhard Euler in the 18th century to describe the flow of incompressible and frictionless fluids.

The energy equation is a statement of the conservation of energy principle. In fluid mechanics, it is found convenient to separate mechanical energy from thermal energy and to consider the conversion of mechanical energy to thermal energy as a result of frictional effects as mechanical energy loss.

Properties of materials used

Table 3 .Properties of Air

DESCRIPTION	VALUE	UNITS
Viscosity	1.789 x 10 ⁻⁵	kg/m-s
Density	1.225	kg/m ³
c-Specific heat capacity	1006.43	J/kg-K
k-Thermal conductivity	0.0242	W/m-K

Table 4. Properties of Aluminium

DESCRIPTION	VALUE	UNITS
Density	2719	kg/m ³
c-Specific heat capacity	871	J/kg-K
k-Thermal conductivity	202.4	W/m-K

- Here we consider air as fluid and aluminium as material for fins. Al is considered as it has good thermal conductivity.

- The above values were taken from the reference journal by Umesh. V.

Boundary condition

Table 5. Boundary conditions

Boundary name	Type
Air inlet	Atmospheric temperature of 288.02 K and at a velocity of 0.1 m/s.
Air outlet	Pressure outlet (gauge pressure= 0, atmospheric temperature of 288.02 K)
Air - Aluminium interface	$T_{solid} = T_{fluid}$
Soil outer surface	Wall (300 K)
Base of block	$q(\text{Heat influx}(3560\text{W}/\text{m}^2 \text{ and } 5300\text{W}/\text{m}^2))$

Numerical methodology

Table 6. Numerical methodology

Flow	Steady, Laminar
Algorithm	SIMPLE
Software used	FLUENT 15

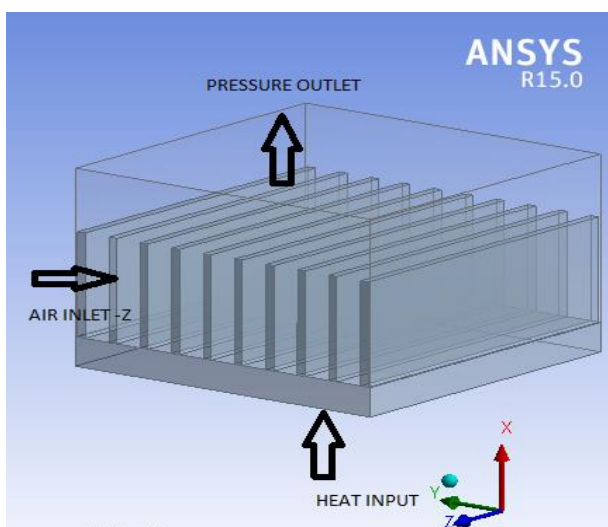

Fig 6. Air flow through fins

As the air is passed through the fins by natural convection, the flow is considered laminar with velocity 0.1 m/s. The heat is transmitted on to the surface of the fins from the application part. The air enters and flows through the surface of the fins absorbing the heat on its surface. The pressure we consider for simulation is of gauge pressure 0. Also the temperature considered is an ambient temperature of 288.02 K.

6. RESULTS

6.1 Code validation

Here code validation means we compare the values which were gained by experiment on the reference paper and the values which are gained through software simulation. We consider values between two points $3560\text{W}/\text{m}^2$ and $5300\text{W}/\text{m}^2$ for code validation.

Heat flux - Heat Flux is defined as the rate of heat energy that passes through a surface. Depending on the exact definition of heat flux. Its unit can be expressed as either W/m^2 or W.

Heat transfer coefficient - Heat transfer coefficient is a quantitative characteristic of convective heat transfer between a fluid medium and the surface (wall) flowed over by the fluid. Its unit can be expressed as $\text{W}/(\text{m}^2 \text{K})$.

Here we plot graphs between Heat flux and Heat transfer coefficient to code validate solid fin arrays and perforated fin arrays. The graphs we obtain are as follows.

Heat flux v/s Heat transfer coefficient

- Experimental
- Simulation

6.1.1 Solid fin code validation

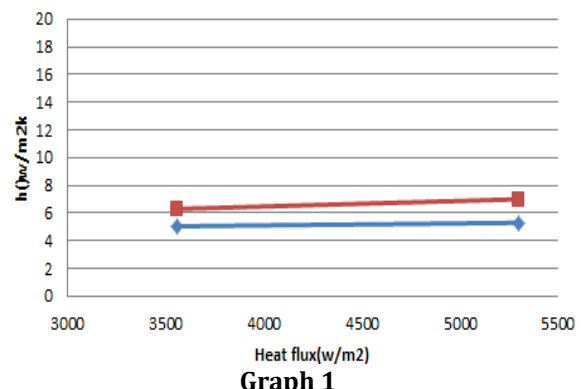

The heat transfer coefficient is almost similar between

heat flux $3560\text{W}/\text{m}^2$ and $5300\text{W}/\text{m}^2$ while code validating solid fins.

6.1.2 Perforated fin code validation

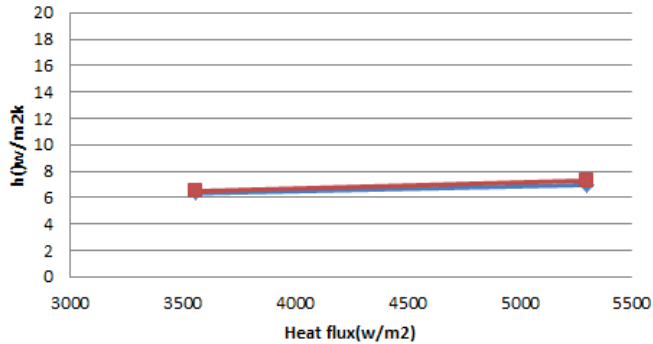

Graph 2

The heat transfer coefficient is almost similar between heat flux $3560\text{W}/\text{m}^2$ and $5300\text{W}/\text{m}^2$ while code validating perforated fins.

Following are the graphs we plotted from our results

6.2 Two Row Ordered Perforations (2RI)

6.2.1 Circular 2RI perforation

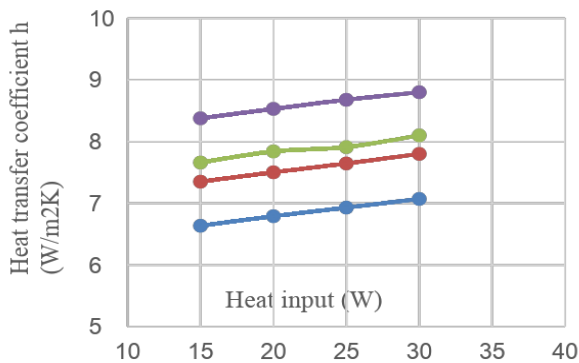

Graph 3

- Solid fin
- a = 8 mm
- a = 10 mm
- a = 12 mm

Here we can see that as the diameter of the circle increases, the heat transfer coefficient also increases. That means heat transfer increases with increase in circle diameter.

6.2.2 Elliptical 2RI perforations

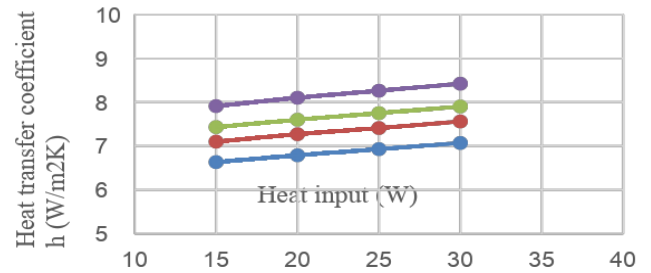

Graph 4

- Solid fin
- a = 3 mm , b = 5.33 mm
- a = 4 mm , b = 6.25 mm
- a = 5 mm , b = 7.25 mm

Here, as the elliptical perforation becomes larger, the heat transfer coefficient also increases as the heat transfer increases.

6.2.3 Square 2RI perforations

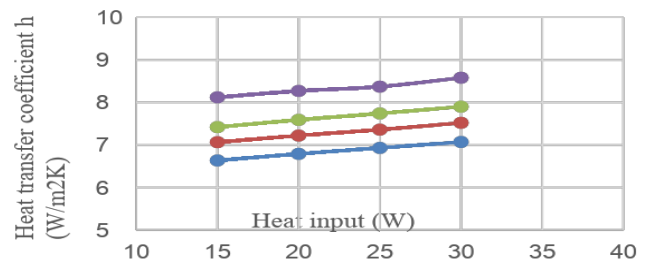

Graph 5

- Solid fin
- a = 7.08 mm
- a = 8.06 mm
- a = 10.6 mm

In the case of square, as the size of perforation increases, heat transfer also increases.

6.2.4 Triangular 2RI Perforations

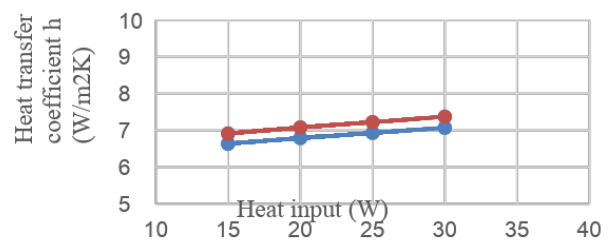

Graph 6

- Solid fin
- a = 10.8 mm

Here, as the triangle perforation becomes larger, the heat transfer coefficient also increases as the heat transfer increases.

6.3 Two Row Zig-zag Configurations (2RZ)

6.3.1 Circular 2RZ perforations

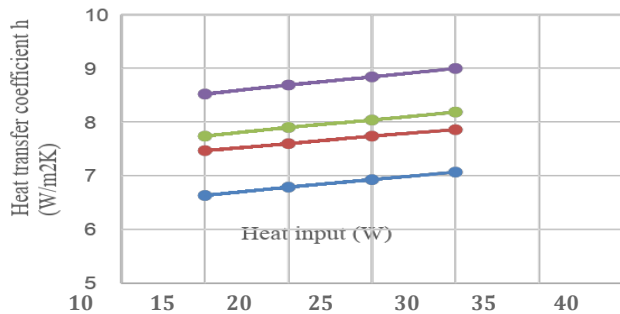

Graph 7

- Solid fin
- a = 8 mm
- a = 10 mm
- a = 12 mm

Here we can see that as the diameter of the circle increases, the heat transfer coefficient also increases. That means heat transfer increases with increase in circle diameter.

6.3.2 Elliptical 2RZ Perforations

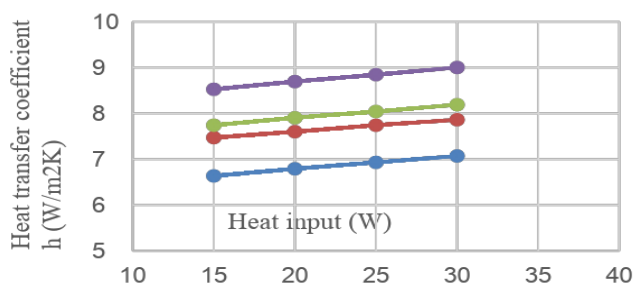

Graph 8

- Solid fin
- a = 3mm , b = 5.33mm
- a = 4mm , b = 6.25mm
- a = 5mm , b = 7.25mm

Here, as the elliptical perforation becomes larger, the heat transfer coefficient also increases as the heat transfer increases.

6.3.3 Square 2RZ Perforations

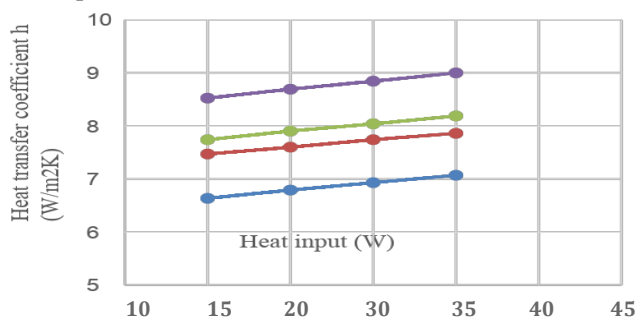

Graph 9

- Solid fin
- a = 7.08 mm
- a = 8.06 mm
- a = 10.6 mm

In the case of square, as the size of perforation increases, heat transfer also increases.

6.3.4 Triangular 2RZ Perforations

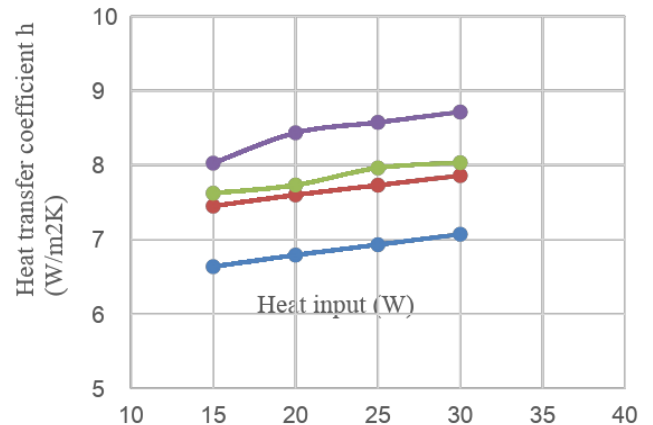

Graph 10

- Solid fin
- a = 10.8 mm
- a = 13.5 mm
- a = 16.21 mm

Here, as the triangle perforation becomes larger, the heat transfer coefficient also increases as the heat transfer increases.

6.4 EFFECT OF HEAT INPUTS

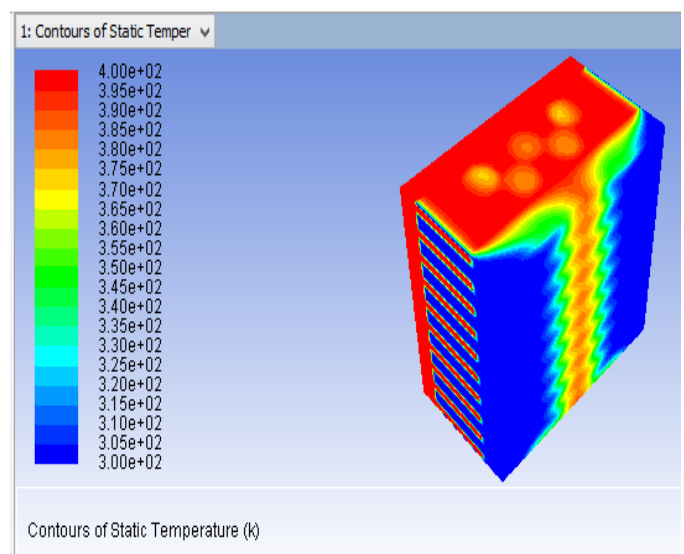

Fig 7. Contours of static temperature

Temperature developed in the fin arrays will be high as we go for higher heat fluxes (2670 W/m², 3560W/m², 4400W/m² and 5300W/m²).

ΔT for all the perforated fins is less as compared to solid fin arrays.

7. CONCLUSIONS

- The perforated fins increase the heat dissipation rates.
- For circular diameter perforation of 12 mm heat transfer coefficient was seen better and that quantity didn't change for the same perforation area for elliptical and square perforations. Nevertheless, Triangular Perforation doesn't show any similar values for this area.
- For perforated area corresponds to 10 mm, elliptical perforated fins showed better performance than all other configurations due to its rise of heat transfer per unit volume. Triangular perforation showed less heat transfer when it was perforated.
- Enhancement in heat transfer coefficient is 32%. The fin arrays considered in this study reveal that there is a strong relation between mass removed and heat transfer enhancement.
- Use of permeable fins not only enhances the heat transfer but also makes the fin array lightweight and compact. Thus the cost of fin material is saved with the use of permeable fins.

REFERENCES

- [1] **Umesh V. Awasarmol, Ashok T. Pise b,** (2015), "An experimental investigation of natural convection heat transfer enhancement from perforated rectangular fins array at different inclinations". *Experimental Thermal and Fluid Science (EXP THERM FLUID SCI)*.
- [2] **Wadhah Hussein, Abdul Razzaq Al- Doori** , (July-December 2011). "Enhancement of natural convection heat transfer from rectangular fins by circular perforations". ISSN: 2229-8648 (Print); ISSN: 2180-1606 (Online); Volume 4, pp. 428-436.
- [3] **Abdullah H. Al Essa et. al,** (2009) "Enhancement of natural convection heat transfer from a fin by rectangular perforations with aspect ratio of two, *Int. J. Phy. Sci.* 4 (10) 540–547. I. S. Jacobs and C. P. Bean, "Fine particles, thin films and exchange anisotropy," in *Magnetism*, Issue III, March 2015.vol. III, G. T. Rado and H. Suhl, Eds. New York: Academic, 1963, pp. 271–350.
- [4] **Kavita H. Dhanawade A et al.** "Thermal Analysis of Square and Circular Perforated Fin Arrays by Forced Convection" , E-ISSN 2277 – 4106, P-ISSN 2347 – 5161 ©2014 INPRESSCO.

- [5] **Dhanawade Hanamant S et al.** "Natural convection heat transfer flow visualization of perforated fin arrays by cfd simulation". *International Journal of Research in Engineering and Technology* eISSN: 2319-1163 | pISSN: 2321-7308.