

POWER GENERATION BY THERMOELECTRIC GENERATOR AND HOME AUTOMATION USING DTMF

VIBHANSHU BHARDWAJ¹, SAURABH KUMAR², PIYUSH KUMAR³, SUSHANT KUMAR⁴, DR. ANKIT GUPTA⁵, NIKHIL GUPTA⁶

¹⁻⁴Student, Department of Electrical Engineering, Greater Noida Institute of Technology

⁵Assistant professor, Department of Electrical Engineering, Greater Noida Institute of Technology

⁶H.O.D., Department of Electrical Engineering, Greater Noida Institute of Technology, Uttar Pradesh, India

Abstract – In this current scenario research on renewable sources of energy is a major concern as the replacement to the high demand for fossil fuels. Solar energy has been already concerned and a popular source to convert solar energy into electrical energy. According to an estimate about 66% heat wastes in power plants, automobiles, factories and in waste incinerator. Thermoelectric generators (TEG) can convert heat energy into electrical energy. It works on temperature difference. This is made possible by seeback- effect. As we are living in the modern world of technology and in every field, automation is used as an efficient tool in order to provide additional features. This project is based on thermoelectric generator with an additional feature of automation using DTMF (DUAL TONE MULTI FREQUENCY) module. In this project we are going to make automated home power system in which TEG output will be use as the input to the DTMF module (IC MT8870).

Key Words: Thermo electric generators, seeback effect, DTMF module, Automated home power system, IC MT8870.

1.INTRODUCTION

According to the world bank figure 759 million people lack access to electricity. However, under current planned policies and further affected by the covid-19 crisis, an estimated 660 million people would still lack access in 2030, most of them in sub-Saharan Africa.

This is our motivation for choosing this project. By using thermoelectric generator, it is possible to develop independent electric energy source in burning and heating systems-in households and industrial heating. By this proposed system it is possible to generate electricity at a household kw-h level and easier to provide electricity in villages and remote areas. As we know that in rural areas earth stoves are used so a large amount of heat wastes, by this waste heat electricity can be generated and it can solve the problem of power cut in rural areas and also reduce the electricity bill which is increasing in an exponential way.

First of all, thermoelectric generator designed by the series and parallel combination of peltier modules. Output of the TEG module passed through a buck boost converter and then given to 12v battery, output of the battery is directly

connected to the inverter circuit which convert 12v DC to 220v AC, After that DTMF module containing IC MT8870 is connected to the relay driver circuit using optocouplers(PC 817) which is directly connected to the load, Auxiliary cable of a mobile phone is connected which receives the DTMF encoded signal and decoded by DTMF module which gives instruction to relay module which accordingly turn On or off the load.

2.LITERATURE REVIEW

The literature related to this project thermoelectric generator. The following are some patented projects that are similar to this study-

Research paper published by Prashanth k and Sonam wango on the designing of thermoelectric generator Setup to produce electricity in plenty. By using proper heat sink material help to increase the output voltage. Using long proper heat sink material is to avoid the heat in between the gap of fins. By addition of the more TEG in SERIES is to increase the voltage.

Albert Patrick J. David Proposed a research paper on how waste heat of home appliances as well as heat of human body can be retrieved in the form of electricity.

The use of larger thermoelectric generator to generate more energy Use commercially available DC to DC step up converter. Integration of larger Power Bank as energy storage for later use. Heat of Human body can be used to generate milliwatts of electricity. The prototype can be enhanced further for more efficiency and better results.

Z.B. Tang, Y.D. Deng, C.Q. SuW.W. Shuai, C.J. Xie proposed a research paper on the electrical performance of the TEG system under mismatch conditions, such as the limited working temperature and the inconsistent temperature distributions among the modules in series connection.

3. METHDODOLOGY

3.1 BLOCK DIAGRAM

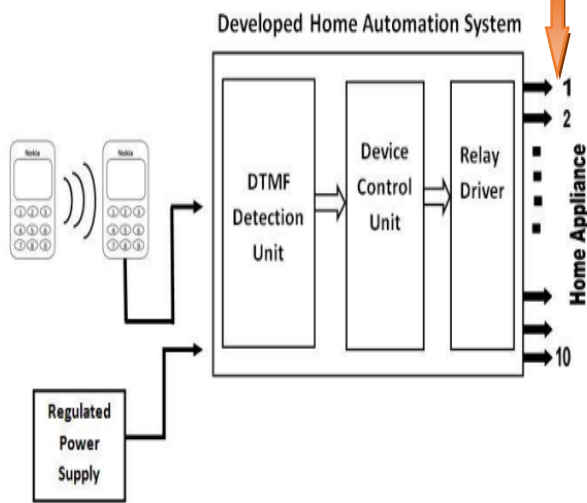
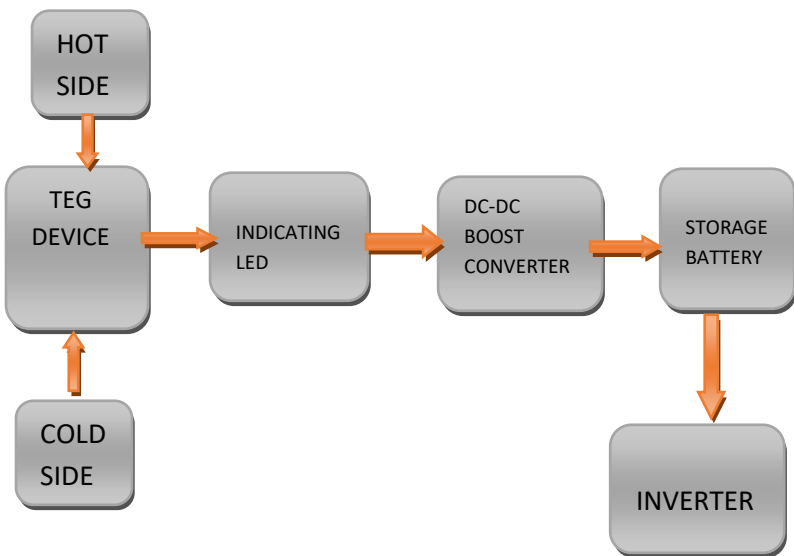

BLOCK DIAGRAM-1

3.2 PROJECT DEVELOPMENT

As shown in the block diagram waste heat is given to the TEG, Hot side maintained by the waste heat and cold side maintained by heat sink contains small fans. A DC-DC converter is connected to maintain output voltage at a certain level which is acceptable by battery. Then a small led light is connected as a load which gives information about that TEG generated output voltage. Now output voltage gave to the inverter circuit which is directly connected to the loads. A regulated power supply is given to the DTMF module and DTMF module is connected to the relay driver circuit through a device control unit and now load can be

controlled wirelessly by user's mobile using DTMF tones. This is how project works.

4. HARDWARE DESCRIPTION

4.1 THERMOELECTRIC GENERATOR MODULES

A TEG module (SP1848-27145) is used for electrical power generation where we need to apply temperature difference. A thermoelectric generator consists of a p-type and n-type semiconductors connected in series. It is a device which convert thermal energy to electrical energy by using an array of thermocouples.

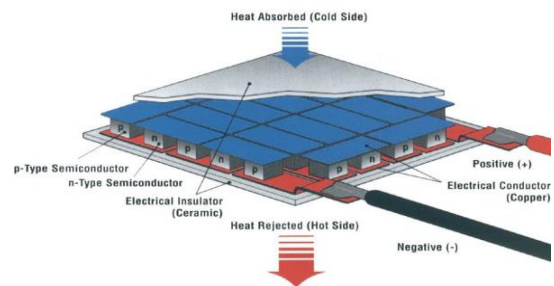
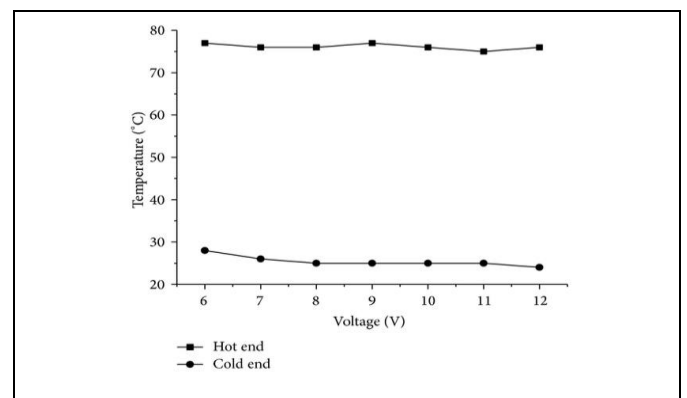

Fig-1: TEG MODULE

It works on a principle called seebeck effect. When heat is applied on the one side of TEG, the electrons in the n-type semiconductor and holes and the holes in the p-type semiconductor will move away from the heat source. This pair of n-type and p-type semiconductor forms a thermocouple. To increase voltage and current rating series and parallel connection can be used. In this project we have used eight TEG module in which four of them are in two sets of series connection and these two sets connected in parallel.



Graph-1(Temperature vs voltage graph)

Graph-1 shows how the output voltage changes with temperature. From the above analysis we can conclude that larger temperature difference produces high voltage. Rating of a TEG module is 2.6volt, 0.1ampere.

4.2 BATTERY (12Volt,2.5Ah)

A 12volt 2.5Ah dry battery is used to store the charge which we get from TEG module setup. As one module has a rating of 2.6volt so according to the connection Maximum 10.6 volt can be produced which is not sufficient to charge the battery, so a DC-DC boost converter is used to boost up the voltage.



Fig-2: DRY BATTERY

4.3 DC-DC BOOST CONVERTER(3v-32v_5v-35v)

DC-DC boost converter (XL6009) is used to boost up the voltage output given by TEG module setup. Now a 15-volt regulator is connected to limit the voltage and make the voltage accessible for battery to charge properly. A diode is also connected with voltage regulator for safety purpose (for unidirectional current flow).

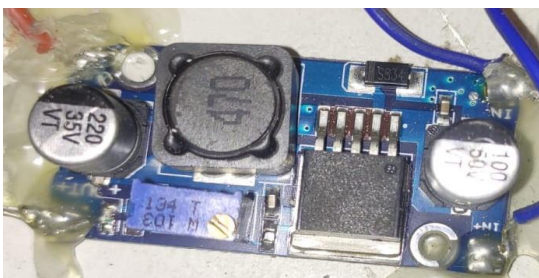

Fig-3: DC-DC BOOST CONVERTER

4.4 INVERTER CIRCUIT (12V DC-220V AC)

A 12volt DC - 220V AC, 80-Watt inverter circuit is used to convert dc battery voltage and current to ac voltage and current to make usable in DTMF controlled loads, loads are supplied by this inverter circuit.

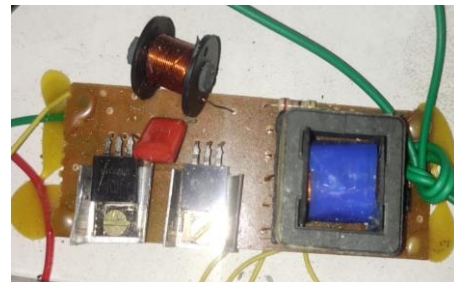

Fig-4: INVERTER CIRCUIT

4.5 DTMF MODULE (IC MT8870)

Dual Tone Multi Frequency (DTMF) Module is used to decode the input DTMF encoded signal which it gets from a mobile phone connected by auxiliary cable connected to DTMF module. MT8870 is a DTMF receiver integrating band split filter and digital decoder filter. The decoder uses digital counting techniques to detect and decode all 16 DTMF tone pairs into a 4-bit code.



Fig -5: DTMF MODULE

4.6 RELAY DRIVER CIRCUIT

Here four relays are used to connect low voltage electronics circuit to high voltage(220v,50hz) A.C. circuit. Relays are either energized and latched or deenergized and unlatched. Here opto-couplers (opto-isolators, PC817) are used as relay driver circuit, which takes DTMF decoded signal from DTMF decoder and passed it to relays. Relays will work on the command given by optocouplers and loads (connected to the relays) can be controlled by DTMF tones.



Fig-6: RELAY DRIVER CIRCUIT

Button	Low DTMF frequency (Hz)	High DTMF frequency (Hz)	Binary coded output			
			Q1	Q2	Q3	Q4
1	697	1209	0	0	0	1
2	697	1336	0	0	1	0
3	697	1477	0	0	1	1
4	770	1209	0	1	0	0
5	770	1336	0	1	0	1
6	770	1477	0	1	1	0
7	852	1209	0	1	1	1
8	852	1336	1	0	0	0
9	852	1477	1	0	0	1
0	941	1336	1	0	1	0
*	941	1209	1	0	1	1
#	941	1477	1	1	0	0

Fig-8: OUTPUT OF DTMF TONES

When the circuit is powered, decoder continuously checks the inputs. When '1' is pressed from mobile keypad, decoder IC decodes the tone and produces 1(0001), and load 1 will on. When 2 is pressed decoder IC decodes the tone and produces (0010), so only load 2 loads will on. According to this sequence there are 12 possible combinations to control the loads.

5. PROPOSED SYSTEM

First of all, a thermoelectric generator setup is designed using Peltier modules. For maintain the cooling side temperature heat sinks and two cooling fans are implemented.

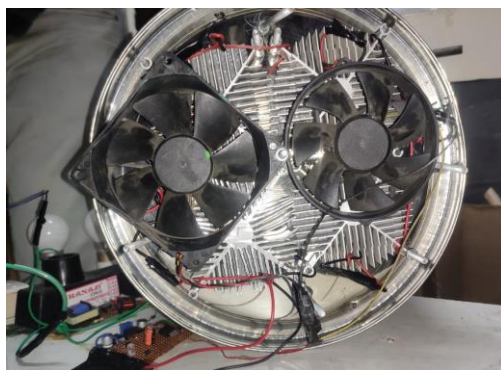

Fig-7: HEAT SINKS AND FANS

After that a home automation system is designed using DTMF module and 4 channel relay modules. Then combine both systems using appropriate electrical and electronics equipment's to make a hybrid automated power system. Output of thermoelectric generator will feed to a dc-to-dc boost converter which will step up the output voltage and then a 15-volt regulator is connected to get constant voltage output which is appropriate for storage battery. Then inverter circuit is connected to the battery to get AC output voltage which fed loads controlled by DTMF automation system. DTMF module will be energized with a 5v supply. A mobile phone is connected with the DTMF module with the help of auxiliary cable. Mobile phone is on auto-receive mode. When user call at that mobile phone then it will receive automatically and by dialing different number keys user can control different loads. Loads will control according to this table



Fig-9: HARDWARE IMPLEMENTATION

6. ADVANTAGES

- Clean, noiseless, green energy, no fossil fuel is required, portable.
- Promising technology for solving power crisis problem
- Pollution free.

7. FUTURE SCOPE

Even body heat also generates the heat that can be utilizing by using TEG to generate the power to charge the portable equipment like laptop, mobile. By using thermoelectric generators, we can generate electric power for home appliances.

8. CONCLUSION

Consider the increasing demand of electricity, need of electricity in remote areas and need of automation a HOME AUTOMATED POWER SYSTEM is proposed.

In village areas earth stoves are used if this proposed system replaced earth stoves, then problem of electricity can be somehow decrease. It is also considered that studies and researches are made constantly to increase the efficiency and the requirement for reducing emission of gases that causing global warming. Now it is possible to get free electricity from stuffs from our home. The prototype can be enhanced further for better efficiency and better results.

Resent method for electricity generation is converting thermal energy into mechanical energy by turbine then into electricity by using generator. Burning of these fuels causes environmental problem like radio activity pollution, global warming. Hence (coal, oil, gas) are the limiting resources resulting new technology is needed. The project paper is tested and implemented. The system gives the best economical pollution free, required energy solution to the people.

ACKNOWLEDGEMENT

I wish to extent my special thanks to Dr. Sandeep Goyat (Assistant Professor, Greater Noida Institute of Technology)

REFERENCES

- [1] The World Bank Figure (June 7 2021)
- [2] Albert Patrick J. David, Faculty of Information and Communications Department Bulacan State University (Meneses Campus) Malolos City, Philippines
- [3] D. Flahaut, T. Mihara and R. Funahashi, N. Nabeshima, K. Lee, H. Ohta and K. Koumoto, JOURNAL PHYSICS 100, 0=184911 (2006)
- [4] Z.B. Tang, Y.D. Deng, C.Q. SuW.W. Shuai, C.J. Xie. a Hubei Key Laboratory of Advanced Technology for Automotive Components, Automobile Engineering Institute, Wuhan University of Technology, china.
- [5] haut, T. Mihara and R. Funahashi, N. Nabeshima, K. Lee, H. Ohta and K. Koumoto, JOURNAL PHYSICS 100, World bank, world development indicators.
- [6] PRASHANTHAK, SONAM WANGO, Electrical engineering Department, BCET, INDIA, Bangalore College of Engineering and Technology, International Journal of Mechanical and Production Engineering, ISSN: 2320-2092

BIOGRAPHIES



The author is currently doing his bachelor's degree in department of electrical engineering in Greater Noida Institute of technology under DR APJ Abdul Kalam technical university.



The author is currently doing his bachelor's degree in department of electrical engineering in Greater Noida Institute of technology under DR APJ Abdul Kalam technical university.



The author is currently doing his bachelor's degree in department of electrical engineering in Greater Noida Institute of technology under DR APJ Abdul Kalam technical university



The author is currently doing his bachelor's degree in department of electrical engineering in Greater Noida Institute of technology under DR APJ Abdul Kalam technical university.



The author is currently working as Assistant Professor in the department of Electrical Engineering in Greater Noida Institute of Technology.



The Author is currently working as Head of Department in Electrical Engineering in GNIOT.