

Simulation of Disc Brake Rotor and Pad Using ANSYS Workbench

Noha Muhammad Abd ElSalam¹, Prof Ibrahim Ahmed², Sameh Metwally³, Mostafa Mohamed⁴,
Ahmed Abdallah Hussien⁵, Essam Morsy⁶

¹Researcher, Automotive and Tractors Engineering Department, Faculty of Engineering, Helwan University, Egypt

²Professor at Automotive Engineering Department, Helwan University, Egypt

³Professor at Automotive Engineering Department, Helwan University, Egypt

⁴Doctor at Automotive Engineering Department, Helwan University, Egypt

⁵Automotive Department, Helwan University, Egypt

⁶Professor at Automotive Engineering Department, Helwan University, Egypt

Abstract - This paper discusses how to achieve selected modal to more related studies disk brake rotor such as structural, transient structural, explicit dynamic and thermal simulation. 3D model established by Solidworks is imported into ANSYS Workbench, and modal simulation analyses are carried out. It also presents a study of the different modal of the automobile disc brake phase. Then, study of pad modal between the disc and pads is developed, simulation analyses are carried out. Using the maximum stress point and maximum deformation position under the emergency braking state, combined with the results of modal analysis cloud chart, the resonance range is verified by comparing with the natural frequency, which provides reference for the actual tests and structural improvement.

Key Words: Disc brake, SolidWorks, ANSYS, Cast Iron, Steelformating.

1. INTRODUCTION

Brakes are mechanical device for increasing the frictional resistance that retards or stops the turning motion of the vehicle wheels. It absorbs kinetic energy and transforms it to heat. The brakes must be capable of decelerating the vehicle at faster rate than the engine is able to accelerate it. Brake performance is improved by increasing friction, so the friction coefficient plays an important role in the braking process [1]. The pedal force, which is generated as a result of the driver desire, is the input and the brake or friction force is as the output. The hydraulic force is converted to the brake force with an amplification factor called the characteristic brake factor [2]. When the driver steps on the brake pedal, hydraulic fluid is pushed against the piston of the caliper, which in turn forces the brake pads into contact with the rotor. The frictional forces at the sliding interfaces between the pads and the rotor retard the rotational movement of the rotor and the

axle on which it is mounted. The kinetic energy of the vehicle is transformed into heat which is mainly absorbed by the rotor and the brake pad. To ensure robust brake performance some brake systems require the pads to frequently be in low pressure contact with the rotor. This dragging removes any oxide layer (e.g. rust) from the rotor and keeps the contact surfaces clean. However, the resulting drag torque is a drawback as it increases fuel consumption. Therefore the dragging should be reduced without affecting the performance of the brakes. It is important to be able to predict the pressure and time needed to wear off the unwanted oxide layers [3]. This paper discusses how this can be done using general purpose finite element software. A three dimensional finite element model of the pad and rotor is designed to calculate the pad-to-rotor pressure distribution. A wear simulation process based on a generalized form of Archard's wear law and the Euler integration scheme is used to simulate the wear of both surfaces of the contact pair. The problems of disc brake are the noise, vibration and corrosion.

The main components of a Disc brake are:

- Brake pads
- Calipers, containing piston
- Disc brake rotor

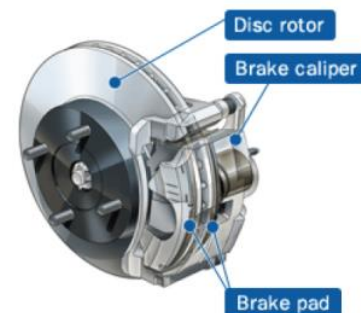


Fig. 1: Disc brake and components.

2. OBJECTIVE

The main objective of this work understands the work of brake system, mechanics, structural rigidity and low stress materials to design a new model and optimize this design. A disc brake is designed by using Solidworks and also is carried out by using finite element analysis (FEA). Thus the values of shear stress, total deformation and distribution on disc brake are obtained.

- Finite element models study of the disc and the pad which display acceptable correlation with the available results.
- Study the natural frequency of the pad and rotor disc.
- Study the contact pressure distribution at the pad and rotor disc interface under normal sliding conditions at one and two piston pressure.
- Suggest realistic and coherent strategies for eliminating squeal at the design stage using the results of the above studies.
- Compare results.

3. NATURAL FREQUENCY OF PAD / DISC

The frequency of Disc brakes braking noise is mainly distributed in 10~16000 Hz [4], which can be divided into low-frequency vibration noise (10~1000Hz), high-frequency vibration noise (>1000 Hz) which can be further divided into Low-far Squeal (1000~3000 Hz) and High-far Squeal (>3000 Hz).

4. PRESSURE ANALYSIS OF THE DISC BRAKE AND STUDY OF CONTACT BRAKE PAD / DISC

The disc brake assembly used in this study consists of three major components, the caliper, the disc and the pads. The caliper interacts with the inner pad via the piston and with the outer pad via the paw. Both pads are prevented from circumferential motion by the abutments which can operate either on the leading or trailing edge of the pad or on both. The contact at these external connections is modeled as stiff springs thus avoiding the need to include a caliper model in the stability analysis. The most active interactions occur between the pads and the disc and the pad-disc interface is of utmost importance because this is where the circumferential friction force excites the transverse motion of the disc and the pads. Therefore it is necessary to determine the contact area and pressure distribution between the pads and disc for various conditions in order to provide the information for

calculation of the contact stiffness magnitude and distribution for the subsequent stability analysis.

Theory of disc brake

Frictional brakes: Friction brakes are the most commonly employed braking system in commercial or special purpose vehicles. They generally are rotating devices with a rotating wear surface like Disc and a stationary pad. Here, the kinetic energy of the moving vehicle is utilized to stop the vehicle by conversion of this kinetic energy into heat energy/frictional energy [5]. A few common configurations of this type of braking are disc brakes, drum brakes and hydrodynamic brakes.

Disc brakes: Shoes or pads contract and provide compressive frictional force on the outer surface of a rotating Disc. It is a circular metal Disc on which the pads are mounted. Usually it is made up of cast iron material. The design of Disc brakes is varied depending on the application, amount of exposure, thermal properties of the material and the amount of heat dissipation required when brakes are applied and the total mass to be stopped [6].

Design model

Dimensions are taken from actual disc brake, to obtain a 3D model of the disc brake rotor. Used SolidWorks Programs to build and design model. Figure 2 shows model of disc brake

Finite element analysis

The finite element method is a powerful tool to obtain the numerical solution of wide range of engineering problems. This method is generally sufficient to handle any complex shapes or geometries, for any material under different boundary and loading conditions. The generality of the finite element method fits the analysis requirement of present days

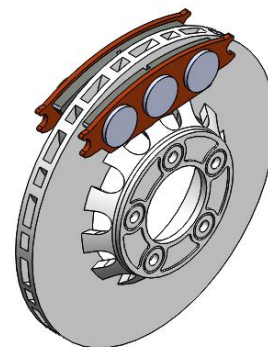


Fig. 2: 3D model

complex engineering systems and designs where solutions of governing equilibrium equations are usually not available. In addition, it is an efficient design tool for designers can perform parametric design studies by considering various design cases, (different shapes, materials, loads, etc.). And analyze them to choose the optimum design.

FEM in the automotive industry is a tool to study stress in a complex structures. The matrix analysis method used in automotive design has gained increased popularity among both researchers and practitioners. The basic concept of finite element method is that a body or structure is divided into small elements of finite dimensions called "finite elements" through generation of meshes. The original body or the structure is then considered as an assemblage of these elements connected at a finite number of joints called nodes or nodal points. This analysis employs the technique of vibrations and calculus to produce accurate results.

The system modal analysis processes are as follows. System vibration differential equation:

$$m\{\ddot{x}\} + c\{\dot{x}\} + k\{x\} = f(t) \tag{1}$$

$$m\{\ddot{x}\} + k\{x\} = \{0\} \tag{2}$$

$$\{x\} = \{\varphi_i\} \cos \omega_i t \tag{3}$$

$$[k]\{\varphi_i\} = \omega^2 [m]\{\varphi_i\} \tag{4}$$

$$|[k] - \omega_i^2 [m]| = 0 \tag{5}$$

m, c and k represent mass, damping and stiffness matrix respectively; $f(t)$ represents the load function changed with time; \ddot{x} represents the node acceleration vector; \dot{x} represents the node velocity vector; and x represents the node displacement.

The natural vibration frequency ω_i of the i order and the eigenvector φ_i corresponding to the i modal shape of the system can be calculated through the above equation.

The transient dynamic structural analysis performed with the ANSYS program determines the structure's response to tasks that vary arbitrarily (randomly) over time. In a transient dynamic analysis equation of motion is:

$$[M]\{\ddot{u}\} + [C]\{\dot{u}\} + [K]\{u\} = \{f(t)\} \tag{6}$$

$$[C^T]\{\dot{T}\} + [K^T]\{T\} = \{Q(t)\} \tag{7}$$

Where, $[M]$ is mass matrix, $[C]$ is damping matrix, $[K]$ is stiffness matrix, $\{\ddot{u}\}$ is nodal acceleration vector, $\{\dot{u}\}$ is nodal velocity vector, $\{u\}$ is nodal displacement vector and $\{f(t)\}$ is load vector. At any given time t .

5. FEM USING ANSYS

Simulation of the problem ANSYS

The finite elements ANSYS Workbench is used in this section to simulate the behavior of the mechanism of frictional contact of two bodies (pad and disc) during a stop braking. This code has algorithms of management of the contact with friction based on the method of Lagrange multipliers, or the penalty method. The disc brake product typically includes the following steps:

- Build the model in the SolidWorks.
- Imported 3D model to ANSYS Workbench.
- Evaluate the results of the tests.

Modal analysis of brake pad

Modal analysis is a way of calculating equations by means of coordinate transformation, which mainly includes four kinds of dynamic characteristic analysis. The definition is to use the physical coordinates in the vibration differential equation of the linear constant system to be converted into modal coordinates to solve the equations and obtain a set of independent equations described by modal coordinates and modal parameters. It is a common method in today's research on the dynamic characteristics of structures. The analysis process and results are obtained by the method of finite element calculation, which is called computational modal analysis.

Meshing

Due to the special structure of the disc brake and pad, there are many grooves and chamfers. In order to ensure the quality of meshing and calculation accuracy, some simplifications are made when importing the 3D model. The unit type used for meshing is solid 186, and the unit is selected (mm, t, N, s, mv, mA). The final result is shown in the table 1 and 2.

Table 1 Modal analysis difference related to different mesh densities for disc rotor.

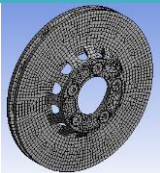
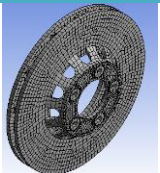
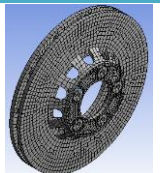
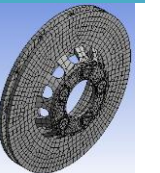
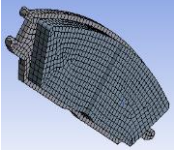
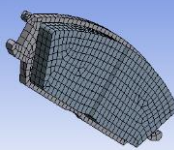
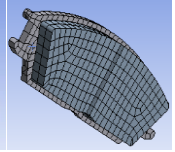
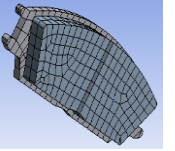
Natural frequency (Hz) for the following			
			
Mesh 19933 elements	Mesh 15016 elements	Mesh 13142 elements	Mesh 9383 elements

Table 2 Modal analysis difference related to different mesh densities for pad.

Natural frequency (Hz) for the following			
			
Mesh 7099 elements	Mesh 4735 elements	Mesh 3736 elements	Mesh 3573 elements

Setting the material parameters in the material property module selected the structural steel 1006 and iron steel material that has been set. The main physical property parameters of this material are shown in the table 3.

Table 3: Mechanical characteristic of brake parts

Properties	Disc	Pad
Density (kg/m^3)	7850	2800
Young's Modulus (Pa)	2E+11	2.2E+9
Poison's Ratio	0.3	0.25

Load and restraint determination

Defining constraints, apply full constraints on the center holes surface of the brake disc,

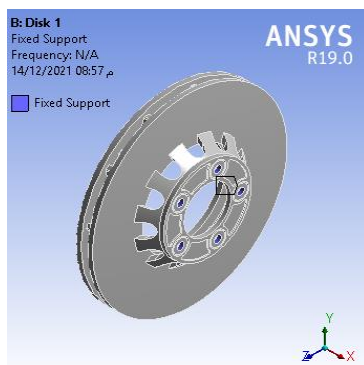


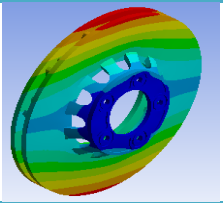
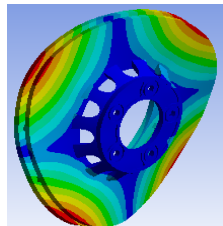
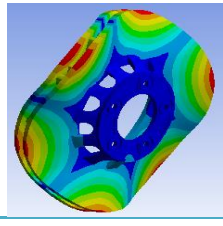
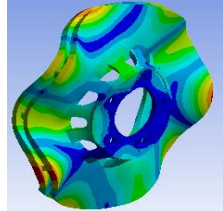
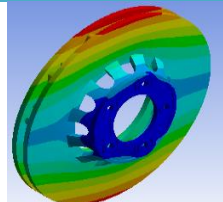
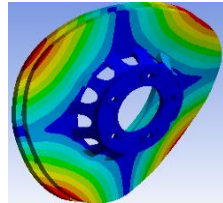
Fig 3. Constraint position

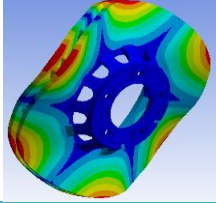
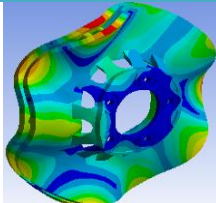
6. Modal analysis process and results

The modal analysis is executed in the modal analysis module of ANSYS Workbench software. The geometric model of the brake disc and pad are imported. The material properties are set and the brake disc and pad are meshed. The modal analyses results of the brake disc and pad are finally obtained. When analyzing the modal results, select 1,5,10 and 20 frequencies values

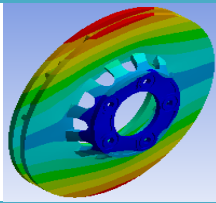
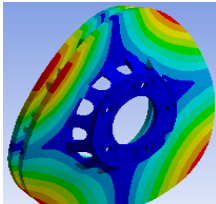
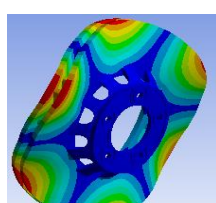
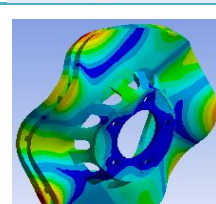
and mode description of the brake disc and pad as shown in table 4.

Table 4 Comparison between the simulated results and values for the model of disk rotor.

Case 1		
Mode	FEA value (Hz)	Mode shape
1	750.18	
5	1636.5	
10	3060	
20	5733.8	
Case 2		
Mode	FEA value (Hz)	Mode shape
1	761.38	
5	1645.1	

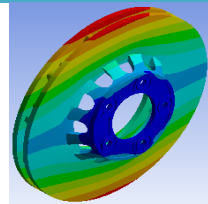
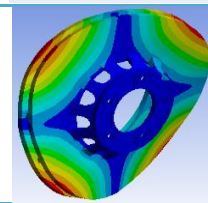
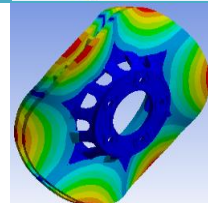
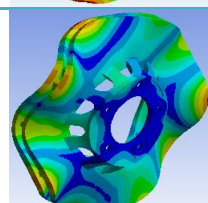
10	3076.6	
20	5770.8	

Case 3

Mode	FEA value (Hz)	Mode shape
1	760.13	
5	1644.3	
10	3073.5	
20	5767.2	

Case 4

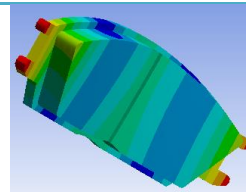
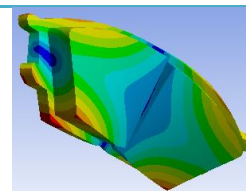
Mode	FEA value (Hz)	Mode shape
------	----------------	------------

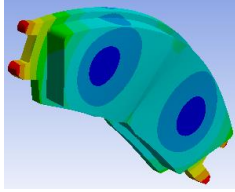
1	763.74	
5	1651.3	
10	3099	
20	5823	

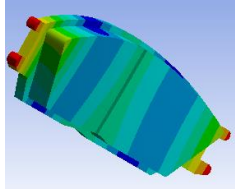
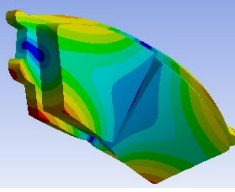
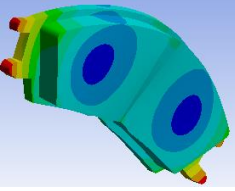
From the above, the lowest order frequency and the first order frequency of the brake disc are about 750.18Hz, 761.38Hz, 760.13Hz and 763.74Hz. Due to different brake structure, the modal analysis result shows the first and five-order modal frequencies are closer to the squeal frequency.

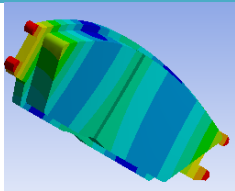
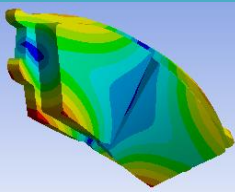
Table 5 Comparison between the simulated results and values for the model for pad.

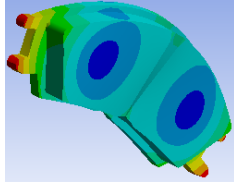
Case 1

Mode	FEA value (Hz)	Mode shape
1	4190.3	
2	9587.4	

4	12465	
---	-------	---

Case 2 Mode	FEA value (Hz)	Mode shape
1	4180.3	
2	9556.7	
4	12439	

Case 3 Mode	FEA value (Hz)	Mode shape
1	4204.9	
2	9592.4	

4	12453	
---	-------	---

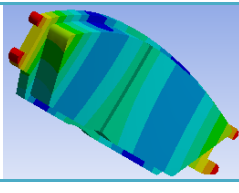
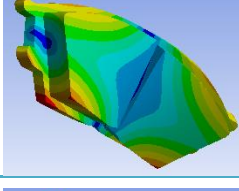
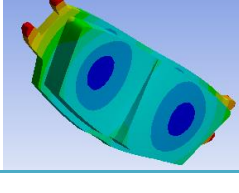
Case 4 Mode	FEA value (Hz)	Mode shape
1	4229.2	
2	9620.9	
4	12480	

Table 5 shows the natural frequency of the pads at 1, 2 and 4 modes. The order frequencies of the pads are shown in the table 4. Due to different pad structure and materials, the modal analysis result shows the first and four-order modal frequencies are closer to the squeal frequency.

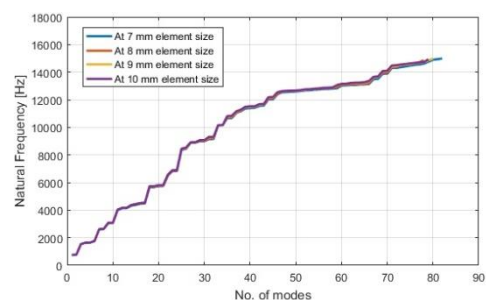


Fig. 4. Frequency for the disc rotor.

Figure 4 shows relation between four cases at different element size for disk brake rotor.

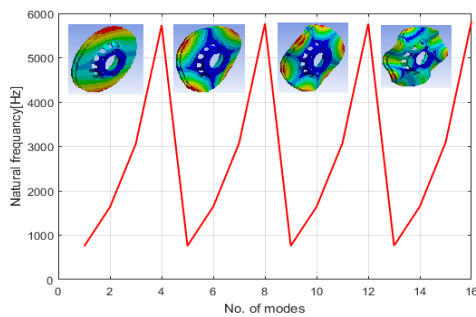


Fig. 5. Frequency Response Functions for the disc rotor.

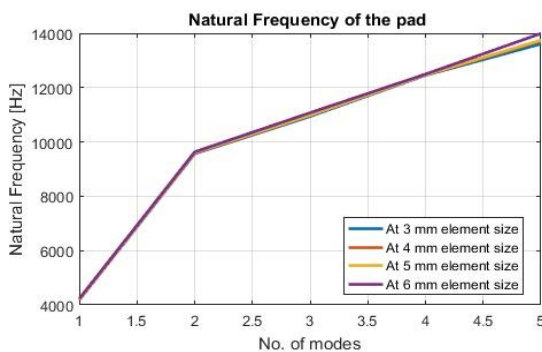


Fig. 6. Frequency for the pad.

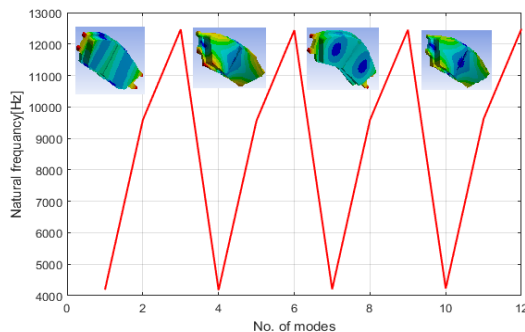


Fig. 7. Frequency Response Functions for the disc rotor.

7. CONCLUSION

This research uses the finite element method to perform modal simulation analysis on the disc brake rotor and pad of the automotive. The rotor disc is presented in the interval of 500-15000 Hz results for different mode shapes and analyzed. The results are compared. It is concluded that the rigidity requirements are met in the static analysis, but the brake squeal is prone to phenomenon. In the follow-up analysis, the occurrence of brake squeal can be reduced from the aspect of structural optimization. There are methods for reducing disc brake squeal through structural modifications. So several modifications are suggested

for the disc and pad including geometrical and material modifications.

References

- [1] Giri, N.K. "Automobile Mechanics" Romesh Chandra Khanna for Khanna Publishers, 2007.
- [2] Leber, M., Karheinz, B., Dusil, V. "Selbstversträkende Reibungsbremse" Patent, DE 195 39 012 A1, 1998.
- [3] A Söderberg, U Sellgren, S Andersson. "Using finite element analysis to predict the brake pressure needed for effective rotor cleaning in disc brakes".
- [4] Cao, Q., Ouyang, H., Friswell, M.I. (2004) Linear eigenvalue analysis of the disc-brake squeal problem. *Int. J. Nuwer. Meth. Eng.*, 61: 1546–1563.
- [5] Deaton JP (2008) How brake rotors work? Part-2. Retrieved from <http://auto.howstuffworks.com/auto-parts/brakes/brake-parts/brake-rotors2.html>.
- [6] How to build brake pads factory? One-stop solution by bull brakes! Volume5: Transport, Retrieved from: http://www.infovisual.info/05/013_en.html.