

# DESIGN AND ANALYSIS OF LIGHT WEIGHTED FOLDABLE SKATEBOARD

KEERTHI KUMAR.G<sup>1</sup>, KULANDAIVEL.D<sup>2</sup>

<sup>1</sup>PG Scholar, Department of Engineering Design, Government College of Technology, Coimbatore.

<sup>2</sup>Assistant Professor, Department of Mechanical Engineering, Government College of Technology, Coimbatore.

\*\*\*

**Abstract** -The main goal of this project is to find ways to reduce weight and cost in the design and manufacture of

lightweight, fold-able skateboards. The design aims to minimize the portability, comfort and space of the skateboard. The efficiency of the space requirement leads to the design of fold-able skateboards. Light and fold-able skateboards are made of natural composites (bamboo and wheat fibers) and are designed to fit in a backpack. Choose hybrid composites for advanced conceptual composites. Due to their high strength and light weight Synthetic fiber composites are popular, but the energy required for fiber extraction is very high, non-degradable and cost high. Due to these shortcomings, it is necessary to develop biodegradable and inexpensive composite materials. We will design a fold-able skateboard that will lighten the skateboard to adjust its size.

**Key Words:** skateboard, fold-able, jute fiber, natural composite, ANSYS, CREO

## 1. INTRODUCTION

As we know, people in Western countries use skateboards as their vehicle to take them short distances. Regular skateboards are very long and difficult to park and hold anywhere. In addition, regular skateboards are a bit difficult to carry. Our project overcomes these shortcomings of skateboarding. Students who choose to skateboard in class every day face the inconvenience and uncertainty of putting the board out of the classroom. This can pose a risk of theft and fire. We came up with the idea of developing a fold-able skateboard that fits in a backpack, and mostly we are reducing the weight of the skateboard. This design is based on the idea that the skateboarder evenly distributes the weight between the front and back halves of the board. This allows you to remove the central part of the board to reduce both size and weight. This design is intended to ultimately result in a lighter, stronger and more comfortable board that can be compressed in size for storage in a book bag or carried with one hand.

## 2. MATERIAL TESTING

### 2.1 Tensile testing

Tensile testing, additionally referred to as tensile testing, is a primary fabric technology take a look at that exposes pattern to managed tensile till it breaks.. The test results are used often for materials selection for applications,

quality control, and predict how materials react to other types of forces. The properties measured directly by the tensile test are tensile strength, maximum elongation, and area reduction. The sample was created according to ASTM D 638. Tensile tests are performed on UTM manufactured by INSTRON in the United States and have the maximum operating range 100 Kn, accuracy: plus or minus 0.66% strain curve of tensile stress-mean value

- Young modulus= 2.24GPa,
- Elongation= 1.35
- Ultimate stress = 56MPa

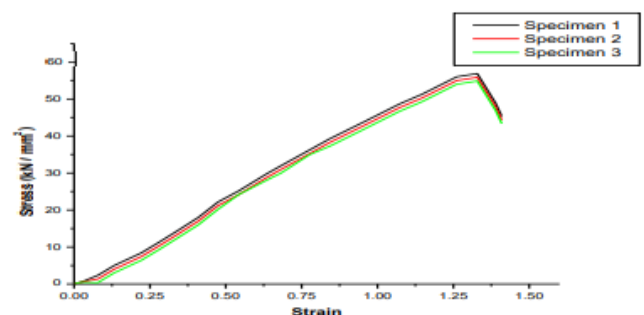

CHART-1 STRESS VS STRAIN

### 2.2 Impact Test

The Izod take a look at is achieved to evaluate the effect energy of plastics. It is a fashionable for plastics, however it's also used for different materials. The Izod take a look at is maximum generally used to evaluate the relative longevity or effect resistance of a material, so the is extensively utilized in exceptional manipulate applications, that is a quick and cheaper take a look at. This is used as a benchmark take a look at, now no longer a definitive take a look at. This is in part because of the truth that the values aren't precisely associated with the effect energy of the molded component or real thing beneath-neath real working conditions the pendulum is attached to the roller bearing. There are two starting positions, the upper one is for Charpy and the lower one is for Izod test. When the pendulum is released, the pendulum swings downward and destroys the test piece, and the absorbed energy is measured as the difference between the drop height before the destruction and the lift height after the test piece is demolished. Izod tests are performed according to ASTM D256 to obtain impact

strength. The test was carried out on an Izod & Charpy impact tester with a notch cutter manufactured by Tinius Olsen, USA, with an accuracy of  $\pm 0.0015$  joules. The average impact strength of this composite is  $28.5 \text{ kJ} / \text{m}^2$ .

### 2.3 Hardness Testing

The hardness check is finished on a virtual hardness tester geared up with a version RBHT, M scale, a 100 kgf load capacity, and a 1/4 inch ball penetrator. The hardness value of the M scale of the hybrid composite material is 62.5 (average value). ) And above the hardness value of the natural fiber hybrid composite material.

### 2.4 water absorption test

Hybrid composites are machined to the required dimensions after manufacture according to ASTM Standard D5229. In three different media Moisture absorption tests were conducted: seawater, purified water, and well water. This different water was taken in the same proportions in different cups. Seawater and borehole water are obtained from the supplier and the known weight of the composite sample is soaked in different waters for a period of time and the absorbed moisture is recorded by weighing the sample. Sample of moisture absorption test under water and weighing machine, minimum number is 0.01g. The water absorption test is conducted for 48 hours at room temperature of  $22^\circ \text{C}$  and humidity of 55%. Figure 19 shows a diagram of the water absorption rate over time.

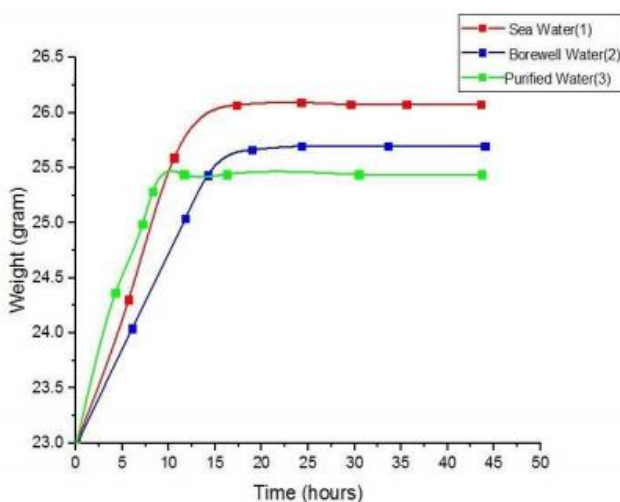

CHART-2 WEIGHT VS TIME

## 3. BAMBOO TREATMENT

The hydrophilicity of bamboo strands is because of artificial elements along with lignin, which could lessen binding to hydrophobic framework materials. Many scientists have followed a formulation, alkalization, bond copolymerization, and adhesion operator-primarily based

totally approach with precise endpoints for bamboo delignin.

### 3.1 Alkaline treatment

The maximum not unusualplace chemical remedy of herbal fibers is alkaline remedy withinside the manufacturing of thermoplastics and thermosetting resins. Excess lignin, wax and oil at the outer floor of the fiber mobileular are eliminated with the aid of using alkaline remedy. Ionization of the hydroxyl organization need to be carried out with the aid of using NaOH remedy. Alkaline remedy of fibers has effects. On the one hand, the roughness of the outer surface can be increased, thereby the mechanical interlock is increased, and on the other hand, the amount of cellulose on the fiber surface can be improved.

### 3.2 Silane Treatment

Silane remedy takes place maximum prominently withinside the presence of water and also can lessen the wide variety of cellulosic hydroxyl businesses. The mixture of water and hydrolyzable alkoxy businesses bureaucracy silanol, which reacts with the hydroxyl businesses of the fibers to shape covalent bonds with the walls.

### 3.3 Acetylation of Natural Fibres

The hygroscopicity of herbal fibers is measured after acetylation. Reduced creation of acetyl useful organizations into compounds. Sisal fibers are regularly handled with an acetylation remedy to growth the adhesion of the fiber matrix.

### 3.4 Benzoylation Treatment

The benefit of this remedy is that the presence of benzoyl in benzoyl chloride reduces the hydrophilicity of the fibers and extensively improves the interplay with matrix for adhesion. It additionally reduces the water absorption rate.

### 3.5 Permanganate Treatment

Potassium permanganate is an answer by and large used to deal with permanganate. The gain of permanganate remedy is that it reduces the hydrophilicity of the fibers and improves the adhesion among the fibers and the matrix.

### 3.6 Peroxide and Isocyanate Treatment

Compounds inclusive of benzoyl peroxide and dicumyl peroxide are used to regulate herbal fibers. In this form of remedy, after pretreatment with alkali, the fibers are covered with an outer coating of BP or DCP in an acetone solution. This remedy can boom the tensile power of the fiber.

#### 4. RESULT AND DISCUSSION

A regular stress-pressure diagram is proven in Figure 1 . The voltage will increase with growing load and reaches its maximum. At this point, a big voltage drop is determined because of the tensile failure of the outermost piece of bamboo. Stress-strain curve variation after peak stress due to continuous fracture of bamboo

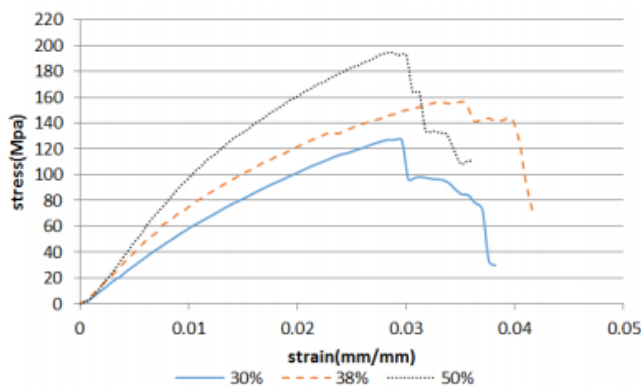

Chart -3 stress vs strain

Note that increasing the volume of bamboo also increases its bending strength and modulus. Initially, the stress-strain curve is straight, but as the load increases, its gradient decreases, so the flexural modulus is calculated using the first part of the curve. Table 1 shows the bending test results.

Table -1:

	Specimen number	Maximum flexural stress (mpa)	Experimental flexural modulus (mpa)
30	1	127	6070
	2	142.40	5866
40	1	158	8365
	2	190	7350
50	1	160.20	9220
	2	195.30	10410

#### 5. FINITE ELEMENT ANALYSIS

We simulated the bending test of the bamboo composite test piece with Hyper-mesh and confirmed that the same result as the experiment was obtained. This analysis considered a bamboo composite with a fiber volume of 50%. In Table 4 The elastic constants are shown . The sample was only supported between two points and was limited to moving in Z axis. The distance between the supports is 65 mm. In center 220 N of a point load acts .

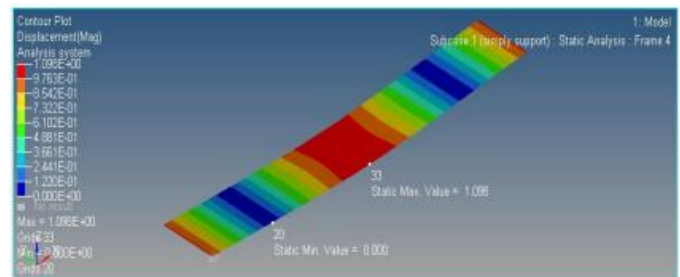

Fig -1 Displacement in flexure specimen

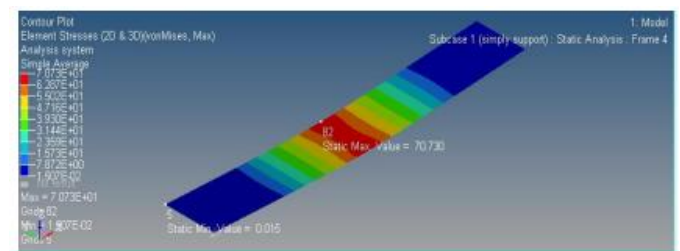

Fig -2 Stress in flexure specimen

#### 6. FEA RESULT

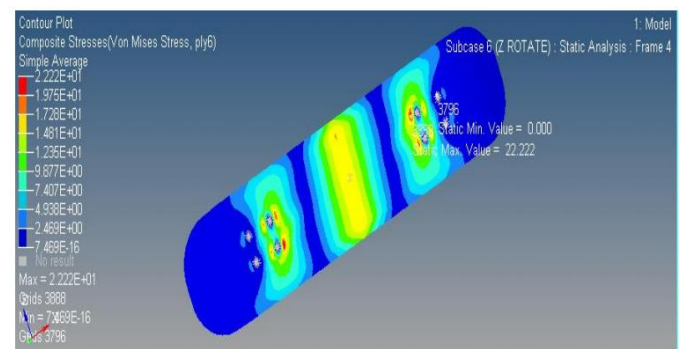

Fig-3 composite stress z rotation

This is the outermost layer of the laminate, wherein the stiffness of the layer is maximum alongside the x direction (00), so the best anxiety is observed with inside the layer of fibers alongside the x axis (00).

#### 7. MODEL USING CATIA

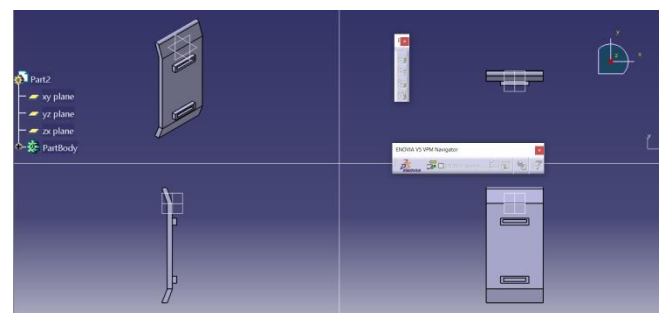
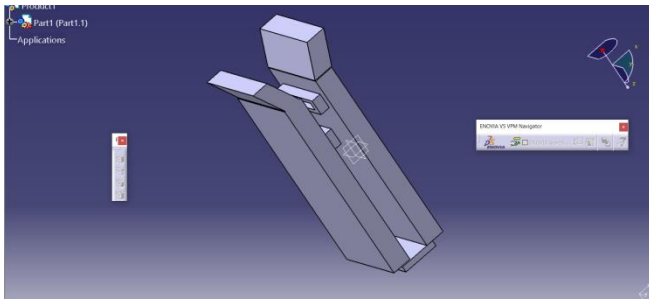

Fig -4 skateboard normal



**Fig -5** skateboard fold-able

[9] Meenambika.G and Raghavendra H, Mechanical and Chemical properties of Bamboo/Glass fibers reinforced polyester hybrid composites, IISTE.Vol4, 2014, pg39-42

## 8. CONCLUSION

The project ended with the design of a foldable skateboard that fits in a backpack. Various types of tests, processes, and extraction methods are performed to select the required composite material, and analysis is performed in ANSYS. As you can see, you need a longboard skateboard that can be folded and folded for easy storage and transportation when not in use.

## REFERENCES

- [1] S.S. Suhaily, H.P.S.A. Khalil, W.O.W. Nadirah, Jawed, Bamboo Based Bio composites. Mater. Des. Appl., 492.
- [2] H.P.S. Abdul Khalil, I.U.H. Bhat, M. Jawaid, A. Zaidon, D. Hermawan, Y.S. Hadi . Bamboo fibre reinforced bio-composites: A review. Materials and Design 42 (2012) 353– 368
- [3] Shah Huda, Narendra Reddy. Ultra-light-weight composites from bamboo strip and polypropylene web with exceptional flexural properties. Composites: Part B 43 (2012) 1658–1664
- [4] C.S. Verma, V.M. Chariar. Stiffness and strength analysis of four layered laminate bamboo composite at macroscopic scale. Composites: Part B 2012Y.
- [5] Xiao, J. Ma, Fire Simulation Test and Analysis of Laminated Bamboo Frame Building, Constr. Build. Mater. 34 (2012) 257–266.
- [6] C.S. Verma, V.M. Chariar, R. purohit .Macro mechanical analysis of bamboo lamina. IJCPT IS SN 2277-4808 Vol.2 june 2012
- [7] Shah Huda, Narendra Reddy. Ultra-light-weight composites from bamboo strip and polypropylene web with exceptional flexural properties. Composites: Part B 43 (2012) 1658–1664
- [8] Kazuya Okubo, Toru Fujii, Yuzo Yamamoto. Development of bamboo based polymer composites and their mechanical properties. Composites: Part A 35 (2004) 377–383