

# An Overview of Batteries used for Electric Two-Wheelers in Indian Drive Cycle

Navaneeth M<sup>1</sup>, Jithin J<sup>2</sup>, Anitha KR<sup>3</sup>, Swathi PV<sup>4</sup>, Advait Uday<sup>5</sup>

<sup>1,2,3,4</sup>B.Tech student, Dept. of Electrical and Electronics, TKM college of Engineering, Kerala, India

<sup>5</sup>B.Tech student, Dept. of Electrical and Electronics, College of Engineering Trivandrum, Kerala, India

\*\*\*

**Abstract** -The field of mobility is undergoing a deviation from conventional Internal Combustion Engine (ICE) vehicles to Electric Vehicles (EVs). From the beginning of the 19th Century Electric Vehicles faced few major disadvantages when compared to ICE vehicles like shorter range, higher sticker price and longer refueling time. Various chemistries of batteries were used since the beginning of the 19th century. This paper provides an overview of various types of batteries used in Electric Vehicles and showcases the advantages that the Solid-State Batteries provides over the other chemistries of batteries, specifically Lithium-Ion Batteries which have liquid electrolyte. In this paper a conventional ICE bike was retrofitted to an E-Bike and the best battery in drive cycles in India was found. Various parameters like energy density, power density, safety, cost, cycle life, etc. were compared and showcased why Lithium based SSBs are promising for use in EV applications.

**Key Words:** Electric Vehicles, Lead Acid battery, Nickel Metal Hydride Battery, Lithium-Ion battery, Solid State Battery, Drive cycle.

## 1. INTRODUCTION

The greatest invention of mankind is the wheel. It preceded the way for the future of transportation. The First EV was introduced way back in 1834 around the 1870s electric vehicles came into the market [1]. The lack of good batteries and less range were the main drawbacks of EVs at that time. Low-cost petroleum and electric starters caused the development of ICE vehicles [2]. The mass production of Ford model T played an important role in decreasing the price of IC engine vehicles [3]. This further kept the consumers away from EVs and the industry began to fade away from the market. Since then, IC engines were the best option and the vehicle industry evolved a lot.

Around the late 20<sup>th</sup> century, the world witnessed a massive hike in pollution level and realized the effects of global climate changes, the need for clean energy became the need of the hour and it triggered the search for a better alternative [4]. The European new vehicle CO<sub>2</sub> regulation (which prescribes a mandatory value of 95 grams of CO<sub>2</sub> per kilometre by 2021 for passenger cars) is currently in the process of being extended to 2025 [5]. EVs are also proven to reduce carbon emission, so the need of

electric propulsion in vehicles became a necessity [6]. Even though several manufacturers started producing EVs, it was Tesla's roadster that made them popular [7]. Of all the factors, battery is the crucial part of an EV, it determines the range of the vehicle, cost, safety and overall performance of the vehicle to a great extent.

The development in the EV industry directly depends on the battery capacity it can use. For low cost to energy ratio, lead acid batteries are preferred for an electric vehicle. But these batteries have low cycle life compared to other batteries [8]. Further, lead acid batteries are bulky and heavy to use in an electric vehicle, thus affecting the range of the vehicle. So, these disadvantages were overcome by the Nickel Cadmium battery. They were much lighter, economical and space efficient. It also offered a good power to weight ratio [9]. Introduction of Nickel metal hydride batteries accelerated the growth of EVs. The negative electrode of NiMH follows the process of intercalation, a smoother process than redox reaction in other electrochemical cells [10]. NiMH has a higher self-discharge rate but its higher energy density makes them suitable for hybrid electric vehicles. Li-ion cells have both the electrodes undergoing an intercalation process [10]. Additionally, the higher energy density, longer life, and no memory effect makes them a strong alternative for use in EVs [11]. This drastically improved battery performance. High energy density, long life, low self-discharge rate were the main advantages of Li-ion cells [12]. However, the operating temperature is very low, thus battery failure may lead to serious damages [13]. Overcoming these disadvantages of Li-ion batteries, Lithium based Solid State Batteries (SSBs) were introduced which as the name suggest uses a solid electrolyte instead of liquid electrolyte for ion conduction. It offers no thermal runaway and hence wide operating range [14].

The paper is organized as follows: section I I discusses major battery types used in electric vehicle applications, and section I I I compares various parameters of the batteries discussed here and the drive cycles obtained from the E Bike also has been depicted. A retrofitting method was used and spacing for the batteries have been calculated and the range obtained by using different batteries is studied. And finally, the paper is concluded by discussing the different cost constraints and the scope of future expansion.

## 2. MAJOR BATTERIES USED FOR EV APPLICATIONS

### 2.1 Lead Acid Battery

Lead acid batteries originally invented in the 19th century went through different changes and advancement to the product that it is of today. Lead acid battery, being the very commercialized battery in older generation as it was introduced in 1859 [15]. The major advantages of these batteries are low cost, high electrical activity, high reliability, fast response, strong surge capacity and efficiency ranging from 60 to 80% [16]. The electrodes, separator and electrolyte constitute the internal structure of the battery. The anode is made of lead plates and cathode made of lead oxide plate is immersed in electrolyte solution of sulphuric acid. The electrodes turn into lead sulphate and electrolyte becomes water during the discharge process [17]. Fig. 1 shows the structure of lead acid battery.

The chemical reaction equation of lead acid battery.

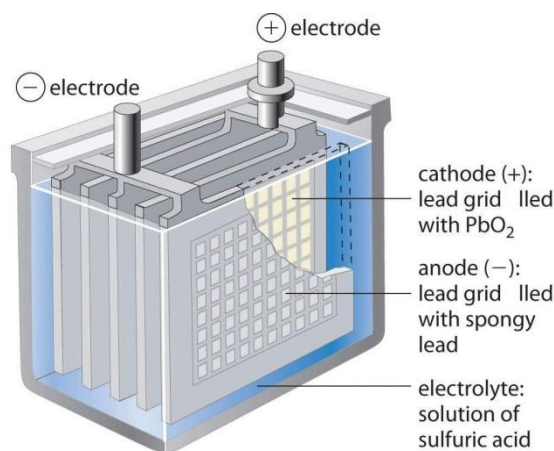
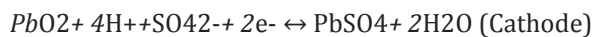

Fig -1: Cutaway of Lead Acid Cell [18]

Low cost, abuse withstanding features, reliable, robust, low internal impedance are some key features. Indefinite shelf life if stored without electrolyte, can be left on float charge for a long period [19]. Wide range of sizes and capacities available and is the world's most recycled product. While the demerits include Coulombic charge efficiency being only 70% in general, and also have the danger of overheating during charging, which is not suitable for fast charging (compared to other batteries) [20]. Applications include automotive and traction applications, emergency power for electrical installations, used in submarines, UPS and other commercial uses.

### 2.2 Nickel Metal Hydride Battery

Nickel-metal hydride battery is a rechargeable alkaline type which is one among the leading battery technologies in the hybrid electric vehicle industry [21]. NiMH batteries are characterized by high energy density, extended service life, safety, high power, environment friendly and recyclability [22]. It can be produced in sizes varying from a few milli ampere hours to hundreds of ampere hours [23]. Structure and cell reactions of NiMH batteries are briefly discussed in this section. Fig. 2 depicts the structure of NiMH battery.

NiMH battery is called an alkaline storage battery since it uses Potassium Hydroxide as its electrolyte [23]. KOH has a high conductivity factor and the ability to remain inert during the cell reaction which resulted in high conductivity throughout its battery life [22]. KOH plays a vital role in keeping the overcharge and over discharge performance better in NiMH batteries as KOH concentration remains constant in the entire process of charging and discharging [25,26].

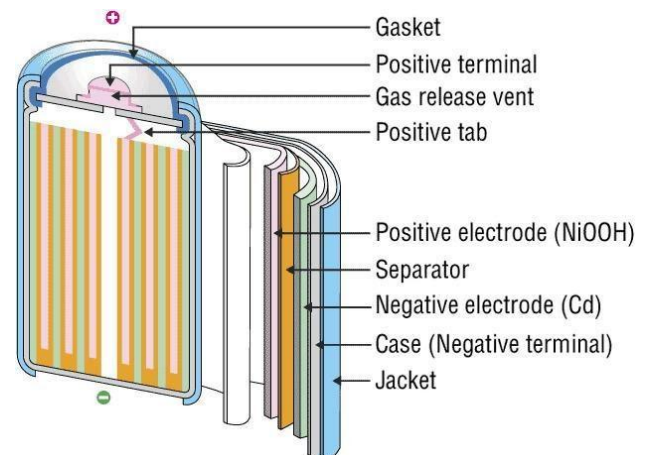
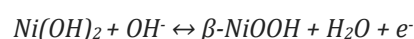

Fig -2: Cutaway of cylindrical NiMH cell [24]

NiMH battery has Nickel Hydroxide as its positive electrode. It is nonstoichiometric and has better gravimetric and volumetric energy densities [27]. Battery life and abuse tolerance are enhanced by nickel electrodes because of its insolubility property in KOH electrolyte [23]. Nickel electrode has two different polymorphic forms,  $\alpha$ -Ni(OH)<sub>2</sub> and  $\beta$ -Ni(OH)<sub>2</sub>. But  $\beta$ -Ni(OH)<sub>2</sub> is used as a positive electrode as it improves the electrochemical property of the electrode due to its irregular tabular shape and high-density structural disorder [28].

Positive electrode reaction is written as:



NiMH battery has hydrogen absorbing alloys as its negative electrode. It is capable of absorbing hydrogen thousand times more than the volume of itself. The

mechanism by which it absorbs and desorbs hydrogen is called intercalation and deintercalation respectively. The cells work at low pressure and are safe. Hydrogen absorbing alloy is made by combining 2 different metals say, A and B. Hydride of metal A should be able to produce heat exothermically while hydride of meal B should be able to produce heat endothermically [23]. These two metals can be combined in four ways [29]; AB<sub>5</sub>, AB<sub>2</sub>, AB and A<sub>2</sub>B. Among these, the most suitable form for battery application is AB<sub>5</sub> based on its long life, charge and discharge efficiency [23].

Negative electrode reaction is written as:

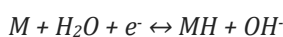

Separator is used in liquid electrolyte batteries to prevent electrical short circuiting by keeping two electrodes apart while it allows the transportation of ionic charge carriers. Generally, the metal grid or sheet which provides a better conducting path is used as a collector current. Excessive gases produced during overcharging or shorting is removed through the safety vent [23]. Overall cell reaction is given as:

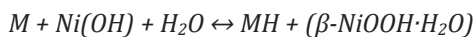

NiMH batteries also have many disadvantages. Its main drawbacks are self-discharging and negative electrode corrosion which depends on the temperature. Therefore, it needs a system that can manage temperature to have better charging efficiency and long life [30]. It also works improper at low and high temperatures [31].

NiMH are used in a variety of applications which includes mainly hybrid electric vehicles and stationary power applications like energy storage for telecom, UPS and distributed generation applications [22]. NiMH battery technology is used for vehicles like Toyota Prius. Toyota Prius, a hybrid electric vehicle used NiMH for the first time [21].

### 2.3 Lithium-Ion Battery

Lithium-ion batteries are used in a broad spectrum of applications from portable devices like mobile phones to satellites due to a variety of reasons discussed in this section. Li ion batteries have many chemistries which are used for EV applications. Each one of them differ in terms of energy density, life cycles, durability, safety issues under overcharge and over discharge conditions. Both the electrodes of Li-ion cells work on the Intercalation process. In this process Lithium does not react with electrodes but they are either absorbed from the electrolyte and inserted to electrode or removed from electrode to electrolyte through deintercalation [10].

The cell has a positive electrode, negative electrode, electrolyte, separator and current collector. Electrons are

gained by the positive electrode from the external circuit during the discharge process. Electrons are given up by the positive electrode to the external circuit during the charging process. Fig. 3. shows the structure of the Li-ion cell.

The electrolyte, media that conducts ions between electrodes, used in Li-ion cells contains salt, acid or base dissolved in solvent [10].

The negative electrodes (anode) used are generally graphitic carbon. There are many other varieties too. The other anodes used are LTO (Li<sub>4</sub>Ti<sub>5</sub>O<sub>12</sub>) and Silicon. LTO has a high open circuit potential of negative electrodes thus reduces the overall cell voltage. Silicon electrode is also used as anode, offers higher energy density but has a short life cycle [32].

Current collector material is selected such that it can withstand the harsh environment inside the cell and normal environment outside the cell. The positive current collector generally used is Aluminium foil and the negative current collector used is Copper foil [10].

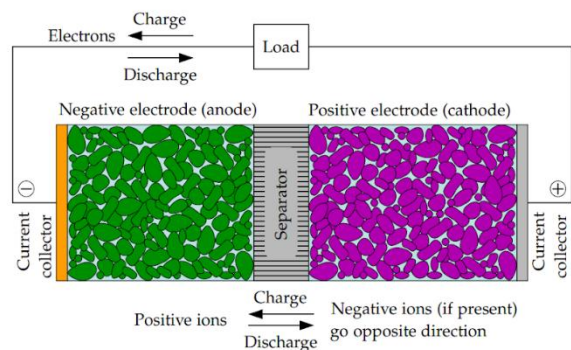

Fig -3: Li-ion cell schematic diagram [10]

The positive electrode (cathode) used for E applications in lithium-ion batteries are Lithium Cobalt Oxide (LiCoO<sub>2</sub>, LCO), Lithium Manganese Oxide (LiMn<sub>2</sub>O<sub>4</sub>, LMO/Spinel), Lithium Iron Phosphate (LiFePO<sub>4</sub>, LFP) and Lithium Mixed Nickel-Manganese-Cobalt Oxide (LiNi<sub>1-y-z</sub>Mn<sub>y</sub>Co<sub>z</sub>O<sub>2</sub>, NMC). The performance of these electrodes is compared in the table 1. [32].

Table -1: Positive Electrodes of Li-ion Cell [32]

Specifications	LCO	LMO	LFP	NMC
Nominal Voltage (V)	3.90	3.70	3.40	3.60 to 3.70
Cycle life	500	500 to	1000 to	1000 to

		1000	2000	2000
Operating Temp	Average	Average	Good	Good
Specific energy (Wh/kg)	155	100 to 200	160	200
Specific power	1C	10C, 40C	35C	10C
Safety	Poor	Average	Very good	Good
Cost	High	Low	Average	Average

By referring to Table 1. conclusions made are such. Among these chemistries of Li-ion batteries LCO based batteries have high energy density and power density. But there is a trade-off that has to be done such that Cobalt metal is toxic as well as expensive. NMC based Li-ion batteries are safer, cheaper and at the same time offer higher energy density [32]. As a result, NMC based Li-ion batteries are widely used in EV applications. LMO based Li-ion batteries have lower cost, better safety than LCO but have a shorter life cycle. Even though LPF based batteries have low nominal voltage, it has better safety, good thermal stability and lower cost. So LPF based batteries are also used in EV applications.

### 2.4 Solid State Battery

The Li-ion batteries have some serious drawbacks due to narrow operating temperature the chance for thermal runaway is high. Thus, to avoid that costly and sophisticated protection and voltage balancing circuits are essential. The EV industry is always in search of better chemistries and methods to improve safety and range of EV. The use of Solid-state batteries can fix these problems to a great extent. The Lithium based SSBs can replace the liquid electrolyte with solid electrolytes and thus receive the name solid state battery. Due to these top features major automobile companies like Toyota, BMW, Hyundai, Volkswagen, etc. have collaborated with SSB manufacturers in order to increase safety, provide longer range, faster charging, etc. More about SSB technologies are in great detail in this session [33].

Solid State Li-ion batteries are one of the best battery technologies developed in terms of safety and volumetric energy density [7]. Unlike other batteries discussed SSBs have solid electrolyte, here amorphous  $\text{Li}_3\text{PO}_4$  is used as a solid electrolyte, Li metal is used as the negative electrode and  $\text{LiCoO}_2$  is used as the positive electrode [34]. The ion transport mechanism in SSB can happen in three different ways- There is vacancy diffusion where the ions occupy the vacant spaces in the neighbouring site, Direct

interstitial method of flowing ions and third mechanism happens by which a ion colliding with a stable ion to create a metastable ion [35].

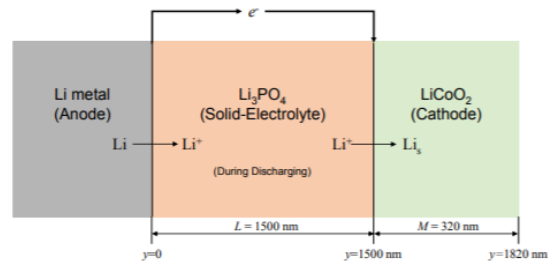

Fig -4: Schematics of ion transportation in SSB [34]

The Solid electrolytes can vary according to the battery selected and usually are of three types. Solid Oxide electrolyte which has high chemical stability and is non-toxic when decomposed. Glass comes under this category and has very high thermal resistance and is suitable as an electrolyte. It works as an effective separator between electrode materials. The second classification is the Solid Sulphide Electrolyte which has high ionic conduction and low grain boundary size which makes it possible to manufacture bulk type batteries. Third category is Solid polymer electrolytes that have good flexibility and are safer and less inflammable but these electrolytes have poor mechanical properties [34]. The Cycle life of SSB is a crucial parameter to indicate its performance when used in an electric vehicle. There are many mechanical, chemical and electrochemical factors that affect the life of the SSB [35].

Further improvements can be made in interface stability and reducing interface resistance by modifying the electrolyte/electrode interface. Inhibiting lithium dendrites growth is also a necessary step to prevent accidents which can be done by improving the anode interface or structure of anode [36].

### 3. METHODOLOGY & COMPARISON

Out of all the battery technologies listed here, Solid state batteries are found to be better in many aspects. Solid state batteries have the highest energy density of 380Whkg-1[37] and is superior to lithium-ion batteries which have around 270Whkg-1. In terms of Power density, lead acid and nickel cadmium batteries were limited to around 180Wkg-1 where as nickel metal hydride was much better as it provided upto 1000Wkg-1. Li-ion batteries were a leap in terms of power density. It can provide upto 1800Wkg-1[38]. Self-discharge rate of a battery is a very useful tool to analyse the performance of a battery. Lead Acid Batteries have a very high self-discharge rate. The self-discharge rate of NiMH hydride is high but its higher energy and power density makes them suitable for Hybrid Electric Vehicles. Lithium-Ion batteries

have a very low self-discharge rate, high power density, high energy density, and no memory effect makes them suitable for Battery Electric Vehicles [39].

Safety is the primary concern in any application. Vehicle safety is related with the prevention of crashes and its precaution is taken in its design. In the context of battery, elimination of fire hazard is important. Fire hazard from the battery happens due to thermal runaway. It is a spontaneous event caused due to short circuit of battery terminals and can result in excessive heating and explosion [40]. This is the major drawback of Li-ion batteries. Therefore, monitoring systems are required for ensuring the safety [41]. For Solid state battery technology, the operating temperature range is sufficiently wide so that battery safety is increased even though specific energy is high.

For the purpose of this paper, the concept of retrofitting an ICE bike to an EV was used. Bajaj Pulsar 150, a popular ICE bike in India was chosen here. The space for replacing the IC engine with motor, battery and motor controller were estimated. The fig. 5 shows the chassis of the bike chosen. A 3kW BLDC (brushless DC) motor with chain drive was placed at a convenient position as shown in fig. 6. Due to higher efficiency, reliability and affordable price, BLDC was found to be the best suit for this application. [42]

After placing the motor, the space left for fixing the battery was calculated. The volume left for battery accommodation was found to be 360mm x 170mm x 280mm which equals 17.36 litre.

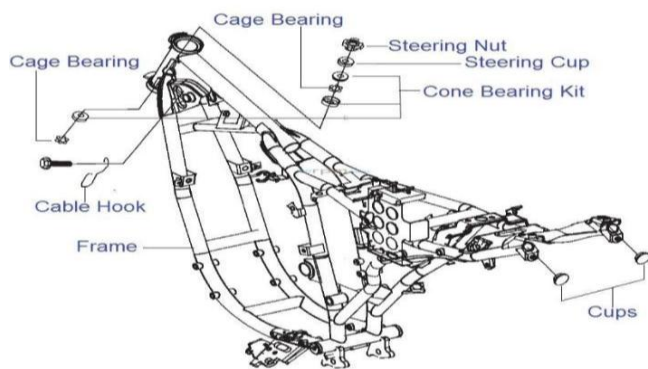

Fig -5: The chassis of the used bike [43]

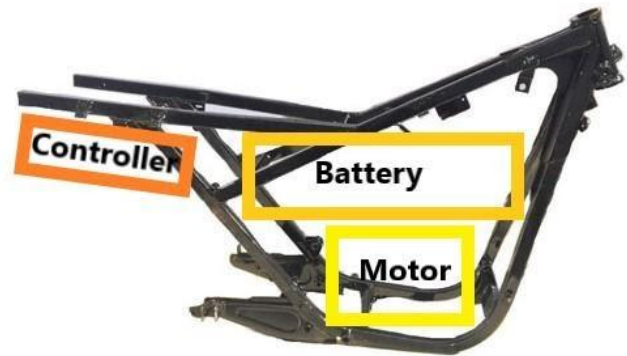

Fig -6: The allocation of components on the chassis

From table 2 the maximum possible energy that can be stored in the estimated space is calculated for different batteries.

A. Lead acid battery:

Volumetric energy density: 100Wh/L

$$\text{Max. energy that can be stored in } 17.36\text{L} = 17.36 \times 100 = 1736 \text{ Wh}$$

B. Nickel metal hydride battery:

Volumetric energy density: 140 Wh/L

$$\text{Max. energy that can be stored in } 17.36\text{L} = 17.36 \times 140 = 2430.4 \text{ Wh}$$

C. Lithium-ion battery:

Volumetric energy density: 270 Wh/L

$$\text{Max. energy that can be stored in } 17.36\text{L} = 17.36 \times 270 = 4687.2 \text{ Wh}$$

D. Solid state battery:

Volumetric energy density: 620 Wh/L

$$\text{Max. energy that can be stored in } 17.36\text{L} = 17.36 \times 620 = 10763.2 \text{ Wh}$$

The set of points representing the speed of a Vehicle with respect to time is known as driving cycle. The driving cycle can be classified into 2 groups, transient driving cycle and modal driving cycle. Since it represents the nature of roads, different countries have different driving cycles. [47] Driving cycle in USA is FTP-75 (Federal Test Procedure), in Europe its ARTEMIS (Assessment and Reliability of Transport Emission Models and Inventory System) and NEDC (New European Driving Cycle), and worldwide its WLTP (World Harmonized light vehicles test procedure).

**Table -2:** Comparison of various batteries for EVs  
[39,44,45,46]

Battery type	Lead Acid	NiMH	Li-ion	Solid State
Specific Energy (Wh/kg)	30-50	60-120	110-270	380
Energy Density (Wh/L)	60-100	100-140	240-280	620
Power Density (W/kg)	180	250-1000	1800	>1800
Nominal Voltage	2V	1.25V	3.6V	~4.2V
Rate of Self Discharge	Low	High	Very low	Very low
Operating Temperature	-20 to 60°C	-20 to 60°C	-20 to 60°C	-40 to higher than 120°C
Cycle Life	200-300	300-500	500-1000	>1000
Safety	Very Good	Good	Bad-Need protection	Very Good
Cost	Low	Moderate	High	High at present

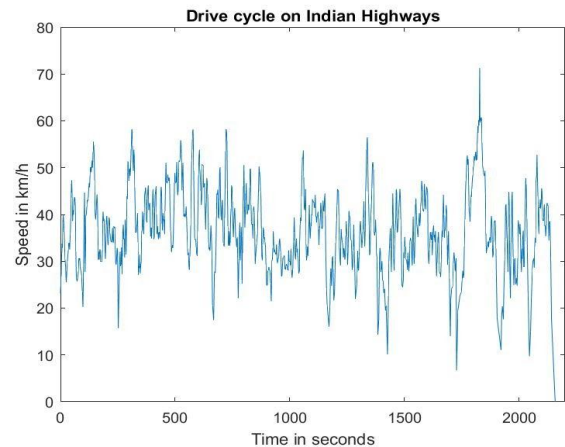

**Chart -1:** The drive cycle obtained by driving the E-bike in highways in India

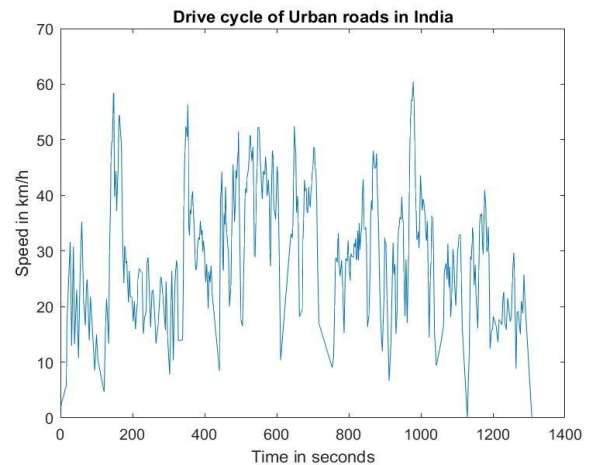

**Chart -2:** The drive cycle obtained by driving the E-bike in urban roads in India

In the Indian road the average speed of a 2-wheeler was found to be 40km/h in highways and 29km/h in urban roads from the drive cycle, shown in Chart 1 and 2 respectively. The speed-time graph of highway roads and urban roads in Kerala, India was plotted using data collected from Speed View Pro mobile application. The plotting was done using MATLAB software. Considering the drivers aggressiveness in ordinary condition, at an average speed of around 29 km/h to 40km/h the energy consumption per km was found to be near to 100Wh. [48]. The maximum possible range of the bike with only 17.36L space for battery allocation was calculated based on the above data. The range of the lead acid battery was found to be lowest with 17.36km, NiMH gave a range of 24.30km, Li-ion gave a larger range of 46.87km and Solid-state battery gave an estimated range of over 100km. With mass production and commercialization, the price of SSBs are expected to come down.

The basic characteristics of the drive cycle plots obtained in 2 different conditions of Indian roads are depicted in table 3 shown below.

**Table -3:** Properties of Drive Cycle Obtained

Type	Avg. Speed (km/h)	Max. Speed (km/h)	Total Distance Covered (km)	Effective Running Time (minute)
Highway	39.82	71.34	21.47	36
Urban	25.36	60.37	9.21	22

Due to lower energy density the range obtained with Lead acid battery was also found to be very less and thus its used in EVs where the expected range is very low. When price is a major concern in some cases PbA batteries are preferred.

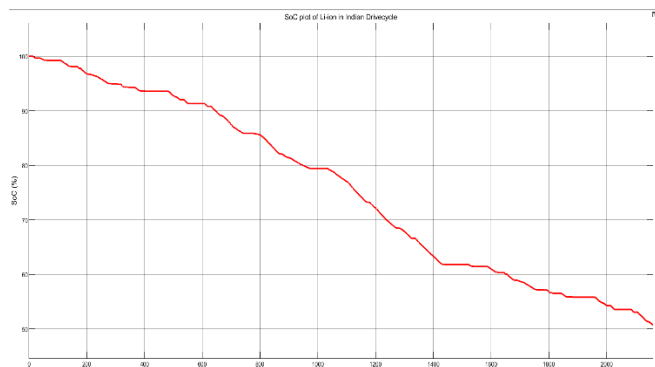

**Chart -3:** The plot of SoC of Li-ion battery in Highways in India

In India, many E-rickshaws use PbA batteries. The Lead acid batteries are the cheapest which can be used for EV applications and are used by Lohia's Electric 3 Wheelers (HUMRAHI PASSENGER) in India [49].

The self-discharge rate of NiMH hydride is high but its higher energy and power density makes them suitable for Hybrid Electric Vehicles. Lithium-Ion batteries have a very low self-discharge rate, high power density, high energy density, and no memory effect makes them suitable for Battery Electric Vehicles [50]. The results also show that a range of 48.6km can be obtained by retrofitting.

Due to the very high initial cost of SSB, at present, Li-ion batteries were preferred by an engineering trade-off. And it was implemented in the bike by retrofitting and the calculated results matched the practical range. Chart 3 shows the plot of SoC obtained with Li-ion in Indian Highways. The motor and battery sizing is beyond the scope of this paper and can be discussed in the future. Fig 7 shows the retrofitted e-bike.



**Fig -7:** The retrofitted bike for with Li-ion battery

#### 4. CONCLUSIONS

The main battery types used in EV applications were studied and compared. It is expected that with more sound research in electrolytes SSBs can replace conventional Lithium-Ion batteries mainly because of safety, high energy and power density factors. By considering the space constraints for allocating the battery, the possible range for different batteries were estimated in the retrofitted model. SSBs promise higher vehicle range than all the other battery chemistries discussed in the paper. At present the cost of Solid-State Batteries are high but it's

expected to be decremented because of mass production. In future, EVs can attain a range higher than 800kms with developments in SSBs. Better and advanced battery technologies are also possible for EV applications like Zinc Air batteries and Lithium Air Batteries.

#### REFERENCES

- [1] C. C. Chan and K. T. Chau, "EV and HEV developments," in *Modern Electric Vehicle Technology*, Oxford University Press, 2001.
- [2] E. Hesla, "Electric Propulsion [History]," in *IEEE Industry Applications Magazine*, vol. 15, no. 4, pp. 10-13, July-Aug. 2009, doi: 10.1109/MIAS.2009.932594.
- [3] M. Guarnieri, "When Cars Went Electric, Part 2 [Historical]," in *IEEE Industrial Electronics Magazine*, vol. 5, no. 2, pp. 46-53, June 2011, doi: 10.1109/MIE.2011.941122.
- [4] A. Oceano, G. Rodella, G. Brusaglino, L. P. Di Noia and R. Rizzo, "Addressing minimum energy consumption and minimum CO2 emission for Electric Mobility," 2019 International Conference on Clean Electrical Power (ICCEP), Otranto, Italy, 2019, pp. 358-363, doi: 10.1109/ICCEP.2019.8890221.
- [5] Wolfram, Paul, and Nic Lutsey. "Electric vehicles: Literature review of technology costs and carbon emissions." *The International Council on Clean Transportation: Washington, DC, USA (2016): 1-23.*
- [6] Hoehne, Christopher G., and Mikhail V. Chester. "Optimizing plug-in electric vehicle and vehicle-to-grid charge scheduling to minimize carbon emissions." *Energy 115 (2016): 646-657.*
- [7] M. Austin, "IEEE Transportation Electrification Community," Dec-2013
- [8] S. Sharma, P. Sarma, S. Bordoloi and P. Barman, "Estimation of coulombic efficiency of lead acid battery for range determination of electric vehicle," 2015 1st Conference on Power, Dielectric and Energy Management at NERIST (ICPDEN), Itanagar, 2015, pp. 1-6, doi: 10.1109/ICPDEN.2015.7084501.
- [9] M. Disosway, "Development of high power nickel-cadmium batteries for hybrid vehicles," Thirteenth Annual Battery Conference on Applications and Advances. Proceedings of the Conference, Long Beach, CA, USA, 1998, pp. 19-23, doi: 10.1109/BCAA.1998.653832.
- [10] Plett, Gregory L.. *Battery Management Systems, Volume I: Battery Modeling*. United Kingdom: Artech House, 2015.

- [11] Han, Xuebing & Ouyang, Minggao & Lu, Languang & Jianqiu, Li. (2014). A comparative study of commercial lithium ion battery cycle life in electric vehicle: Capacity loss estimation. *Journal of Power Sources*. 268. 10.1016/j.jpowsour.2014.06.111.S. Rahardian, B. A. Budiman, P. Lebdo Sambegoro and I. P. Nurprasetyo, "Review of Solid-State Battery Technology Progress," 2019 6th International Conference on Electric Vehicular Technology (ICEVT), Bali, Indonesia, 2019, pp. 310-315, doi: 10.1109/ICEVT48285.2019.8993863.
- [12] Z. Lei, C. Zhang and J. Li, "Research on the low performance of power lithium-ion battery in electric vehicle," 2014 IEEE Conference and Expo Transportation Electrification Asia-Pacific (ITEC Asia-Pacific), Beijing, 2014, pp. 1-5, doi: 10.1109/ITEC-AP.2014.6941157.
- [13] B. Ji, X. G. Song, W. P. Cao and V. Pickert, "Active temperature control of Li-ion batteries in electric vehicles," IET Hybrid and Electric Vehicles Conference 2013 (HEVC 2013), London, 2013, pp. 1-5, doi: 10.1049/cp.2013.1916.
- [14] C. R. Stoldt and S. -. Lee, "All-solid-state lithium metal batteries for next generation energy storage," 2013 Transducers & Eurosensors XXVII: The 17th International Conference on Solid-State Sensors, Actuators and Microsystems (TRANSDUCERS & EUROSENSORS XXVII), Barcelona, 2013, pp. 2819-2822, doi: 10.1109/Transducers.2013.6627392.
- [15] A. K. M. Ahasan Habib, S. M. A. Motakabber and M. I. Ibrahimy, "A Comparative Study of Electrochemical Battery for Electric Vehicles Applications," 2019 IEEE International Conference on Power, Electrical, and Electronics and Industrial Applications (PEEIAACON), Dhaka, Bangladesh, 2019, pp. 43-47, doi: 10.1109/PEEIAACON48840.2019.9071955.
- [16] D. K. Bhatt and M. El. Dariaby, "An Assessment of Batteries form Battery Electric Vehicle Perspectives," 2018 IEEE International Conference on Smart Energy Grid Engineering (SEGE), Oshawa, ON, 2018, pp. 255-259, doi: 10.1109/SEGE.2018.8499462.
- [17] P. G. Horkos, E. Yammine and N. Karami, "Review on different charging techniques of lead-acid batteries," 2015 Third International Conference on Technological Advances in Electrical, Electronics and Computer Engineering (TAECE), Beirut, 2015, pp. 27-32, doi: 10.1109/TAECE.2015.7113595.
- [18] "Sodium Perborate Tetrahydrate Additive for lead acid battery manufacturing - Shaoxing Biotech Chemical", Biochemicals.cn. [Online]. Available: <http://www.biochemicals.cn/sodium-perborate-additive-lead-acid-battery.html>.
- [19] E. Banguero, A. Correcher, A. Pérez-Navarro and E. García, "State of health estimation of lead acid battery bank in a renewable energy system by parameter identification with genetic algorithms," 2018 7th International Conference on Systems and Control (ICSC), Valencia, 2018, pp. 418-423, doi: 10.1109/ICoSC.2018.8587801.
- [20] P. M. Hunter and A. H. Anbuky, "VRLA Battery Virtual Reference Electrode: Battery Float Charge Analysis," in *IEEE Transactions on Energy Conversion*, vol. 23, no. 3, pp. 879-886, Sept. 2008, doi: 10.1109/TEC.2008.926041.
- [21] J. P. Aditya and M. Ferdowsi, "Comparison of NiMH and Li-ion batteries in automotive applications," 2008 IEEE Vehicle Power and Propulsion Conference, Harbin, 2008, pp. 1-6, doi: 10.1109/VPPC.2008.4677500
- [22] Kopera, 'Inside the Nickel Metal Hydride Battery.', Cobasys, 2004.
- [23] J. Tarabay and N. Karami, "Nickel Metal Hydride battery: Structure, chemical reaction, and circuit model," 2015 Third International Conference on Technological Advances in Electrical, Electronics and Computer Engineering (TAECE), Beirut, 2015, pp. 22-26, doi: 10.1109/TAECE.2015.7113594
- [24] "BAJ Website," Baj.or.jp. [Online]. Available: <http://www.baj.or.jp/e/knowledge/structure.html>. [Accessed: 03-Dec-2020].
- [25] Han, J., Feng, F., Geng, M., Buxbaum, R., & Northwood, D. O. (1999). Electrochemical characteristics of the interface between the metal hydride electrode and electrolyte for an advanced nickel/metal hydride battery. *Journal of Power Sources*, 80(1), 39-45.
- [26] Iwakura, C., Nohara, S., Furukawa, N., & Inoue, H. (2002). The possible use of polymer gel electrolytes in nickel/metal hydride battery *Solid State Ionics*, 148(3), 487-492.
- [27] "Modern Battery Technology," Center for Professional Advancement, 1995, Dr. Forrest A. Trumbore ed.
- [28] Shruthi, B., Raju, V. B., & Madhu, B. J. (2015). Synthesis, spectroscopic and electrochemical performance of pasted  $\beta$ -nickel hydroxide electrode in alkaline electrolyte. *Spectrochimica Acta Part A: Molecular and Biomolecular Spectroscopy*, 135, 683-689.
- [29] Broom, D. P. (2011). *Hydrogen storage materials: the characterisation of their storage properties*. Springer Science & Business Media
- [30] Menahem Anderman, Fritz R. Kalhammer, Donald MacArthur, "Advanced Batteries for Electric Vehicles:



- An Assessment of Performance, Cost and Availability”, for State of California Air Resources Board, June 2000
- [31] Menahem Anderman, Fritz R. Kalhammer, Donald MacArthur, “Advanced Batteries for Electric Vehicles: An Assessment of Performance, Cost and Availability”, for State of California Air Resources Board, June 2000
- [32] X. Chen, W. Shen, T. T. Vo, Z. Cao and A. Kapoor, "An overview of lithium-ion batteries for electric vehicles," 2012 10th International Power & Energy Conference (IPEC), Ho Chi Minh City, 2012, pp. 230-235, doi: 10.1109/ASSCC.2012.6523269.
- [33] A. Bindra, "Electric Vehicle Batteries Eye Solid-State Technology: Prototypes Promise Lower Cost, Faster Charging, and Greater Safety," in IEEE Power Electronics Magazine, vol. 7, no. 1, pp. 16-19, March 2020, doi: 10.1109/MPEL.2019.2961203.
- [34] K. Upreti, I. Oyewole, X. Lin and Y. Kim, "On Simplification of a Solid-State Battery Model for State Estimation," 2019 IEEE Conference on Control Technology and Applications (CCTA), Hong Kong, China, 2019, pp. 487-492, doi: 10.1109/CCTA.2019.8920519.
- [35] S. Rahardian, B. A. Budiman, P. Lebdo Sambegoro and I. P. Nurprasetio, "Review of Solid-State Battery Technology Progress," 2019 6th International Conference on Electric Vehicular Technology (ICEVT), Bali, Indonesia, 2019, pp. 310-315, doi: 10.1109/ICEVT48285.2019.8993863.
- [36] C. R. Stoldt and S. -. Lee, "All-solid-state lithium metal batteries for next generation energy storage," 2013 Transducers & Eurosensors XXVII: The 17th International Conference on Solid-State Sensors, Actuators and Microsystems (TRANSDUCERS & EUROSENSORS XXVII), Barcelona, 2013, pp. 2819-2822, doi: 10.1109/Transducers.2013.6627392.
- [37] K. Kerman, A. Luntz, V. Viswanathan, Y. M. Chiang, Z. Chen, "Review- practical challenges hindering the development of solid state li-ion batteries", J. Electrochem. Soc., 2017, vol. 164, pp. A1731-A1744 [DOI:10.1149/2.1571707jes].
- [38] Wu, Zhijun & Xie, Zhengkun & Yoshida, Akihiro & Wang, Zhongde & Hao, Xiaogang & Abudula, Abuliti & Guan, Guoqing, 2019. "Utmost limits of various solid electrolytes in all-solid-state lithium batteries: A critical review," Renewable and Sustainable Energy Reviews, Elsevier, vol. 109(C), pages 367-385.
- [39] K.E. Aifantis, S.A. Hackney, and R.V. Kumar, "High Energy Density Lithium Batteries, Materials, Engineering, Applications," Wiley-Vch Verlag GmbH & Co. KGaA, Weinheim, 2010
- [40] W. Sutopo, D. I. Maryanie, A. Purwanto and M. Nizam, "A comparative value chains analysis of battery technologies for electric vehicles," 2013 Joint International Conference on Rural Information & Communication Technology and Electric-Vehicle Technology (rICT & ICeV-T), Bandung, 2013, pp. 1-5, doi: 10.1109/rICT-ICeVT.2013.6741514.
- [41] P. L. Sambegoro, B. A. Budiman, E. Philander and M. Aziz, "Dimensional and Parametric Study on Thermal Behaviour of Li-ion Batteries," 2018 5th International Conference on Electric Vehicular Technology (ICEVT), Surakarta, Indonesia, 2018, pp. 123-127, doi: 10.1109/ICEVT.2018.8628404.
- [42] M. S. Patil and S. S. Dhamal, "A Detailed Motor Selection for Electric Vehicle Traction System," 2019 Third International conference on I-SMAC (IoT in Social, Mobile, Analytics and Cloud) (I-SMAC), Palladam, India, 2019, pp. 679-684, doi: 10.1109/I-SMAC47947.2019.9032616.
- [43] "Body Frame: Pulsar 150 UG4 \*PNF\*," 99rpm. [Online]. Available: <https://www.99rpm.com/bajaj/parts/body/frame/body-frame-pulsar-150-ug4-pnf.html>. [Accessed: 03-Dec-2020].
- [44] Takeshi Kobayashi, Yuki Imade, Daisuke Shishihara, Kenji Homma, Miki Nagao, Ryota Watanabe, Toshiyuki Yokoi, Atsuo Yamada, Ryoji Kanno, Takashi Tatsumi, "All solid-state battery with sulfur electrode and thio-LISICON electrolyte", Journal of Power Sources, Volume 182, Issue 2, 2008
- [45] A. K. M. Ahasan Habib, S. M. A. Motakabber and M. I. Ibrahimy, "A Comparative Study of Electrochemical Battery for Electric Vehicles Applications," 2019 IEEE International Conference on Power, Electrical, and Electronics and Industrial Applications (PEEIACON), Dhaka, Bangladesh, 2019, pp. 43-47, doi: 10.1109/PEEIACON48840.2019.9071955.
- [46] Wu, L. Yuan, W. Zhang, Z. Li, X. Xie and Y. Huang, "Reducing the thickness of solid-state electrolyte membranes for high-energy lithium batteries", Energy & Environmental Science, 2020. Available: 10.1039/d0ee02241a [Accessed 5 December 2020].
- [47] A. R. Mahayadin and I. Ibrahim, "Development of Driving Cycle Construction Methodology in Malaysia's Urban Road System," 2018 Int. Conf. Comput. Approach Smart Syst. Des. Appl., pp. 1-5, 2018.
- [48] "Evaluation of EVs energy consumption influencing factors, driving conditions, auxiliaries use, drivers aggressiveness," 2013 World Electric Vehicle Symposium and Exhibition (EVS27), 2013.

- [49] "Lohia: Electric Rickshaw", Lohiaauto.com. [Online]. Available:<https://lohiaauto.com/humrahi-passenger.php>.
- [50] K.E. Aifantis, S.A. Hackney, and R.V. Kumar, "High Energy Density Lithium Batteries, Materials, Engineering, Applications," Wiley-Vch Verlag GmbH & Co. KGaA, Weinheim, 2010