

# Novel Approach to Diagnose Chronic Kidney Disease (CKD) with Predicted Pathophysiological Parameter using Neural Network and Fuzzy Logic

Ketan K. Acharya<sup>1</sup>, Utpal T. Pandya<sup>2</sup>

<sup>1</sup>Asst. Professor –Dept of IC Engineering- Govt. Engineering College Gandhinagar ,Ph.D Research Scholar, Gujarat Technological University(GTU), Gujarat, India

<sup>2</sup>Professor- Dept of IC Engineering-Sarvajanik College of Engg & Technology (GTU), Surat ,Gujarat, India

\*\*\*

**Abstract** - Today, chronic diseases are booming day by day in our country due to life style of an individual and due to their hereditary issues. Certain patho physiological parameters as well as vital signs are monitored and based on that, proper diagnosis of diseases and early stage prediction is one of the major research areas in the field of medical instrumentation and computer science. Many errors occurring in healthcare are related to the lack of availability of important patient-related medical information. According to researchers, the use of information and communication technologies (ICTs) hold promise for increasing the accessibility of medical information and it is essential for patient safety.[8][9]

In this research an approach is suggested which is a combination of considering pathophysiological parameters related to renal abnormality, predicted value of pathophysiological parameter using Neural Network (NN) and real time measurement of vital signs. A Diagnosis Support System (DSS) is suggested which consider all these parameters to diagnose renal function abnormality and finally it gives diagnosis of chronic kidney disease (CKD)

**Key Words:** DSS (Diagnosis and Support System), NN (Neural Network), CKD (Chronic Kidney Disease), BMI (Body Mass Index), BUN (Blood Urea Nitrogen)

## 1. INTRODUCTION

Medical diagnosis is a complicated and judgmental Process, which depends largely on experience, judgment and reasoning which essentially are the functions of human brain. Medical knowledge derived from books and literatures, data obtained from various pathological tests are also required to reach to conclusion of diagnosis. However, diagnostic decisions made by physicians are arbitrary and highly variable (within one physician and between physicians) and often lack explanation or rationalization. In developing countries, doctors are scarcely available in rural areas. A recent statistical data shows that 75% of qualified consulting doctors reside in urban areas and another 23% in semi urban areas, and only about 2% of doctors reside in rural areas of country like India, where, unfortunately , nearly 78% of Indians reside. [3]

This has created an unwarranted imbalance in patient-doctor ratio. [3] Research is going on in the area of medical instrumentation where based on various physiological parameters and vital signs detected using wearable sensors and other measured values, abnormalities of patients are detected in early stage and disease related diagnosis is also done based on the available data of patients. Various techniques like big data, deep learning and data mining are generally used for diagnosis of diseases and early stage prediction. [1] IoT based approach is used for transmitting patients' data on cloud and then cloud based data analytics is used for the said purpose. [2].

A medical system, also sometimes referred to as health care system is an organization of people, institutions and resources to deliver health care services to meet the health needs of target populations. Presently diseases in India have emerged as number one killer in both urban and rural areas of the country. It will be of greater value if the diseases are diagnosed in its early stage. [3] Correct diagnosis of the disease will decrease the death rate due to different diseases.

Many clinical tests are being done to find the presence of the disease. In this paper a novel approach for diagnosis of Chronic Kidney Disease is suggested in which a combination of pathophysiological parameters, predicted parameter and real time measurement of certain vital signs can be used for proper diagnosis of chronic kidney disease.

Preliminary symptoms of patient cannot be ignored and based of those symptoms if few pathophysiological parameters are measured and certain parameter is predicted then over all diagnosis becomes fast. And if all these combination of parameters detect abnormality of a patient then it becomes very important to measure vital signs in real time for diagnosis of chronic kidney disease. The proposed approach is a four phased approach. **Phase 1:** Collection of data for pathophysiological parameters of patient which are necessary for renal function abnormality. Here, we have focused on easily measurable parameters out of all parameters related to renal disease or abnormality. **Phase 2:** In this we have predicted one of the most important parameter required for detecting renal function abnormality i.e Creatinine.

**Phase 3:** In this we use predicted parameter i.e Creatinine and other parameters which have already been collected earlier to diagnose renal function abnormality using fuzzification process. **Phase 4:** If criticality of patient is detected in phase 3 then, we have to measure certain vital signs which can give proper diagnosis for Chronic Kidney Disease (CKD)

## 2. Introducing the functions of Kidney (Renal functions) [4] [5]

The kidney has several functions, including the excretion of water, soluble waste, e.g. urea and creatinine and foreign materials, e.g. drugs. It is responsible for the composition and volume of circulating fluids with respect to water and electrolyte balance and acid/base status. It has an endocrine function playing a part in the production of vitamin D and erythropoietin and as part of the renin/angiotensin/aldosterone axis. Measurements of renal function rely on measuring, in various ways the degree to which the kidney is successful in these roles. An assessment of renal function may be required for several reasons:

- To identify renal impairment.
- To monitor disease progress.
- To assess baseline measurements prior to starting treatment with certain drugs.
- To monitor disease progress.

The type of measurement of kidney function performed will be determined by the reason for assessing renal activity.

### 2.1 Overview of Kidney Function Tests [4] [5]

We have two kidneys, each approximately the size of a human fist. They are located in the back of your abdomen, below the rib cage, one kidney on either side of your spine. The kidneys play several vital roles in maintaining health. One of their most important jobs is to filter waste materials from the blood and expel them from the body as urine. The kidneys also help control the levels of water and various minerals in the body.

In addition, they are critical to the production of, vitamin D, red blood cells, hormones that regulate blood pressure. If the doctor thinks our kidneys may not be working properly, you may need kidney function tests. These are simple blood and urine tests that can identify problems with your kidneys.

Kidney function tests may also be ordered if you have other conditions that can harm the kidneys, such as diabetes or hypertension (high blood pressure). They can be used to monitor these conditions.

### 2.2 Types of Kidney Function Tests

To test your kidney function, your doctor will order a set of tests that can be used together to estimate your glomerular

filtration rate (GFR). The GFR tells the doctor how quickly your kidneys are clearing waste from your body. Tests include the following

#### Urinalysis

A urinalysis screens for the presence of protein and blood in the urine. There are many possible causes of protein in your urine, not all of which are related to disease. Infection increases urine protein, but so does a heavy physical workout. This can be used to see how fast a waste product called creatinine is being cleared from your body. Creatinine is a breakdown product of muscle tissue.

#### Serum Creatinine Test

This blood test examines whether creatinine is building up in your blood. Creatinine is usually completely filtered from the blood by the kidneys. Therefore, a high level of creatinine suggests a kidney problem. Normal lab readings in men are 0.7 to 1.3 mg/dL of blood. Normal lab readings for women are 0.6 to 1.1 mg/dL.

#### Blood Urea Nitrogen (BUN)

The BUN test also checks for waste products in your blood. BUN measures the amount of nitrogen in the blood. Urea nitrogen is a breakdown product of protein. However, not all elevated BUN tests are caused by kidney damage. A normal BUN is approximately 6 to 20 mg/dL of blood. A higher value could imply several different health problems.

#### Estimated Glomerular Filtration Rate (GFR)

This test estimates how well your kidneys are filtering waste. The rate is calculated by taking several factors into account, such as: test results, specifically creatinine levels, age, gender, race, height, weight. Any result lower than 60 is a warning sign of kidney disease.

#### Treatment for Early Kidney Disease

If the tests show early kidney disease, your doctor will focus on treating the underlying condition. If it is hypertension, your doctor will prescribe medications to control the blood pressure. He or she will also suggest lifestyle and dietary modifications.

If you have diabetes, your doctor may want you to see an endocrinologist. If there are other causes of abnormal kidney function tests, such as kidney stones and excessive use of analgesics (pain killers), doctor will take appropriate measures to manage those disorders.

### 3. Our Approach to select important parameters for preliminary diagnosis of renal function abnormality.

Based on the symptoms of renal malfunctions and study of various pathophysiological parameters and also based on consultation with doctors following easily measurable parameters are selected for preliminary diagnosis. 1) Patient's Height 2) Patient's Weight OR Based on height and weight BMI can also be measured directly.

$$BMI = [(Weight \text{ in Kgs}) / (Height \text{ in cms})^2] * 10,000.$$

Values of BMI of the patients can also be considered directly. 3) Blood Glucose or direct diagnosed diabetes outcome i.e patient is having diabetes (1) or no (0). 4) Blood Pressure.

All these parameters are easily measurable either with wearable sensors or some devices available in the market and people generally use such devices for the measurement of body parameters like blood pressure and blood glucose. In our approach, purpose is to use easily measurable parameters instead of pathological medical tests so that diagnosis becomes fast and precautions can be started in early stage.

And the most important part is we have predicted an important parameter for diagnosis of renal abnormality i.e Creatinine. Based on the values of BMI, Blood Pressure and Diabetes Outcome, value of Creatinine is predicted using Neural Network.

### 4. Neural Network (NN) based prediction of Creatinine, using collected values of BMI, Diabetes Outcome and Blood Pressure

Recently, soft computing techniques like fuzzy logic and neural networks are gaining considerable importance in the field of automated medical diagnosis. Fuzzy logic is used in situations where approximate values of patient data are to be analyzed using linguistic variables.

Similarly neural networks are used in situations where the knowledge about the patient is stored in the form of numerical data sets. Based on fuzzy systems and neural network, predicted stage of the patient in the form of moderate, normal and critical can be found out. For carrying out this work, the work flow chart as shown in Fig-1 is followed.

For experimental work we have collected database of 769 patients. We have chosen UCI Multirepository Dataset for Machine Learning (UCI- ML) and have preferred online data sets for training a neural network.

Dataset includes data of patients with blood sugar, diabetes outcome, blood pressure, age, and BMI. If BMI is not given,

then based on height and weight as mentioned in point 3 can be calculated.

Out of 769 patients, 550 patients' data are selected for training a neural network. And other 219 data of patients are considered as sample data set in Neural Network.

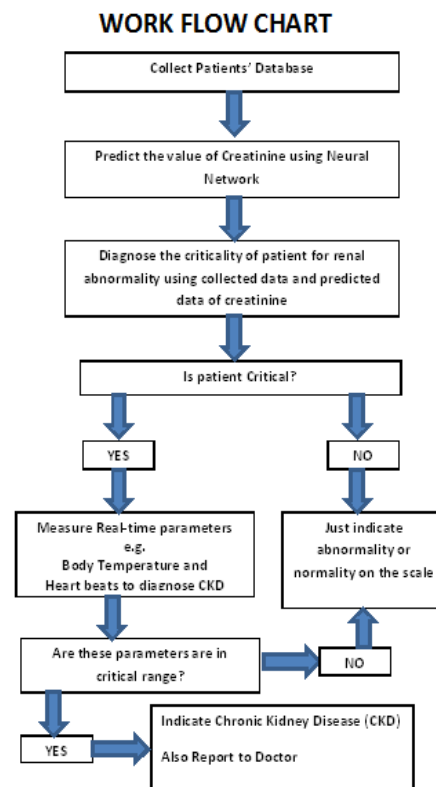

Fig-1: Workflow chart for implementing this novel approach for CKD diagnosis

For Neural Network implementation in NN tool, first we have done classification of values of patients' data based on the values. Based on specific value of the parameter it is assigned the value 1(one), 0 (zero) or 2 (Two).

Parameter	0 Normal	1 Moderate	2 Critical
Blood Glucose	< 150	150 – 250	> 250
BMI	<18.5 Under Weight	18.6 – 25.5 Moderate	>25.5 Over Weight
Blood Pressure (Diastolic)	70 – 90	91 – 100	>100 OR < 70

Table-1: Parameter Classification based on values [3]

Above parameters of 550 patients are used as input data and training data set. Target data set i.e Creatinine value based on Blood Glucose and BMI are considered for all these

patients. Critical BMI and diabetes outcome 1 or 2 will cause Creatinine outcome 1 or 2. In our dataset we have considered formula based classification i.e.

\* $IF(C2 < 150, "0", IF(C2 < 250, "1", IF(C2 > 250, "2")))$  – Blood Glucose Outcome to detect diabetes outcome [ C2 = Blood Glucose value as per our dataset table column]

\* $IF(F2 < 18.5, "0", IF(F2 < 25.5, "1", IF(F2 > 25.5, "2")))$  BMI Outcome [ F2 = BMI value as per our dataset table column]

\* $IF(I2 < 90, "0", IF(I2 < 100, "1", IF(I2 >= 100, "2")))$

Blood Pressure Outcome [ I2= Blood Pressure value as per our dataset column]

\* $IF(AND(E4=1, H4 >= 0), "2", "1")$  Creatinine Outcome [E4 = Creatinine value as per our dataset column] If person is having diabetes outcome positive and BMI level is also greater than 0 then that person is prone to high or moderate creatinine level.

Creatinine is one of the important parameter to diagnose renal abnormality. Creatinine level : less than 1 Normal , between 1 and 2 Moderate and greater than 2 is considered as critical level. Thus we have made 3 important data sets 1) Input data 2) Target Data and 3) Sample Data, which are given to Neural Network using NN Tool of MATLAB.

Thus, an approach is to predict the value of creatinine based on BMI and Diabetes outcome, (which is decided based on value of blood glucose). In diagnosis of renal abnormality fast diagnosis can be helpful for detection of chronic kidney disease.

Therefore prediction of creatinine can be helpful for diagnosis of renal abnormality in its early stage and then once it is detected, then real time monitoring of body temperature and heart beats can be helpful for diagnosis of chronic kidney disease.

### 5. Creating and Training Neural Network

After importing input, data and target files in workspace Neural Network is created and trained. Here we have used Feed Forward Back propagation algorithm of Neural Network. It is the most widely used method for prediction. It uses receding horizon method for sigmoid function.

It implements a gradient descent search through the space of possible network weights and interactively reducing error E between training example target values and network outputs. This algorithm is also having Minimum error and output =  $0.99 * (target) + 0.63$ . Most of the predicted data are very close to target.

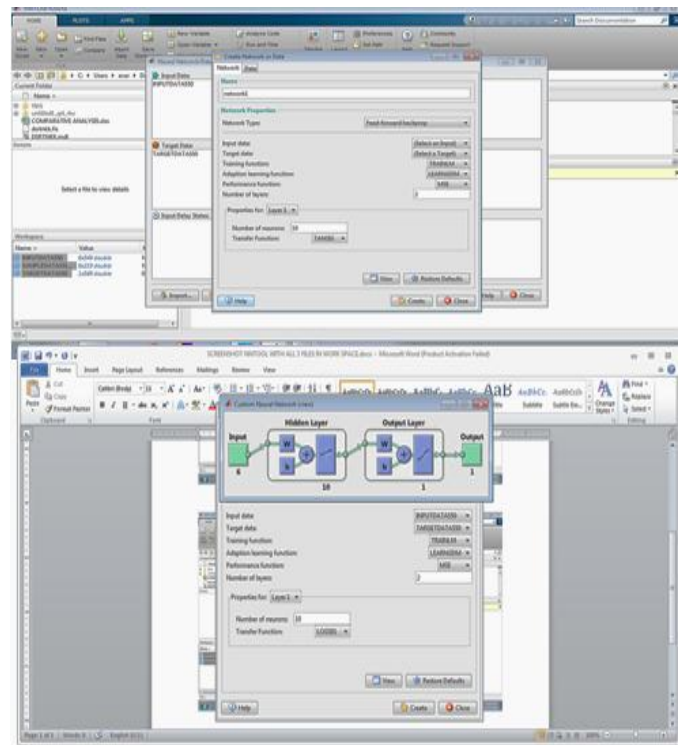

Fig 2: Creating Neural Network and importing data for training of network

Created Network is trained with 550 data set of patients and it is done multiple times to get the best possible outputs for predicted data. [15] [6]

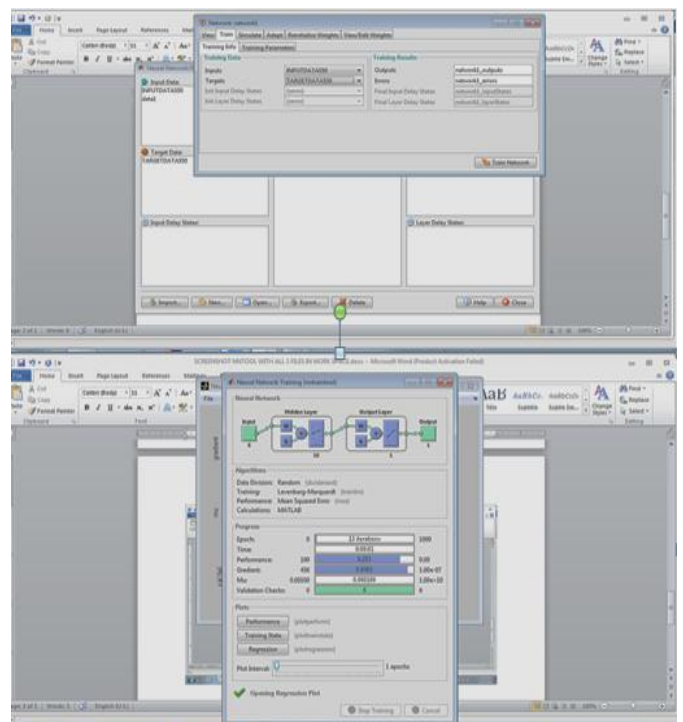

Fig -3: Training of Neural Network

Training of Network is done multiple times to get better results and regression plots are generated using NN tool. After that sample data is fed to network and prediction of creatinine is done for the sample data. All patients' data from 551 to 769 i.e for total 219 patients' data are considered as predicted data of creatinine based on the input values as mentioned in point -5.

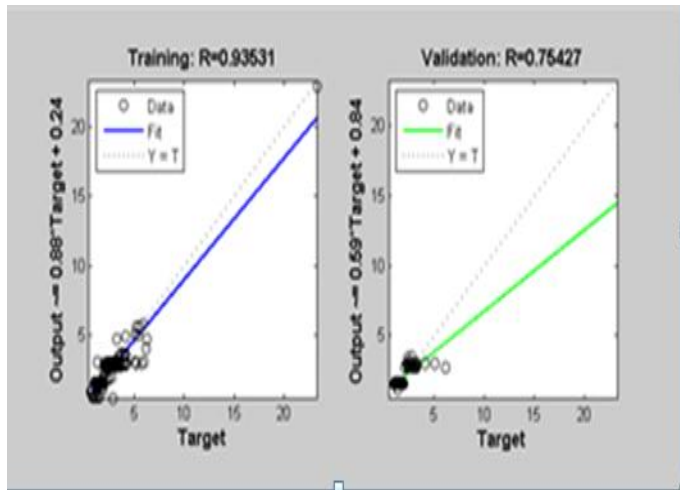

Fig: 4 Regression plot for predicted data

After successful training of network and testing for output of sample data, output file is generated i.e predicted data. These predicted values of creatinine are used for diagnosis of renal abnormality.

Once we get the values of predicted data, then fuzzy logic based diagnosis can be carried out. In Fuzzy logic based diagnosis all data of patients are given as input and based on fuzzy rule bases patient's critical condition is found as normal, moderate or critical. If patient is found critical then real time monitoring of heart beats and body temperature are required for diagnosis of Chronic Kidney Disease (CKD).

Chronic kidney disease (CKD) is a condition characterized by a gradual loss of kidney function over time. If kidney disease gets worse, wastes can build to high levels in blood and makes one feel sick. Hence, Body Temperature, needs to be monitored. Also, kidney disease increases the risk of having heart and blood vessel disease.

Hence, heart beats needs to be monitored. Early detection and treatment can often keep chronic kidney disease from getting worse. When kidney disease progresses, it may eventually lead to kidney failure, which requires dialysis or a kidney transplant to maintain life. (Source: A report on CKD (2017) by National Kidney Foundation.)

Here in the next phase we have done diagnosis based on fuzzy logic. FIS editor MATLAB is used for the diagnosis of renal function abnormality based on the following four parameters. 1) BMI 2) Diabetes Outcome 3) Blood Pressure and 4) Predicted Value of Creatinine.

Based on these four parameters 16 rules are prepared. These rules are prepared for membership functions which are formed for each parameter as normal, moderate or critical. e.g. Blood pressure normal, moderate or critical. And similarly other parameters Creatinine, Blood Glucose and Creatinine as normal, moderate and critical. All these rule bases help in determination [9]

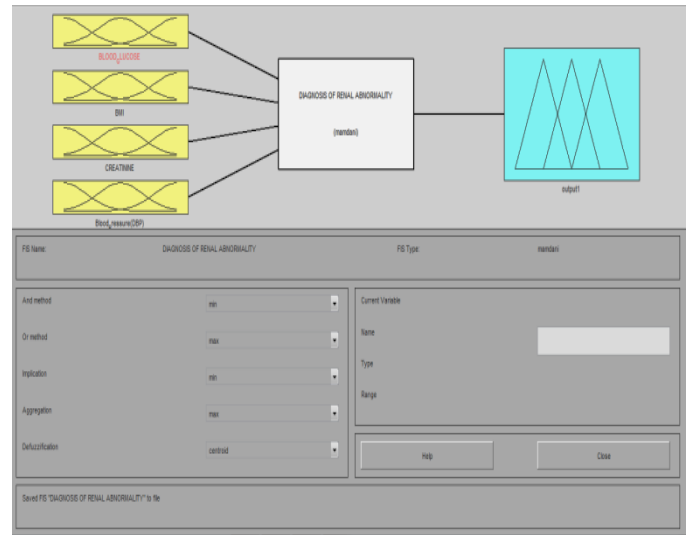

Fig: 5 Diagnosis of Renal abnormality using FIS

Based on variations of pathophysiological parameters, the range of important parameters are determined and then each parameter is evaluated for its variation by plotting it in MATLAB.

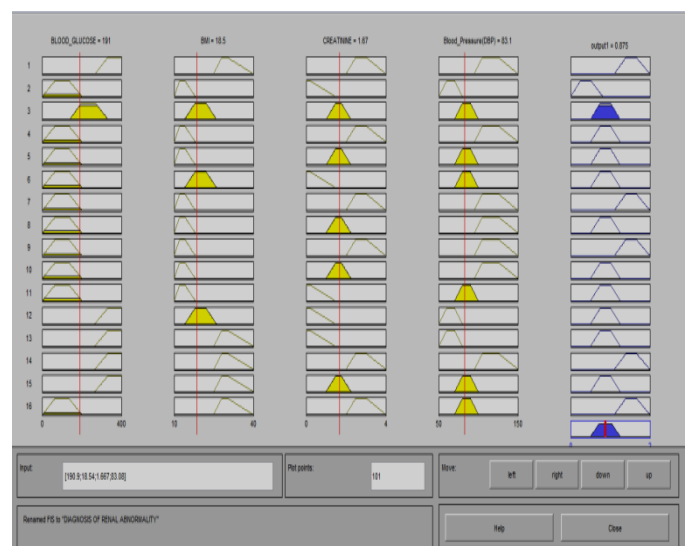

Fig-6 Rules for diagnosis of renal abnormality

Using MATLAB-FIS editor different membership functions are selected and analyzed for specific results i.e parameter as normal, moderate or critical. Finally the state of a patient is

also determined considering the rule bases prepared, considering the state of individual parameters. [15][16].

A comparative study is conducted based on various ranges of parameters and then the shapes of membership functions are determined for fuzzy based diagnosis of renal condition of a patient. Comparative analysis of membership functions having different shapes and ranges helps in proper way for deciding specific shape of membership functions for fuzzy logic based diagnosis.

After such analysis trapezoidal shape is selected for membership functions and related diagnosis is done. Thus in this approach we have used predicted data of neural network for fuzzification along with other three parameters, which are used for diagnosis of the renal disease.

### 6. Experimental work

Based on the predicted data concept we have considered parameters of 40 patients as an experiment. For all these patients Height, Weight (BMI calculated), Blood Glucose, BP and predicted Creatinine are considered for preliminary diagnosis of renal function abnormality.

Here rule bases are prepared to determine the patient's output state i.e Normal. Moderate or Critical. In this work considering 4 parameters we have made 16 rule bases e.g If BMI is critical AND Blood Glucose is critical AND BP is critical AND Creatinine is Critical THEN Patient's abnormality state is Critical. If BMI is critical AND Blood Glucose is Moderate AND BP is moderate AND Creatinine is Critical then Patient's state is Critical etc.

All these rules are implemented for testing purpose using Simulink.

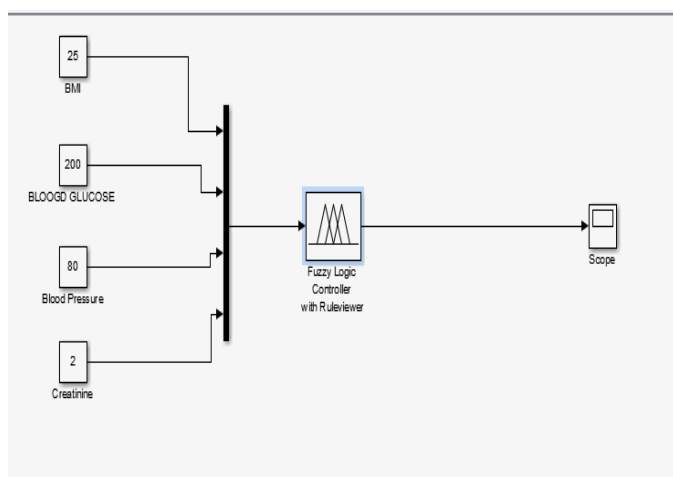

Fig-7 Simulation of rules using Simulink model

For purpose of this work, data has been collected for various patients from laboratory and hospital. Data of 40 patients

are collected for testing purpose Diagnosed data are tested using Bayesian method for accuracy of the system.[2][3].

Testing this system using Bayesian method,

Let a= Number of patients where diagnostic test gives positive result and patient really has a disease, b= Number of patients where the diagnostic test gives a positive result and patient does not have disease, c = number of patients where diagnostic test gives negative result and patient really has disease and d=number of patients where diagnostic test yields a negative result and patient does not have disease. In this case a =26, b=4, c=4, d=6.

Total a+b+c+d=40.

Therefore prevalence of diagnosis =  $\frac{a+c}{a+b+c+d} = (26+4)/40 = 0.75$ . And Sensitivity of diagnosis =  $\frac{a}{a+c}$ ,  $26/30 = 0.87$  Thus the proposed smart system gives an accuracy of 87%.

### 7. Conclusion and future scope of work

Proposed system is designed to use basic vital sign parameters i.e Height & Weight (or BMI), Blood Glucose (Or Diabetes Outcome), Blood Pressure and to predict Creatinine for a patient.

Then these parameters are used to determine abnormality of a patient using Fuzzification and based on simulation it gives 87% accuracy.

System is planned to implement on embedded system platform so that a device or product development approach can be implemented in future. [19]

Further parameters and diagnosis can also be transmitted to doctor for verification using IOT and patients' e records can be maintained for further data mining.

### References:

[1] Guneet Kaur, 2Ajay Sharma, "Predicting Chronic Kidney Disease Using Data Mining Algorithms In Hadoop" International Journal of Advanced Computational Engineering and Networking, ISSN: 2320-2106, Volume-5, Issue-6, Jun-2017

[2] Cristina Elena Turcua, 2 Cornel Octavian Turcua, "Internet of Things as Key Enabler for, Sustainable Healthcare Delivery" Procedia - Social and Behavioral Sciences 73 (2013)251 - 256 The 2nd International Conference on Integrated Information ELSEVIER-2013

[3] 1 Shubhajit Roy Chowdhury, 2 Hiranmay Saha "Development of a FPGA based fuzzy neural network system for early diagnosis of critical health condition of a patient", ELSEVIER- NOV-2009

- [4] Crystin C, Kidney functions and cardiovascular risk factors in primary hypertension: Jaoa Victor Salvado, AnaKarina Franca- Kidney Disease Prevention - Elsevier Journal vol-59-2012.
- [5] 1. Damodaran Vasudev 2. Kanan Vaidyanathan Indian council of Medical Research Ch:25 Research Gate Jan-2017
- [6] Patient Monitoring system based on Internet of Things, Jorge Gomez, Byron Oveido 7th International conference on AResembient system, Network and topologies Elsevier-2016
- [7] S. M. Riazul Ismail<sup>1</sup>, (Member, IEEE), Daehan Kwak<sup>2</sup>, MD. Human Kabir<sup>1</sup>, Mahmud Hossain<sup>3</sup>, and Kyung-Sup Kwak<sup>1</sup>, (Member, IEEE The Internet of Things for Health Care: A Comprehensive Survey-IEEE ACCESS-2015
- [8] 1 Abdur Rahim Mohammad Forkan , 2, Ibrahim Khalil , 3 Mohammed Atiquzzaman "ViSiBiD: A learning model for early discovery and realtime prediction of severe clinical events using vital signs as big data" ELSEVIER-2017
- [9] 1 Himashu Sharma 2 M A Riawi "Prediction of Heart Disease using Machine Learning Algorithms: A Survey" International Journal on Recent and Innovation Trends in Computing and Communication ISSN: 2321-8169 Volume: 5 Issue: 8, 2017
- [10] Andrew Kusiak, Bradley Dixon, Shital Shaha "Predicting survival time for kidney dialysis patients: data mining approach" Computers in Biology and Medicine 35 (2005) 311-327- 2004
- [11] Abhishek, 2 Gour Sundar Mitra Thakur, 3 Dolly Gupta Proposing Efficient Neural Network Training Model for Kidney Stone Diagnosis, International Journal of Computer Science and Information Technologies, Vol. 3 (3) 2013
- [12] Peter Groves; Basel Kayyali, (2013), "The 'big data' revolution in healthcare", McKinsey and Company. Center for US Health System Reform Business Technology Office. E2-2013.04-The-big-data-revolution-in-US-health-care-Accelerating-value-and-innovation
- [13] T., Huang, L., Lan, (2015), "Promises and Challenges of Big Data Computing in Health Sciences", Big Data Research vol.2, PP2- Elsevier 2015
- [14] Dr. S. Vijayarani<sup>1</sup>, r.S.Dhayanand<sup>2</sup> Kidney Disease prediction using SVM and ANN Algorithms International Journal of Computing and Business Research (IJCBR), Volume 6 Issue 2 March 2015
- [15] Development of an FPGA based Smart Diagnostic system for spirometric data processing applications, Shubhajit Roy Chowdhury, Dipankar Chakrabarti, Hiranmay Saha, International Journal on Smart Sensing and Intelligent Systems, VOL. 1, NO. 4, December 2008
- [16] Steve G. Peters, James D. Buntrock, (2014), "Big Data and the Electronic Health Record", Ambulatory Care Manage, Vol. 37, No. 3, pp. 206-210
- [17] R. Weil, (2014), "Big Data in Health: A New Era For Research and Patient Care Alan R. Weil", Health Affairs, Vol.33, N° 7, pp 1110.
- [18] Basma Boukenze<sup>1</sup>, Hajar Mousannif<sup>2</sup> and Abdelkrim Haqiq Performance of Data Mining Techniques to Predict in Healthcare Casr Study: Chronic Kidney Failure Disease
- [19] Divya Saxena, Vaskar Raychoudhury, Membes, IEEE, Design and Verification of NDN-Based Safety-Critical Application: A Casetudy With Smart Healthcare IEEE-2017