

PORTABLE DEVICE FOR REAL-TIME TRACKING WITH EMERGENCY ALERT FOR WOMEN SAFETY

Akash Talebailkar¹, Aniruddha Deshpande², Akshay Yadur³

^{1,2,3} Student, Dept. of Electronics and Communication Engineering, KLS Gogte Institute of Technology, Belagavi, Karnataka, India

Abstract - Today is an era of women empowerment, wherein a woman has shown her capabilities in every field. But there are many incidents which try to degrade their morale and confidence. So in today's world women's safety is a major issue of concern. Women are subjected to unethical physical harassment. So to tackle this problem many mobile apps and electronics devices are available but the devices are so bulky with a slow response time that they are not feasible to carry everywhere easily. So here we present an idea to design a device that is so small that it can be worn as a ring or it can be attached to the clothing or it can be worn as a necklace. Using this device we will be able to send emergency alerts and the location of the device to family members with just one click. The design is so simple that any common people will be able to handle it.

Key Words: Arduino programming, ESP8266 module, Blynk environment, IFTTT environment

1. INTRODUCTION

Women's safety in India has become a concerning issue since 2012 with the crime against women growing at an alarming rate. According to the National Crime Records Bureau of India (NCRB) reported incidents of crime against women increased by 6.4% during the year 2012, and a crime against women is committed every three minutes [1]. So to solve this problem many mobile apps and electronic devices are available, but using mobile apps in that situation is not feasible and the electronics products are so bulky that it is very difficult to handle. The purpose of this project is to design a safety device for women which is easy to handle and compact in size such that it can be worn as a ring or as a necklace and carry anywhere easily without anybody's notice.

Whenever a woman finds herself in trouble, then a switch has to be pressed by her manually, which activates the microcontroller and sends an emergency message to the pre-decided cell phone numbers (typically the family members) along with the location.

Thinking about the concern of women in mind the developers have come up with many mobile apps, so when women find herself in trouble, she needs to click the button in the app which sends emergency alerts to police control. But when a girl is in trouble, it is very difficult to take the phone and press the button.

2. Existing System

Concerned about the safety of the women many developers have come up with many hardware devices and software applications. However, the hardware implementations are quite expensive and many women may not be able to afford it. Many android applications are also launched to help women in difficult situations. These applications need a single click to start their task. However, in many situations, the girl might not be able to pick the smartphone and press the required button. These concerns motivated us to develop an efficiently portable and easy to use device that serves the purpose of protecting the women very efficiently.

3. Prototype Description

The main aim of our system is to minimize the work needed to be done or the actions to be taken by a woman to request help. This proves to be extremely important and useful as the requests can be generated within a blink of an eye and the actions can be undertaken at a rapid pace.

3.1 Design and Development

3.1.1 Hardware Used

1. ESP8266 Wi-Fi module
2. Slider switch
3. Push-button
4. LiPo battery

3.1.2 Hardware Specifications

(1) ESP8266 Wi-Fi module

An ESP8266 WIFI Module is a System on a Chip incorporating TCP/IP which gives the microcontroller access to our Wi-Fi network. This ESP8266 is an effective platform for communication to be carried out through the internet.[2]The ESP8266 module is pre-programmed with an AT command firmware. The module can be integrated with the sensors by making use of its 2 GPIO pins and can be used for many applications.

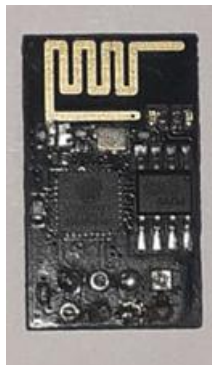

(2) Slider Switch

A slider switch is a mechanical switch that incorporates a slider that moves from the open(off) position to the closed(on) position. It is a bistable two-position switch which helps us to control and channelize the current flow in the circuit. This allows us to establish control over the current flow in a circuit without the need to cut or trim the wire manually. With the help of a slider, one can further connect many circuits to an existing one and can be connected optionally according to the need of the application.



(3) Push Button

A push-button is a type of switch with a mechanism that either turns off or turns on the device. The body of a button is usually built by either metal or plastic and may be constructed in a variety of shapes. This button has many electronic applications such as in calculators, feature phones, etc.[2]



(4) LiPo battery

A lithium-ion polymer battery is a rechargeable battery of lithium-ion that uses polymer electrolyte instead of a liquid electrolyte. Providing higher specific energy than its other lithium-based battery counterparts is one of the main advantages of this battery. It is useful in applications where the weight of the battery is a critical aspect of the device like smartphones.[3]

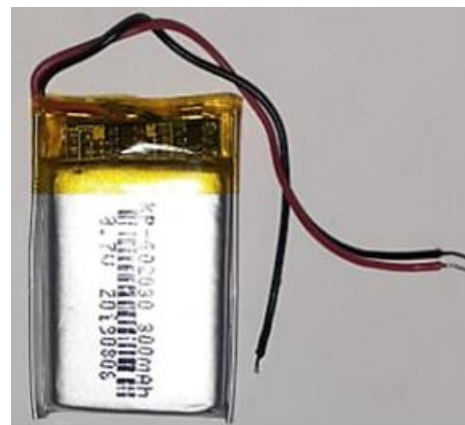

3.1.3 Software Environments Incorporated

- A. Blynk Environment
- B. IFTTT Environment
- C. Arduino Programming

A Blynk Environment

This is an efficient platform that allows us to build, run, monitor the hardware projects from the smartphone. This app is mainly used for operations/tasks which are to be performed through the internet. This app also can display data obtained from the sensors.[4]

There are three major elements involved in the platform mainly:

Blynk app: This allows us to create interfaces for controlling and operating our projects or the hardware circuit.

Blynk server: This is an essential part that enables us to establish communication between our smartphone and hardware.

Blynk libraries: It enables us to set up communication with the server and process all the incoming and outgoing commands

B. IFTTT Environment

IFTTT abbreviates to “If This Then That”. It is a platform that directly communicates between different apps, web applications, and services, devices to trigger user-specific actions through Applets. This platform helps us to automatize our lives in a very simple and efficient way.

For example, if we want to wake up at 6 AM then we can set up a relation like if its 6 AM then turn on our lights. Another example could be to change the lighting conditions of the room every time the song changes on your phone.

IFTTT has a widget called Webhook which takes a request and performs tasks accordingly. Webhooks are user-defined callbacks that are triggered by specific events. A webhook is a method or a channel for an app to provide other applications with some real-time information.

C. Arduino Programming

The Arduino is an open-source hardware and software company that designs and manufactures microcontrollers for building digital devices. The software used to program the ESP8266 module used in this prototype is the Arduino Integrated Development Environment (IDE). This IDE provides a smooth and efficient platform for programming different Arduino boards. The Arduino programming language is based on a simple hardware programming language called processing.

3. Circuit Diagram

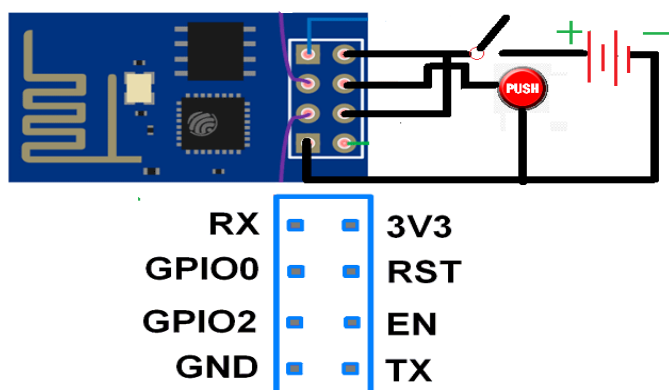

Figure 1: Circuit diagram of the prototype

4. Working of the circuit

Here the ESP8266 module acts as a client and whenever the slider switch is turned by a woman who is need of help the ESP8266 connects to the Wi-Fi network and sends a request to the IFTTT server and the IFTTT server processes the request and performs the specific task which in this case is to send a request for "Help" message to the predetermined mobile phone.

Then the ESP8266 connects to the central Blynk server. This can be considered as a chat between two people. Both the ESP8266 and the Blynk app connect to a central Blynk server and with the help of an authorization token a communication channel is opened which allows them to talk to each other through a push system which in turn implies that the communication channel is bidirectional and asynchronous. Here the Blynk app sends the location of the network (to which the ESP8266 is connected) to the Blynk server and the Blynk server sends the location of the women to the predetermined phone number.

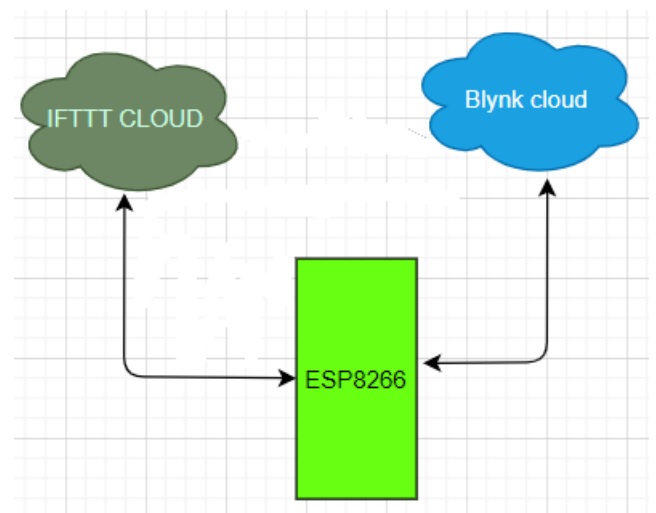

Figure 2: Basic understanding of the process involved

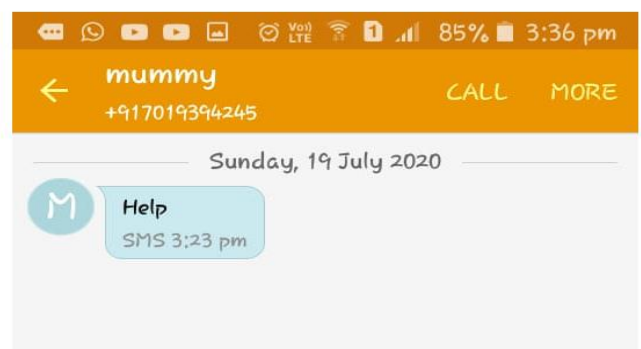

Figure 3: A message received when button pressed by women

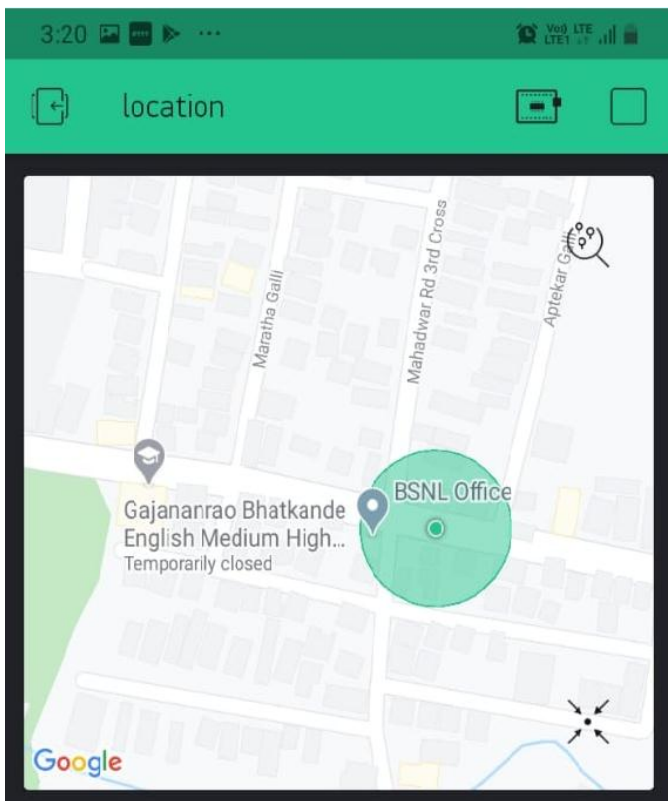

Figure 4: Location as shown by Blynk app

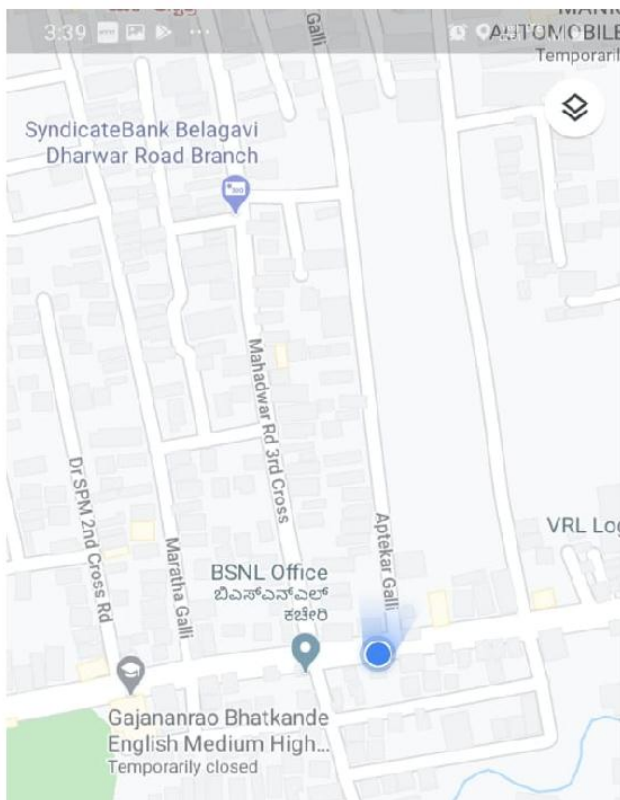

Figure 5: Location as shown by Google Maps

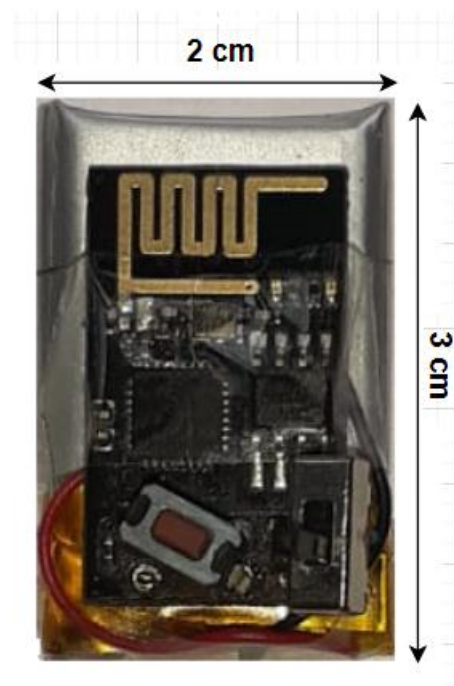

Figure 6: Basic prototype

5. Conclusions

This device has been designed to protect women against increasing crimes against them and let them feel secure in this society. The main aim of this device is to simplify the circuits as compared to the previously existing ones and minimize the work that has to be performed by women in emergencies which in this device is just pressing a button. This device is also designed to reduce the time required to generate a request. This system was designed after reference to the already implemented system and measures have been taken to reduce the response time needed.

Whenever a woman presses the emergency button initially the “Help” message is sent to the predetermined number as shown in figure 3.

Figure 4 indicates that the dimensions of the prototype are extremely small which supports the fact that it is easily portable and handy.

From figures 5 and 6 we can see that the location is shown in the Blynk app and the location shown in Google maps are closely resembling each other which indicates that there is high precision in tracing the location of the women who are need of help.

6. References

- [1] en.wikipedia.org
- [2] www.sgbotic.com
- [3] en.wikipedia.org/wiki/Lithium_polymer_battery
- [4] Docs.blynk.cc
- [5] www.globalspec.com
- [6] TOUCH ME NOT-A Women Safety Device Jismi Thomas¹, Maneesha KJ², Nambissan Shruthi Vijayan³, Prof. Divya R⁴.
- [7] Madhura Mahajan¹, KTV Reddy², Manita Rajput "Design and Implementation of a Rescue System for Safety of Women" in "IEEE WiSPNET 2016 conference"

BIOGRAPHIES

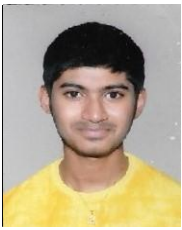
**Akash Talebailkar**

3rd Year Student,
KLS Gogte Institute of Technology
Belagavi, Karnataka, India.

**Aniruddha Deshpande**

3rd Year Student,
KLS Gogte Institute of Technology
Belagavi, Karnataka, India.

**Akshay Yadur**

3rd Year Student,
KLS Gogte Institute of Technology
Belagavi, Karnataka, India.