

Design and Analysis of Rear Upright of a Baja ATV

Suresh A¹, Barath Yogeshwaran K², Ganesh M L³

¹Faculty, Department of Mechanical Engineering, Chennai Institute of Technology, Chennai, India

²Student, Department of Mechanical Engineering, Chennai Institute of Technology, Chennai, Tamil Nadu, India

³Student, Department of Mechanical Engineering, GKM College of Engineering and Technology, Chennai, Tamil Nadu, India

Abstract -The Society of Automotive Engineers helps to enhance the skills of upcoming engineers by conducting various live events in industrial standards. The ATV manufactured must withstand the extreme conditions in race track to achieve it the rear upright plays a vital role. This journal paper provides an idea about designing and analyzing the rear upright which withstands 7G force on dynamic condition and 730N during the static condition. The 3D model of the rear upright is designed using CATIA V5 with reference to the coordinates from the Lotus Shark software and analyzed in ANSYS to understand the behavior of rear upright during a real-time performance.

Key Words: Rear Upright, Rear Upright, FEA analysis, Upright, Baja ATV

1. INTRODUCTION

The Society of Automotive Engineers eminent as SAE international. SAE aims to enhance the skills and knowledge of engineering students in the field of automobile. The Society of Automotive Engineers was formed in 1905 to serve as an umbrella group for the automotive engineers by Henry Ford who is the father of Ford Motor Company and also the vice president of SAE in 1905. The SAE INDIA conducts various industry-based events such as BAJA SAEINDIA, SUPRA SAEINDIA, EFFICYCLE, TRACTOR DESIGN COMPETITION, E-BAJA SAEINDIA, TIFAN, AERODESIGN, HYBRID VEHICLES. These events work as a bridge connecting young engineers and industry.

The components required to build an ATV are roll cage, brakes, transmission system, steering, suspension, and wheels. The mechanical component which is used to connect wheel hub and brakes to the roll cage is called upright commonly known as Knuckle. In simple it is used to connect the rotating wheel to a non-rotating roll cage which is achieved with a help of a bearing attached to the wheel hub.

The upright is of two types according to their position in the ATV, named as front and rear upright. The front upright is attached to the steering of the ATV to steer the vehicle in the desired path whereas the rear wheel must be linear to the vehicle which is achieved by a toe arrester. The design of the rear upright is based on the

type of arm used and the coordinate value of upright obtained from Lotus software. The most commonly used arm is A-arm and H-arm.

2. METHODOLOGY

The basic parameters like wheelbase, track width, etc... are imported in Lotus Shark software and then the coordinates of upright is obtained. Fig 2 shows the suspension analysis carried out in Lotus Shark software. With the obtained coordinate value a basic 3d model is designed using CATIA V5 software. By considering different load factors a final design is modeled. Then the model is analyzed in ANSYS a Computer Aided Engineering software used to simulate real-time performance in a 3d space. The parameters like stress, strain, deformation, are obtained from ANSYS.



Fig-1 Process Methodology

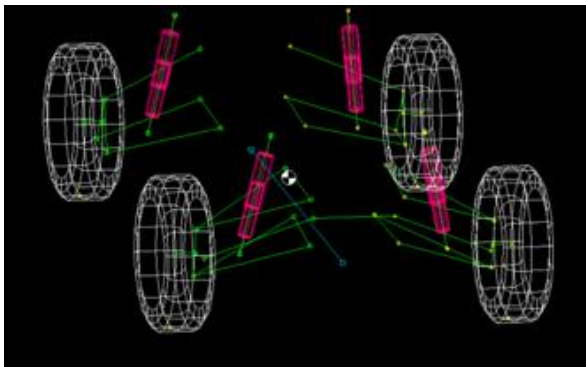

Fig-2 suspension analysis in lotus shark software

3. MATERIAL SELECTION

Material selection is the supreme and primary step of manufacturing. The material selected should have less weight and high strength, affordable price, ease for machining. The material chosen for rear upright is Aluminium 7075 which is easily available it has a high weight to strength ratio, easily machinable, and it is also corrosion-resistant

Table 1: Mechanical Properties of Al 7075

Properties	values
Density	2.81 g/cc
Poisson ratio	0.33
Modulus of elasticity	71.7GPa

4. SOLID MODELLING

The modeling is carried out in CATIA V5 which is owned by Dassault Systemes. A basic 3D model of a rear upright is designed concerning the coordinate values from lotus shark software and considering the loads acting on it in static and running conditions. Design tolerance is also an important factor to be considered. The designed upright must be lightweight, easy to dismantle, and easy to manufacture. Figures 3 and 4 show the front and side view of the rear upright designed. The designed part file is converted to STEP format or IGES format which is the universal format accepted by ANSYS.

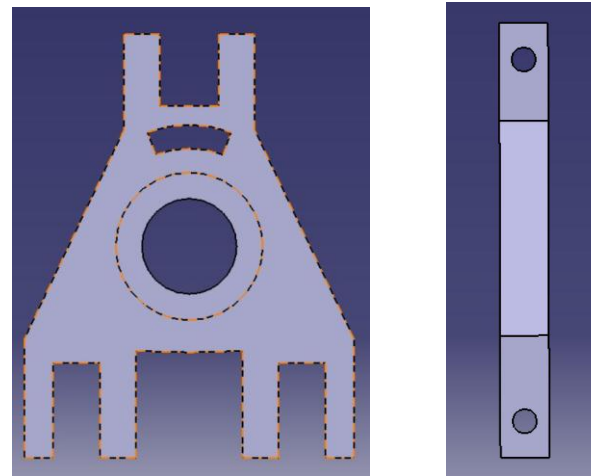

Fig 3- Front view of upright Fig 4- side view of upright

5. ANALYSIS

A series of analysis is done for the rear upright for static condition and dynamic condition. During the static condition, the weight of vehicle is applied on the upright. The vehicle weight's around is 300 Kg which will be equally distributed among the wheels. The load acting on a single upright can be found by $W=m \cdot g$ thus the load acting will be 735.75N. For dynamic conditions, the vehicle is analyzed for 7G force which is the maximum condition a human body can withstand. Thus the load applied for the dynamic condition is 20,601N.

The imported model is meshed so that it will be divided into small elements and analyzed for the above boundary condition to determine the deformation, Von-misses stress, principal strain generated on the rear upright on both conditions

6. Result and discussion

In ANSYS analysis is done for each node individually after solving the results of each and every node is compiled to give the final result

6.1. Total Deformation

The figure 5 and 6 shows the total deformation of the rear upright under static and dynamic conditions for the material aluminium 7075.

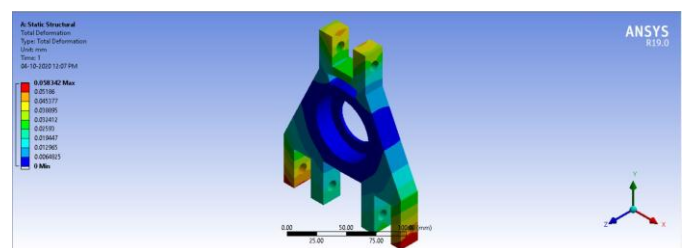

Fig 5 - Total deformation under dynamic condition

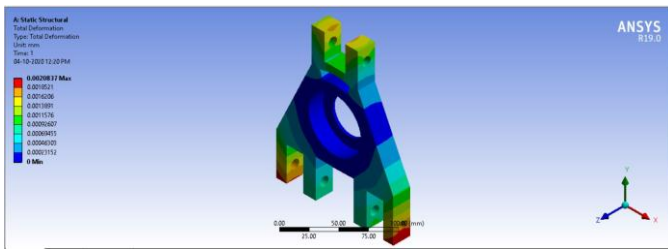

Fig 6 - Total deformation under static condition

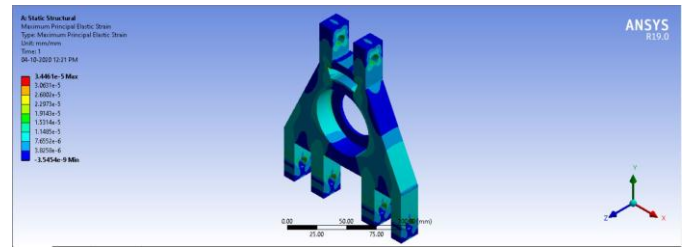

Fig 10 - maximum principal strain under static condition

6.2. Von-misses Stress

The figure 7 and 8 shows the equivalent stress or von-misses stress of rear upright under static and dynamic conditions for the material aluminium 7075.

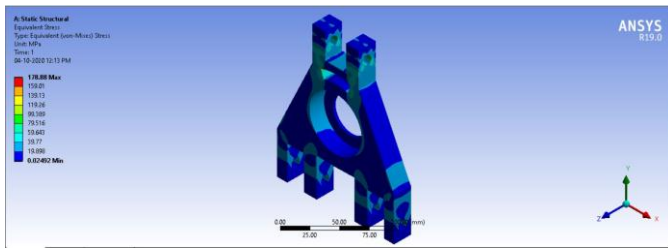

Fig 7 - equivalent stress under dynamic condition

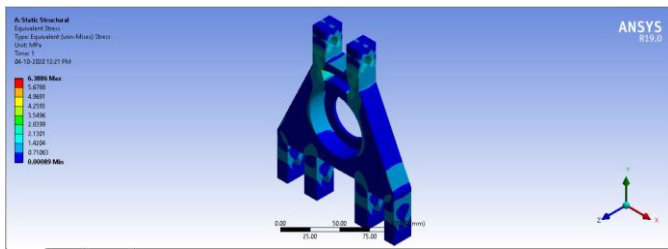

Fig 8 - equivalent stress under static condition

6.3. Maximum principal strain

The figure 9 and 10 shows the maximum principal strain of rear upright under static and dynamic conditions for the material aluminium 7075.

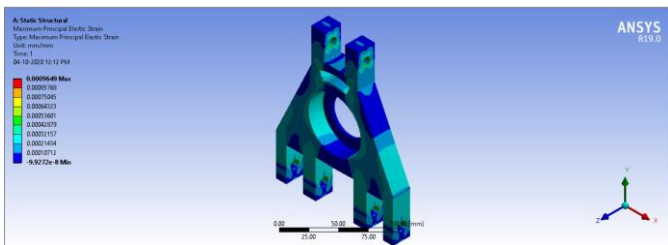

Fig 9 - maximum principal strain under dynamic condition

The table 2 shows the comparison between the static condition and dynamic condition of the rear upright for the material aluminium 7075

Table 2 - Comparison between static and dynamic conditions

Parameters	Static condition	Dynamic condition
Von – Mises Stress	6.3886MPa	178.88MPa
Total Deformation	0.002mm	0.058mm
Maximum Principal Strain	3.4461 e ⁻⁵ mm	9.649 e ⁻⁴ mm

7. CONCLUSIONS

In this paper the rear upright is designed in CATIA V5 and analyzed in ANSYS 19.0 for static and dynamic conditions of an all-terrain vehicle. The material chosen for the rear upright is aluminium 7075. From the above results, the deformation in the rear upright is minimal the stress and strain developed in the rear upright is also minimal. Thus this design of rear upright is suitable for manufacturing and can be used in an all-terrain vehicle

REFERENCES

- [1] C.Aravinth,M.V.RamPradeep,D.Vinoth,Dr.D.Vijayagana pathy "DESIGN AND ANALYSIS OF AL 7075 STEERING Upright COMPONENTS"International Journal of Pure and Applied Mathematics Volume 118 No. 24 2018 ISSN: 1314-3395 (on-line version)
- [2] Sourabh Malviya"DESIGNING THE REAR UPRIGHT OF AN ALLTERRAIN VEHICLE (ATV) THROUGH A PROCESS METHODOLOGY " International Journal of Mechanical Engineering and Technology (IJMET) Volume 10, Issue 08, August 2019, pp. 185-192, Article ID: IJMET_10_08_015
- [3] Yusop, M.S.M , Lazim, M.S.M , Razak, I.H.A , Hashim, M.F"MODEL DEVELOPMENT AND THE SHAPE OPTIMIZATION ANALYSIS OF A REAR Upright FOR RACE CAR "IJRET: International Journal of Research in

Engineering and Technology eISSN: 2319-1163 |
pISSN: 2321-7308

- [4] B. Babu, M. Prabhu, P. Dharmaraj, R. Sampath, "Stress Analysis on Steering Upright of the Automobile Steering System". International Journal of Research in Engineering and Technology, 2014
- [5] S Shaisundaram, V & Loganathan, Karikalan & Vignesh, V & Tamilmani, R & Akash, Mushfiqur. (2018). Design and Analysis of Steering Upright Component For Terrain Vehicle. International Journal of Recent Trends in Engineering and Research. 4. 10.23883/IJRTER.2018.4092.MYRIK

BIOGRAPHIES



Suresh A, Associate professor in mechanical department, Chennai institute of technology with a specialization in machine design.



Barath Yogeshwaran K, pursuing Bachelor degree in the stream of mechanical engineering in Chennai Institute of Technology.



Ganesh M L, pursuing Bachelor degree in the stream of mechanical engineering in GKM College of Engineering and Technology.