

# Automated Irrigation using IoT and Plant Disease Detection using Image Processing and Machine Learning

Pavan Nataraj<sup>1</sup>, Praveen V Mugandamath<sup>2</sup>, Amit Vikram R<sup>3</sup>, Nithin Kumar A<sup>4</sup>

<sup>1,2,3,4</sup>Department of Computer Science and Engineering, Jyothy Institute of Technology, Bangalore, India

\*\*\*

**Abstract:-** India is the largest freshwater user in the world. 86% of water is used for agriculture, 5% for industry and the remaining 8% for domestic purpose. Water plays an important role in plant lifecycle. India is mainly an agricultural country. Irrigation is a vital component of agricultural production. The irrigation system can be classified as either manual or automatic. Compared to manual irrigation, the automated irrigation system can save water and maximize productivity. This method may sometimes lead to over or under irrigation. Manual irrigation takes a lot of time and effort. In automated irrigation water is supplied only when it is required with minimal or no human intervention. With the invent of plant diseases, the yield is affected adversely. Hence it is important to identify the disease at its earliest stages and find a cure to eradicate the disease.

**Key Words:** - Internet Of Things(IoT), Digital Image Processing, KNN algorithm, Otsu Method.

## 1. INTRODUCTION

The main aim of this project was to provide water to the plants or gardening automatically using a microcontroller (Arduino Uno). We can automatically water the plants when we are going on vacation or don't we have to bother my neighbors, Sometimes the neighbors do too much watering and the plants end up dying anyway. There are timer based devices available in India which waters the soil onset interval. Microcontrollers like Arduino are being used to make the system to nearly completely automated. Arduino like any other device is an open source platform which is capable of interacting with the objects by sensing them in the real world. The advantage of this little small electronic device is that it is very easy to learn and Irrigation Station with Supervised Learning using Artificial Intelligence implement. Arduino can receive inputs from many sensors and in turn can control the motors, solenoid valves. The image processing techniques can be used in the plant disease detection. In most of the cases disease symptoms are seen on the leaves, stem and fruit. The plant leaf for the detection of disease is considered which shows the disease symptoms. This paper gives the introduction to image processing technique used for plant disease detection.

### 1.1 TYPES OF IRRIGATION

**Surface Irrigation:** Surface irrigation is the oldest form of irrigation and has been in use for thousands of years. In surface (furrow, flood, or level basin) irrigation systems,

water moves across the surface of an agricultural lands, in an order to wet it and infiltrate into the soil. Surface irrigation can be subdivided into furrow, border strip or basin irrigation. It is often called flood irrigation when the irrigation results in flooding or near flooding of the cultivated land. Historically, this has been the most common method of irrigating agricultural land and still used in most parts of the world.

**Micro Irrigation:** Micro-irrigation, sometimes called localized irrigation, low volume irrigation, or trickle irrigation is a system where water is distributed under low pressure through a piped network, in a pre-determined pattern, and applied as a small discharge to each plant or adjacent to it. Traditional drip irrigation using individual emitters, subsurface drip irrigation (SDI), micro-spray or micro-sprinkler irrigation, and mini-bubbler irrigation all belong to this category of irrigation methods

**Drip irrigation:** Drip (or micro) irrigation, also known as trickle irrigation, functions as its name suggests. In this system waterfalls drop by drop just at the position of roots. Water is delivered at or near the root zone of plants, drop by drop. This method can be the most water-efficient method of irrigation if managed properly, evaporation and runoff are minimized. The field water efficiency of drip irrigation is typically in the range of 80 to 90 percent when managed correctly.

## 2. LITERATURE SURVEY

The author Ms.Sarika Rakshak et al., presents that the Cultivation Management System mansion here is based on cloud. The architecture of system allows user to achieve the above mentioned activities in prearranged time so that farmers can examine their farm field data details from anywhere in between the range. Monitor system mainly consist Hardware module that situated in farm or farm field that has various sensors, devices, ICs for data transformation and transfer. Then Cloud implemented as Software as a Services (SaaS) so that the Android smart phone used as a remote control to make Arduino based automated irrigation system easy-to-use. The system design includes a soil moisture sensor placed in different direction of farm field that provides a voltage signal proportional to the moisture content in the soil which is compared with a predefined threshold value.[1]

The author Mr. Chandan Kumar sahu et al., presents a prototype for automatic controlling a irrigation system. Here prototypes includes sensor node and control node. The sensor node is deployed in irrigation field for sensing soil moisture value and the sensed data is sent to controller node. On receiving sensor value the controller node checks it with required soil moisture value. When soil moisture in irrigation field is not up to the required level then the motor is switched on to irrigate associated agriculture field and alert message is send to registered mobile phone. The experimental results show that the prototype is capable for automatic controlling the experimental results show that the prototype is capable for automatic controlling of irrigation motor based on the feedback of soil moisture sensor. This system is used in a remote area and there are various benefits for the farmers.[2]

The author Yunseop (James) Kim et al., presents An automated closed-loop irrigation system requires three major components: machine conversion, navigation, and mission planning to support the solid communication protocol. This paper developed the machine conversion from a conventional irrigation system to an electronically controllable system for individual control of irrigation sprinklers and formulated the navigation of the irrigation system that was continuously monitored by a differential GPS and wirelessly transferred data to a base station for site-specific irrigation control. This paper also provided extensive details for the wireless communication interface of sensors from in-field sensor stations and for a programmable logic controller from a control station to the computer at a base station. Bluetooth wireless technology used in this paper offered a plug-and-play communication module and saved significant time and expense by using commercially available sensors and controllers equipped with serial communication ports.[3]

The author Sharada Prasanna Mohanty et al., proposed Using Deep Learning for Image-Based Plant Disease Detection Used For In the following method, the training dataset containing 150 -170 images of mulberry plant leaves are analyzed and tested against the test dataset having images of 20 to 30 of the same leaf. The leaf is categorized into diseased and normal leaves. The normal is categorized into 2 species of the same plant namely red mulberry and white mulberry. Using the deep convolutional neural network architecture, the model is trained on images of plant leaves with the goal of classifying both crop species and the presence and identity of disease on images. Across all our experiments, we use three different versions of the dataset. We start with the dataset as it is in color. [4]

The author Sachin D. Khirade et al., proposed Plant Disease Detection Using Image Processing system where the system first acquires the image then image pre-processing is done. Then image segmentation is performed, later feature extraction in image is done which is then followed by

detection and classification of plant disease. The use of KNN methods for classification of disease in plants such as self organizing feature map, back propagation algorithm, SVMs etc. can be efficiently used. From these methods, we can accurately identify and classify various plant diseases using image processing techniques. [5]

### 3. PROPOSED SYSTEM

#### A) Image Acquisition

The images of the plant leaf are captured through the camera. This image is in RGB (Red, Green And Blue) form. Color transformation structure for the RGB leaf image is created, and then, a device-independent color space transformation for the color transformation structure is applied

#### B) Image Pre-processing

To remove noise in image or other object removal, different pre-processing techniques is considered. Image clipping i.e. cropping of the leaf image to get the interested image region. Image smoothing is done using the smoothing filter. Image enhancement is carried out for increasing the contrast. the RGB images into the grey images using color conversion using equation.

$$f(x)=0.2989*R + 0.5870*G + 0.114.*B$$

Then the histogram equalization which distributes the intensities of the images is applied on the image to enhance the plant disease images. The cumulative distribution function is used to distribute intensity values.

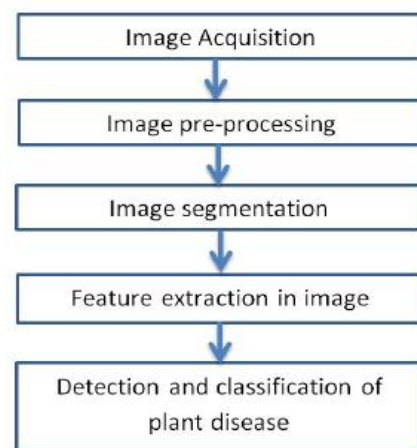

**Fig 1** Basic Steps for Plant disease Detection and Classification

#### C) Image Segmentation

Segmentation means partitioning of image into various part of same features or having some similarity. The segmentation can be done using various methods like otsu' method, k-means clustering, converting RGB image into HIS model etc. In Proposed system data is sensed through sensors then KNN Machine learning algorithm is used for

data Prediction. Sensed data is compare with data set which are stored on past experience, and result is produced. As per the predicted result farmer will take decision from this system for profit gain. As shown in above scenario sensors are deployed in farm which use are to sensed the data related to humidity, temperature, sunlight and wind speed. K Nearest Neighbor algorithm is applied on sensed data to classify and to form cluster. Clusters are then analyses with predefined data set to generate the output. The predicted result shows the whatever diseases can be cause due to particular crop condition.

### 3.1 Technique

K Nearest Neighbor is one of the most powerful learning models. They can have wide range of complex functions which represents multidimensional input-output maps. KNN is also an information processing paradigm that is motivated by way biological nervous system, such as brain. KNN is generally presented as system of interconnected "neurons" which send message to each other. In proposed system the MLP technique is used for data prediction. K Nearest Neighbor are typically difficult to configure and slow to train, but once prepared are very fast in application. With image processing, first we need to pre-process the image data i.e, the training data and then train the system using KNN algorithm to predict whether the plant has a disease or not.

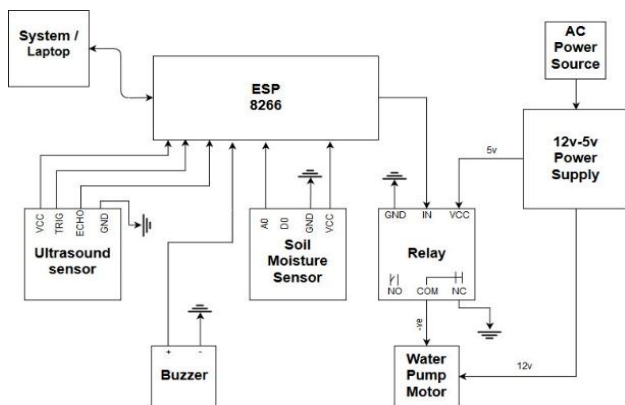

Fig 2 Circuit Diagram

Initially the programmed code is fed into the micro controller i.e. NodeMCU ESP 8266 and compiled to check if there are any errors. If the code is successfully compiled without error it can be uploaded into the ESP. The NodeMCU has an inbuilt in 4mb of flash memory and can store the code. Once the code is uploaded into the ESP whenever it is powered it runs in a loop. So, the code can be uploaded and placed in the developed system and its runs with the power.

The power to all the sensors is given by the microcontroller ESP, and the data that are obtained by the sensors from the surrounding environment is sent to the cloud using Wi-Fi and interface to the cloud is provided to the user through

which user can analyze and observe the data. The time inter between the successive data that are sent to the cloud can be set during the coding using the delay.

According to the requirement of the system to be designed the threshold of the soil moisture is set. When the data sent by the soil moisture sensor reaches the threshold the ubidots send the farmer with an email or message in local language. Also, simultaneously when the data reaches the threshold the water pump is triggered by the microcontroller using a 5v relay. The relay is always in normally connected state where the circuit of the relay is always closed and works when the power flows through it but it has to be triggered.

Ubidots is an IoT deployment platform where the data received from the sensors are analyzed and viewed. Different types of events like message and Email can be sent for some threshold values of the sensor data. The admin or the user uses ubidots via standalone system for viewing, analyzing and also can control sensors. Statistics of these sensor values can also be viewed and can also be monitored.

#### Advantages:-

1. A neural network can perform tasks which linear program cannot.
2. It works even in the presence of noise with good quality output.
3. Saves time and water.
4. water management and efficient use of water.

#### Disadvantages:-

1. Requires a lot of training and cases.
2. Often abused in cases where simpler solution like linear regression would be best.

### 4. RESULT AND DISCUSSION

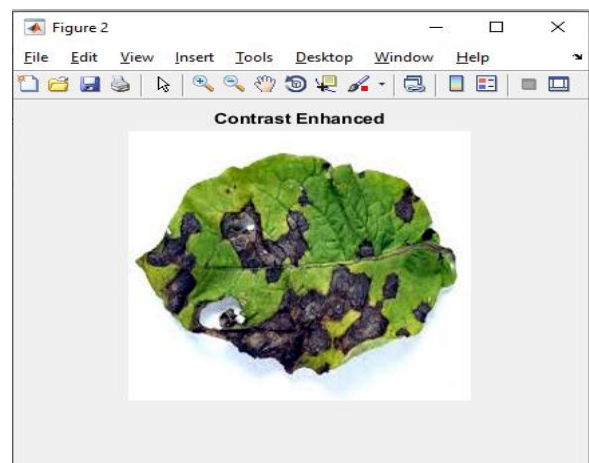

Fig 3 Contrast Enhanced

Contrast of the query image is enhanced to improve the accuracy of the result. Contrast stretching is a simple image enhancement technique that attempts to improve the contrast in an image by 'stretching' the range of intensity values it contains to span a desired range of values

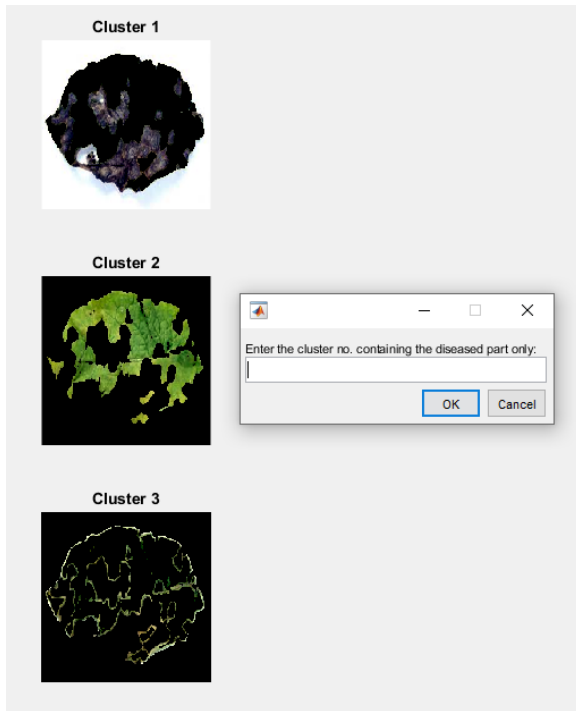

Fig 4 Segmented Images

Used K-Means clustering for segmentation and convert the image from RGB Color Space to L\*a\*b\* Color Space. The L\*a\*b\* space consists of a luminosity layer 'L\*', chromaticity-layer 'a\*' and 'b\*'. All of the color information is in the 'a\*' and 'b\*' layers. Classify the colors in a\*b\* color space using K means clustering. Since the image has 3 colors create 3 clusters. Measure the distance using Euclidean Distance Metric.

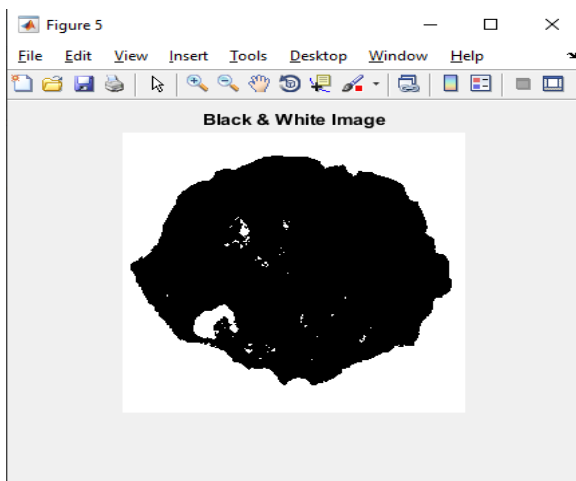

Fig 6 Black and White Image

Then the image the user selects after the segmentation operation, is converted into black and white image format to increase the accuracy.

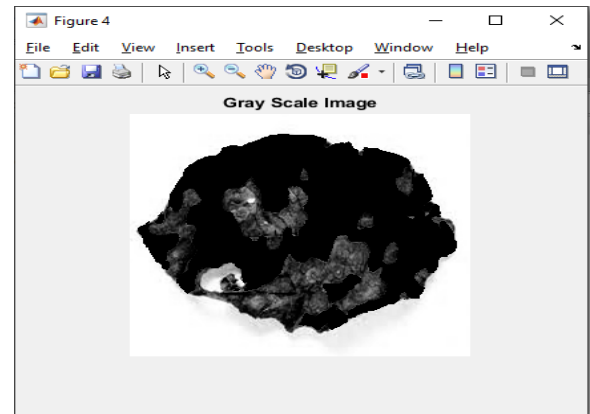

Fig 6 Gray Scale Image

Then the user selected segmented image is then converted into gray scale image to increase the accuracy.



Fig 7 Serial monitor connection to Wi-Fi and sensor values display.

The readings obtained from soil moisture sensor and ultrasonic sensor are shown here in the serial monitor.

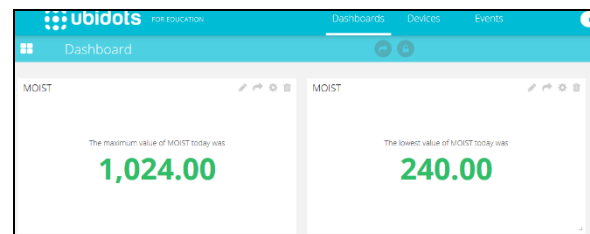
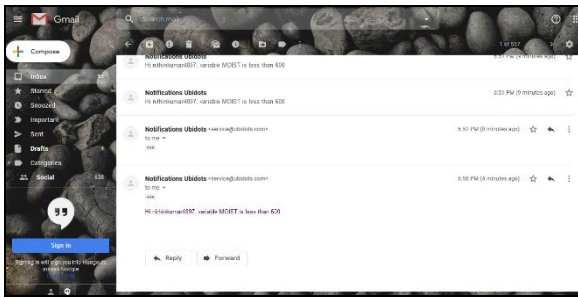

Fig 8 Results in ubidots.

The readings shown in the serial port is being shown in the ubidots server which can be viewed with an internet connection.



**Fig 9** Email notification to user

This is the email that is sent to the farmer or the user from the ubidots server about the status of the farm.

## CONCLUSION

The proposed system provides an agriculture solution using Artificial Neural Network Machine learning algorithm which is used for performing data prediction on data sensed by sensors. Due to the use of IoT devices, the system provides an automated solution for data prediction. The accurate detection and classification of the plant disease is very important for the successful cultivation of crops, and this can be done using image processing.

## ACKNOWLEDGEMENT

The authors express their sincere gratitude to the Principal of Jyothy Institute of Technology, K. Gopalakrishna, Head of the Computer Department, Dr. Prabhanjan, and our Project guide, Mrs. Nikitha S, for giving constant encouragement and support to complete the work.

## REFERENCES

- [1] Sarika Rakshak, Prof. R. W. Deshpande. Automated Irrigation System Based on Arduino Controller Using Sensors.//2017 IEEE.
- [2] Chandan kumar sahu, Pramitee Behera, A Low Cost Smart Irrigation Control System.//2015 IEEE.
- [3] Yunseop (James) Kim, Robert G. Evans and William M. Iversen, Remote Sensing and Control of an Irrigation System Using a Distributed Wireless Sensor Network//IEEE 2008
- [4] Sharada Prasanna Mohanty, David Hughes, Marcel Salathé, Using Deep Learning for Image-Based Plant Disease Detection //IEEE 2018
- [5] Sachin D. Khirade, A. B. Patil, Plant Disease Selection using Image processing//IEEE 2015