

Analytical Study on Response Reduction of High Rise Buildings by Diagrid Construction

Aravind A¹, Sandeep T N²

¹P G Student, Department of Civil Engineering, SCMS School of Engineering and Technology, Kerala, India

²Assistant professor, Department of Civil Engineering, SCMS School of Engineering and Technology, Kerala, India

Abstract - The Diagrid structures are used nowadays in the construction of tall structures due to their effective resistance against lateral forces. When the height of structure increases then the consideration of lateral load is very much important. For that the lateral load resisting system becomes more important than the structural system that resists the gravitational loads. The Diagrid structure takes both the gravity load and lateral loads as axial loads due their inclined configuration Here a tall diagrid structure is modelled with different storey modules and its performance against seismic loading is analysed and compared. The seismic loading is applied in the form of base excitation. The modelling and analysis is done using Finite Element Analysis of Structures [FEAST] software. The data of Bhuj Earthquake is used for applying base excitation. 36 and 60 storey building is used for the analysis and corresponding top storey displacement and frequencies are noted. Also the diagrid pipe cross section is changed and also parametric study on varying pipe diameter is done. From the result it was found that the 4 storey module performed the best against seismic forces and circular pipe is better compared to square hollow section. With the increase in pipe diameter it showed a decrease in top storey displacement.

Key Words: Diagrid structure, Storey module, Lateral loads, Transient analysis, Top storey displacement, Frequency, Optimum storey module

1. INTRODUCTION

Earthquake-resistant structures are structures designed to protect buildings from earthquakes. While no structure can be entirely immune to damage from earthquakes, the goal of earthquake-resistant construction is to erect structures that fare better during seismic activity than their conventional counterparts. According to building codes, earthquake-resistant structures are intended to withstand the largest earthquake of a certain probability that is likely to occur at their location. This means the loss of life should be minimized by preventing collapse of the buildings.

Transient response analysis is the most general method for computing forced dynamic response. The purpose of transient response analysis is to compute the behaviour of a structure subjected to time varying excitation. The transient excitation is explicitly defined in a time domain. All the forces applied to the structure are known at each instant of time. In transient analyses the structural response is

computed at a number of subsequent time instants. In other words, time histories of the structural response to a given input are obtained as a result. The important results obtained from a transient response analysis are displacements, velocities and accelerations of points and forces and stresses in elements.

The lateral loading due to wind and earthquakes is the major factor that causes the design of high rise buildings. These lateral loads are resisted by exterior structural systems or interior structural systems. A diagrid structure is an exterior structural system in which all perimeter vertical columns are eliminated and it consists of only inclined columns on the façade of the building.

In this study the analysis on various diagrid framed models are studied based on the number of stories stacked per module, change in cross section and variation of diagrid member diameter. Transient Response is done for carrying out the analysis.

2. MODELLING OF DIAGRID STRUCTURES

For the analysis, diagrid structures with following properties are taken^[1].

Basic plan dimension: 36 × 36 m

Storey Height : 3.6 m

Number of stories : 36 and 60 nos

Diagrid building models : 2 storey module, 4 storey module, 6 storey module, 12 storey module and Conventional building.

2.1 Material Properties

For the analysis steel members are used. The material properties include modulus of elasticity, Poisson's ratio and mass density. The properties of the members are shown in Table-1.

Table -1: Material properties of steel members

Properties	Steel members
Modulus of elasticity	2e+11 N/m ²
Poisson's ratio	0.3
Mass density	7850 kg/m ³

2.2 Diagrid Models

The plan and elevation of the diagrid buildings are shown in Fig-1 and Fig-2

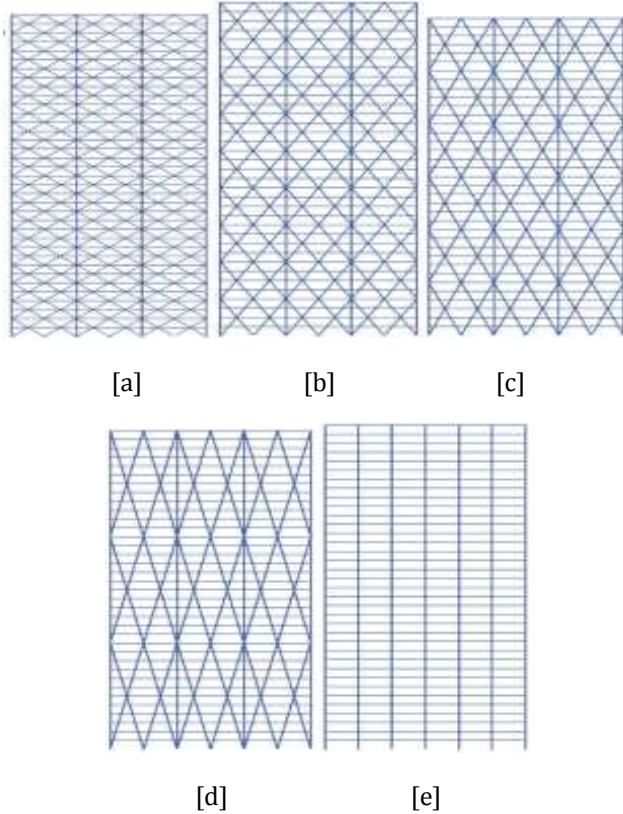

Fig-1 36 storeyed Diagrid models. [a] 2 storey module, [b] 4storey module, [c] 6storey module, [d] 12 storey module, [e] Conventional building

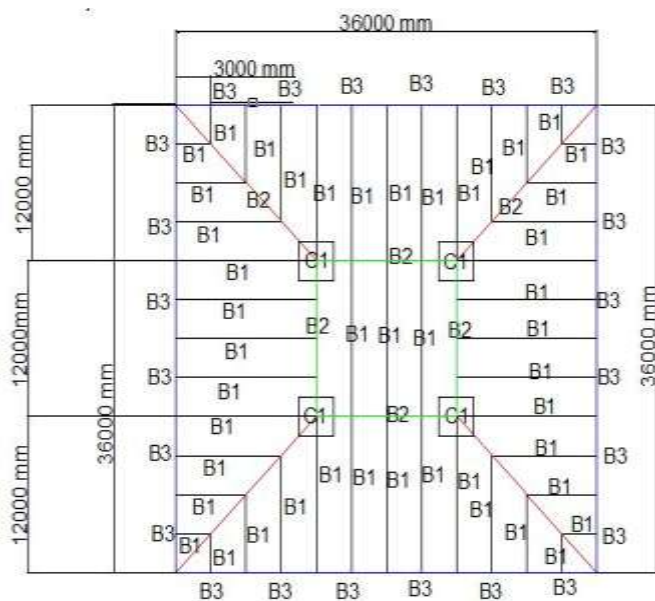

Fig-2 Plan of the model

2.2 Earthquake data

For the analysis the earthquake time histories of Bhuj earthquake is taken from COSMOS virtual data center [11]. The earthquake time histories consists of Time vs Acceleration graph as shown in Fig-1. The input data is applied for 50 seconds.

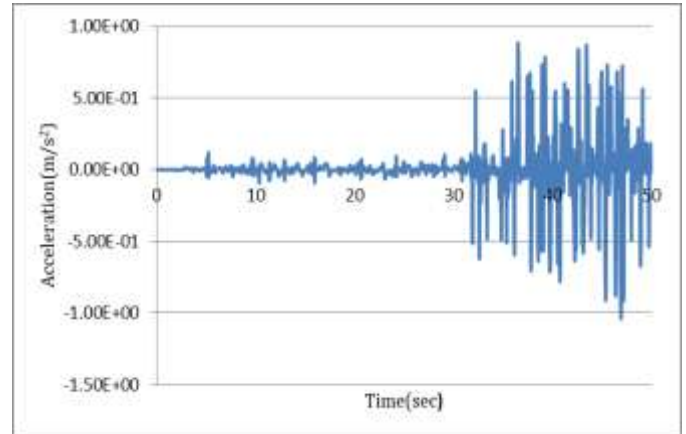

Fig-3 Bhuj Earthquake time histories

2.2 Member Dimensions

The member dimensions for the 36 storey and 60 storey diagrid models are shown in Table-2

Table -2: Member sizes for diagrid structure^[1]

Storey	Diagonal Columns	Interior Columns	Beams (Same for all storeys)
36 Storey	375mm pipe section with 12mm thickness (from 19 th to 36 th storey)	1500×1500mm	B1 & B3 = ISMB 550 B2= ISWB 600
60 Storey	450mm pipe section with 25mm thickness (from 1 st to 18 th storey)	1800×1800mm	

3. ANALYSIS ON DIAGRID STRUCTURE

3.1 Transient Response Analysis on 36 and 60 storeyed diagrid structure

For the analysis of structure transient response method is adopted. 36 storeyed conventional building and diagrid buildings with 2 storey, 4 storey, 6 storey and 12 storey are taken for the analysis. The force is applied at the base and the top storey displacement is calculated for the structure. For carrying out the analysis Finite Element Analysis Of Structures (FEAST) software is used. The Time vs Acceleration (Fig-2) graph data is taken and force is calculated for the application of the earthquake force. The force is calculated using the equation :

$$F = mA$$

where,

F – Force

m – Mass of the structure

A – Acceleration

The force is applied at the base node of the structure which is connected to the supports of structure by rigid links. The boundary condition is applied for the base node by restricting X,Y and Z direction rotations and Y and Z translations while X direction translation is made free as shown in Fig-4.

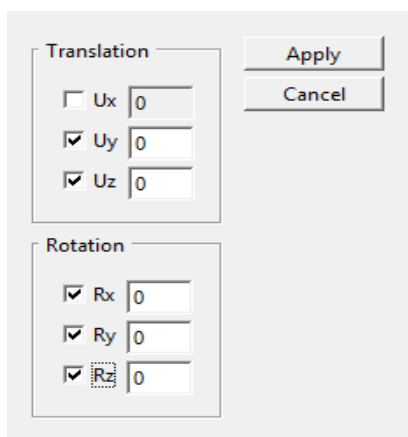

Fig-3 Boundary Conditions

Also a damping of 5% is provided for the structure. After applying the boundary conditions the force is applied in the X-direction. Then the transient response analysis is done for the structure. The topmost node is selected for the analysis for calculating the top storey displacement. The top storey displacement and frequency is obtained for the structures. Similar to that of the 36 storeyed diagrid building 60 storeyed diagrid building is also analysed.

3.2 Comparitive analysis on circular section diagonal member and square section diagonal member

A comparative analysis on the performance of diagrid structure when the diagonal column member of the structure is changed from circular section to square section is done. The member size for the square section is adopted by matching and optimising the section modulus for the circular and square sections. The members are shown in Fig 4. Members with same section modulus possess same strength.

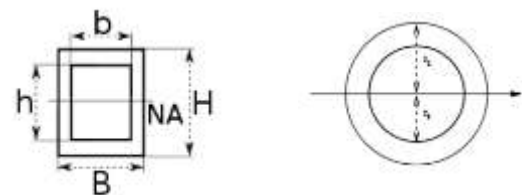

Fig-4 Member Sections

The section modulus for circular section is :

$$S = \frac{\pi(r_2^4 - r_1^4)}{4r_2} = \frac{\pi(d_2^4 - d_1^4)}{32d_2}$$

Also the section modulus for the square section is :

$$S = \frac{BH^2}{6} - \frac{bh^3}{6H}$$

From these equations the square hollow section diagrid member size is found out by trial and error to match the section modulus of circular pipe. The obtained square diagonal member section size is tabulated in Table-3.

Table- 3: Square Section diagonal member sizes

Diagonal Columns	Interior Columns	Beams
287mm Hollow section with 12mm thickness(from 19 th to 36 th storey)	1500×1500mm	B1 & B3 = ISMB 550
344 mm Hollow section with 25mm thickness(from 1 st to 18 th storey)		B2= ISWB 600

Similar to that of the 36 storey circular section diagonal member transient response analysis is done for the square section diagonal member structure and the top storey displacement and frequency is calculated.

3.3 Response of structure with varying pipe diameter

The 60 storeyed diagrid structure with circular section is taken for the study. The diagonal column pipe diameter is increased by 2mm for the 750mm pipe and the following pipes with diameter of 752mm, 754mm and 756mm having 25mm thickness is studied. The response of the structure with the following pipe diameter is found out using the transient response analysis.

4. RESULTS AND DISCUSSIONS

From the transient response analysis done on the structures the following results have been obtained.

4.1 Response of 36 and 60 storeyed diagrid structure.

On carrying out the transient response analysis on the 36 storeyed building it was found that compared to the normal conventional building with vertical columns the diagrid member showed better resistance against earthquakes. Based on the obtained result graph is plotted for the top storey displacement and frequency as shown in Fig 5 and Fig 6.

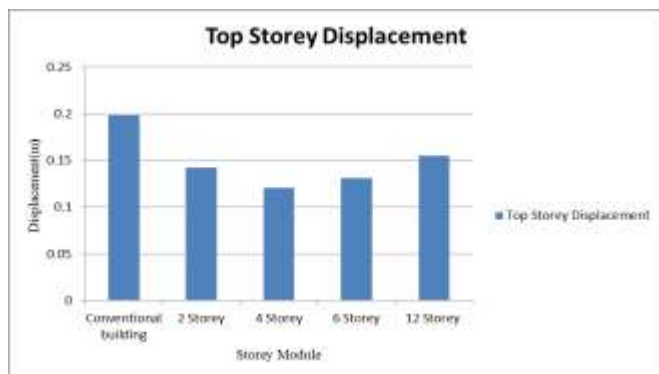

Fig-5 Top Storey displacement of 36 storeyed diagrid structure

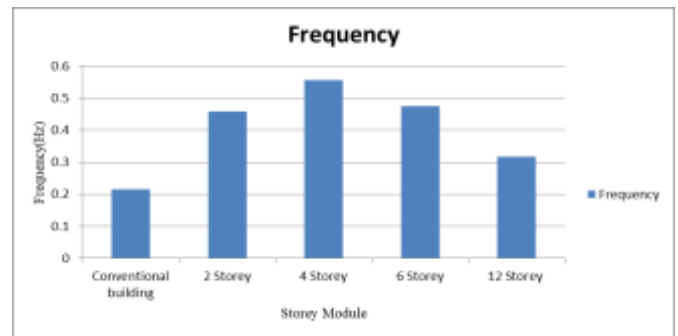

Fig-6 Frequency of 36 storeyed diagrid structure

The top storey displacement of conventional building was the highest with 0.1985m and for the diagrid structure with 4 storey module shows least displacement of 0.1206m followed by 6 storey (0.1314m), 2 storey(0.1426m) and 12 storey(0.1547m) modules. The least frequency was also shown by conventional building with 0.214448Hz and maximum by 4 storey diagrid module with 0.555803Hz indicating that the 4 storey module possess better resistance against seismic action. Also from the displacement and frequency results for the 36 storeyed diagrid building 4 storey module can be taken as the optimum, since it shows the least top storey displacement.

Similarly on conducting the analysis on 60 storeyed diagrid structure the result obtained is shown in Fig-7 and Fig-8. From the results it was found that, for the 60 storeyed diagrid structure also the least top storey displacement was shown by the 4 storey module with 0.0959m and maximum frequency of 0.295706Hz followed by 6 storey(0.1502m), 12 storey(0.1609m) and 2 storey module(0.2589m). From these results it can be confirmed that the 4 storey module is the optimum storey module showing the best performance against earthquake.



Fig-7 Top storey displacement of 60 storeyed diagrid structure

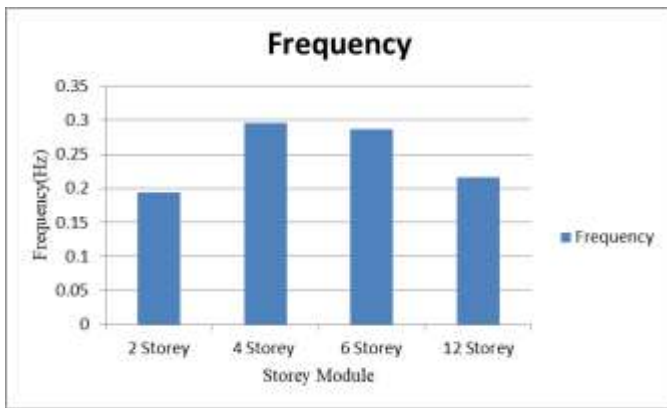

Fig-8 Frequency of 60 storey diagrid structure

4.2 Result of circular and square diagrid structure

The comparative result of diagrid structure having diagonal member as circular section and square section is shown in Fig-9.

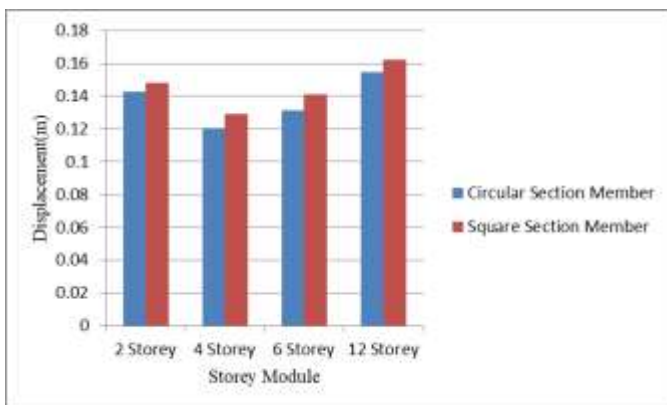

Fig-9 Comparison of top storey displacement for circular and square section diagonal member

From the results it was found that the circular section possess better resistance against earthquake and shows the lower top storey displacement. On comparing the top storey displacements in the case of 4 storey module of both the square and circular section members there is 7% increase in top storey displacement when circular section is replaced by square section. Square member showed a displacement of 0.1289m while the circular section has only 0.0959m And hence for the diagrid structure the circular section diagonal member is better compared to square section.

4.2 Top Storey Displacement with varying pipe diameter.

On carrying out analysis on diagrid structure with varying pipe diameters the following data is obtained as plotted in Fig-11. The member with 750mm pipe diameter showed a displacement of 0.0959m, 752mm(0.0945m),754mm

(0.0928m) and 756mm(0.0913m). From the result it was found that with every 2mm increase in pipe diameter there is a 2% decrease in top storey displacement. So as the pipe diameter increases the top storey displacement decreases.



Fig-10 Top storey displacement with variation in pipe diameter.

CONCLUSIONS

Based on the results obtained the following conclusions has been made :

- The diagrid member is effective in reducing the response of structure during ground motions.
- There is a reduction of 40% top storey displacement when the conventional vertical columns are replaced by diagrid members.
- The circular pipe shows 7% more resistance against ground motion than diagonal member with square section. So circular diagonal member is having better resistance against seismic action.
- The parametric study by changing the pipe diameter shows that with the increasing pipe diameter the top storey displacement is reducing. There is 2% reduction in top storey displacement with every 2mm increase in pipe diameter.

REFERENCES

- [1] **Khushbu Jania, Paresh V. Patelb** (2013) Analysis and Design of Diagrid Structural System for High Rise Steel Buildings, *Procedia Engineering*, Vol 51, pp 92-100.
- [2] **Chengqing Liu, Kaiqiang, Xiaodan Wei, Weixing Shi, Ying Zhou, Guangjie He** (2017) Shaking Table Test and Time-history Analysis of High-rise Diagrid Tube Structure, *Periodica Polytechnica Civil Engineering*, Vol 61, pp 300-312
- [3] **Mohammed Abdul Rafey and M. A. Azeem** (2018) Comparative Analysis of a Diagrid Structure and a

Conventional Structure with Chevron Bracing, *International Journal of Applied Engineering Research*, Vol 13, pp 12311-12317

- [4] **Nishith B. Panchal¹, Vinubhai R. Patel** (2014) Diagrid structural system: strategies to reduce lateral forces on high-rise buildings, *International Journal of Research in Engineering and Technology*, Vol 3, pp 601-6012
- [5] **Arpitha L M, Sahana T S, Siddu Karthik C S** (2016) Comparative Study of Diagrid Structures over Braced tube Structures, *International Journal of Innovative Research in Science Engineering and Technology*, Vol 5, pp 55-63
- [6] **Dhaval N. Sorathiya, Jasmin Gadhiya** (2017) Review on behaviour of Diagrid Structural System in High-Rise Building, *Journal for Research*, Vol 2, pp 46-56
- [7] **Shubhangi V. Pawar, M. S. Kakamare,** (2017) Earthquake and Wind Analysis of Diagrid Structure, *International Journal for Research in Applied Science & Engineering Technology*, Vol 5, pp 247-256
- [8] **Dianfeng Zhao and Kevin K. F. Wong** (2006) New Approach for Seismic Nonlinear Analysis of Inelastic Framed Structures, *American Society of Civil Engineers*, Vol 7, pp 25-35
- [9] **Yogeesh H.S, V. Devaraj** (2018) A Seismic Study on Diagrid Structure, *International Journal for Research in Applied Science & Engineering Technology*, Vol 6, pp 120-136
- [10] **Gurpreet Singh, Akshat** (2018) Dynamic analysis of diagrid structural system in high rise steel buildings, *International Journal of Civil Engineering and Technology*, Vol 9, pp 71-79
- [11] **R. Archuleta, J. Steidl, and M. Squibb** (2004) The COSMOS Virtual Data Center, *13th World Conference on Earthquake Engineering*, Paper No. 1566.