

Simulation of Energization and De-Energization of Capacitor Banks and Mitigation of Transient Overvoltages

Dr. T. Murali Mohan¹, T. Ramya Durga²

¹Dr. T. Murali Mohan, Associative Professor, Electrical and Electronics Engineering & Jntuk University of College, Kakinada & India

²T. Ramya Durga, M.Tech Student, Electrical and Electronics Engineering & Jntuk University of College, Kakinada & India,

Abstract - This paper presents the generation of transient overvoltages associated with switching operations of capacitor banks in distribution systems. Naturally, the nature of the transient is important as it adversely affect the insulation of the system when it is steep fronted. Among various sources for transients, energization and de-energization of capacitor banks are very important situations where the transient peaks are significant both in voltage and as well as current. In order to estimate the characteristics of the transients, a simulation study has been carried out on a 22kV distribution system. Besides the simulation for a generation of transients, some of the reduction techniques are addressed which includes resistive, inductive and impedance switching. The relative comparisons of these methods are analyzed and presented. The simulations of all these cases were carried out in MATLAB/SIMULINK software. It is observed that energization peaks are more significant than the de-energization peaks. While among the different mitigation techniques impedance switching is more effective.

Key Words Capacitor bank switching, Energization, inrush current, Matlab/Simulink software, pre-insertion resistor, Pre-insertion inductor, Pre-insertion impedance, Transient overvoltages, Total Harmonic Distortion

1. INTRODUCTION

The generation of transients is inevitable in the power system network both in the generation side as well as the distribution side. These transients are produced during the switching operations of the circuit breakers. By switching operations of capacitors, high-frequency transients are produced with large magnitudes in small intervals of time. Normally these capacitor banks are shunt connected in a three-phase system. The opening and closing timings of capacitor banks decide the magnitude of the peaks both in current and voltage.

A distribution system is considered where the capacitor banks are required to improve the power factor of the loads. That, in turn, improves the voltage profile of the system. The inherent presence of system inductance and incoming capacitance contribute to the high-frequency transient in switching operations. These transients are mitigated by

using some techniques such as pre-insertion resistor, pre-insertion inductor, and pre-insertion impedance methods.

A distribution system is considered for study simulated separately for energization and de-energization cases. Along with above some mitigation techniques are also simulated and studied.

2. BASIC CONCEPT OF CAPACITOR SWITCHING

The basic concept of energization and de-energization is illustrated using a circuit shown in figure 1. The circuit consists of shunt capacitor c1 and c2 and two switches s1 and s2. While switching operations, transients are produced that are having a nature of high frequency and large peaks.

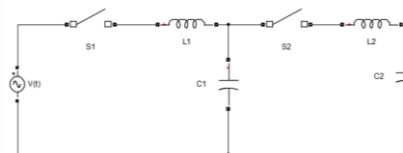

Fig 1: single-line circuit diagram of capacitor switching transients

When s1 is closed the voltage V_{C1} is given by the equation (1).

$$V_{C1}(t) = V - [V - V_{C1}(0)] \sin \omega_1 t \quad (1)$$

$$I(t) = \frac{V}{Z_1} \sin \omega_1 t \quad (2)$$

Where

V- Switch voltage at S_1 closing

$V_{C1}(0)$ - initial voltage at C_1

$\omega_1 = 1/\sqrt{L_1 C_1}$ - Natural frequency

$Z_1 = \sqrt{L_1/C_1}$ - Surge impedance

When switch s2 is closed the voltage across capacitor 2 is given in equation (2).

$$\frac{VC2}{V} = 1 + A \cos \Phi_1 t + B \cos \Phi_2 t \tag{3}$$

$$I_2(t) = \frac{V1 - Vc2(0)}{\sqrt{L2 \left(\frac{C1 + C2}{C1 C2} \right)}} \sin \omega_2 t \tag{4}$$

Where the coefficients A, B, Φ_1 and Φ_2 are calculated from $C_1, C_2,$ and L_1 and L_2

V1 -Voltage at C1 at S2 Closing

VC2 - Initial Voltage at C2

$$\omega_2 = (\sqrt{L2(c1c2/c1 + c2)})^{-1} \text{ Transient frequency}$$

3. MODELING OF NETWORK

A shunt capacitor bank used for switching is shown in fig2. The capacitors are connected in back to back connection. The network considers the industry utility side source with 110 kV. One distribution transformer of a delta to star is used with neutral is grounded. The circuit shown in figure 2 is simulated in figure 3 using MATLAB software.

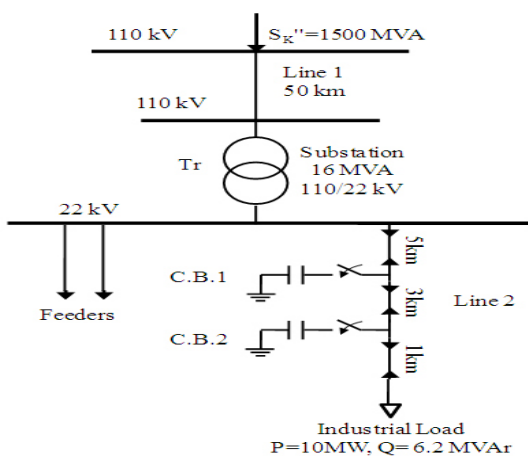

Fig 2: Single – Phase Schematic circuit diagram

Table 1: circuit data

Parameters	Values
Power frequency	16 MVA
Short-Circuit Voltage	(11,53)%
Open-Circuit current	0.22%
Short-circuit loss	62.67 KW
Open circuit loss	(15,17) KW

3.1 Source Voltage (110KV)

This source is connected to the 110 kV using in the Matlab Simulink software. The amplitude voltage equal to $(110 \times \sqrt{2} / \sqrt{3})$ 89.804 kV and internal impedance ($R=0.8, L=25.5636$ mH) calculated from the short circuit value of 1500 MVA.

3.2 Step down transformer

A distribution transformer specification is shown in Table 2.

Table 2: Transformer Parameters

Parameters	Values
Source	110 kV
Distribution transformer	110/22 kV
Load	P=10MW; Q=6.197 MVar
Power factor	0.85 p.f
Capacitor banks	900 KVar; 1400 KVar

3.3 Load

The load is connected before switching on the circuit diagram $R = U^2/P, L = (U^2/Q)/2\pi f$ and $C=0$ the values are listed table below the reactive power of the Capacitors to correct from 0.85 to 0.95 is calculated as $Q=P(\tan 1 - \tan 2) = 2.9$ MVar, then $C=Q/2\pi f U^2 = 19 \mu f$. These values are used in the circuit shown in fig.2.

Table 3: Load parameters

Parameters	Values
P	10 MW
Q	6.197 MVar
$\cos \phi$	0.85
R	48.4 Ω
L	248.72 mH

3.4 capacitor banks

The circuit diagram, two capacitors are used these are connected in the back to back connection. (900, 1400) KVar. Besides the load, a capacitor bank of 2.9 MVar connected and switching is analyzed.

4. CIRCUIT SIMULATIONS

In order to study the effect of the energization of capacitor banks a three-phase circuit is considered shown in fig 3. Switch closing and opening of the capacitor bank is made to observe the transients generation. The given circuit diagram

is simulated in MATLAB simulation software. A scenario of energization produces transients of larger magnitudes than the de-energization.

4.1 Case 1: Capacitor bank Energization

A three-phase capacitor bank is connected to the feeder through a circuit breaker. The study is made by closing the switch at 0.05 s. As a result of that transients with large magnitude and frequency are produced. The peaks in voltage and currents are observed.

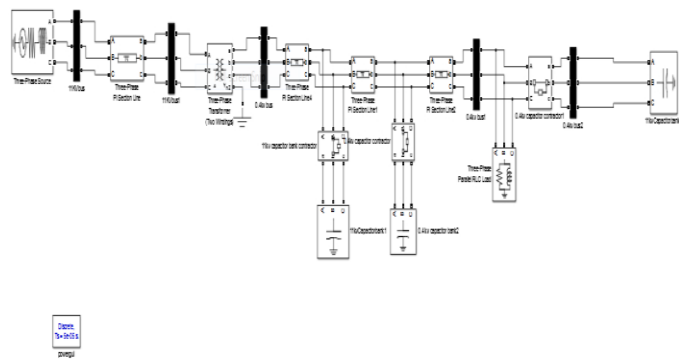

Fig 3: simulation of the Energization of capacitor bank switching.

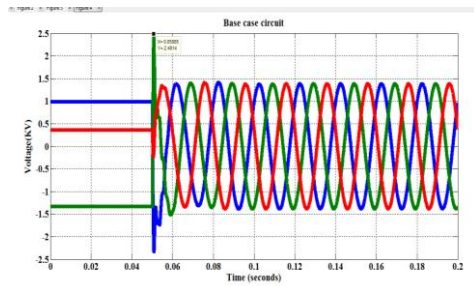

Fig 4(a): transient over voltages during energization

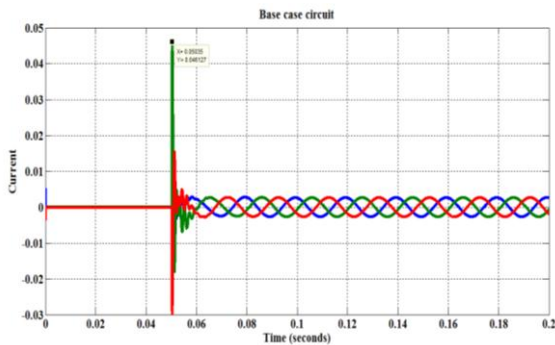

Fig 4(b): Inrush currents during energization

Table 4: Transients are observed Energization of Capacitor bank at phase A Voltage and Current

Phase A	Maximum Peak observed near the capacitor bank when the switch at t=peak
voltages	2.48 P.U
current	2567 A

Figure 4(a) shows the in energization of shunt Capacitor banks wherein transient overvoltages equal to 2.48 KV and inrush current 2.567 KA was observed in fig 4(b).

4.2 THD Analysis of Capacitor bank Energization

A voltage waveform is considered to calculate the total harmonic distortion. This voltage is measured on the load side particularly in phase A. Similarly phase A current is also analyzed at the load side for harmonic analysis. This is because the current also gets distorted due to switching.

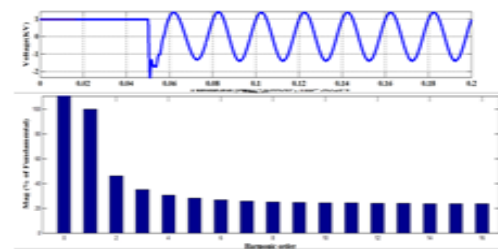

Fig 4(c): THD Analysis of Capacitor bank Energization of voltage without any controlling technique

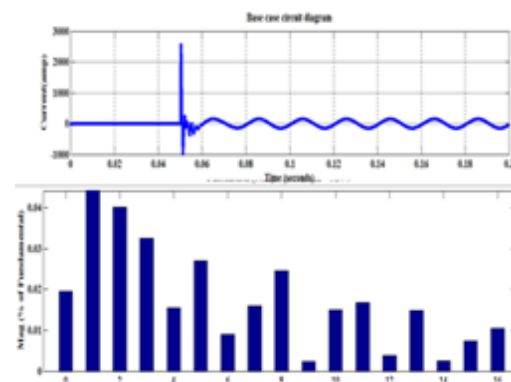

Fig 4 (d): THD Analysis of Capacitor bank Energization of voltage without any controlling technique

Fig 4(c) shows the THD waveform of the voltage of phase A. The total harmonic distortion for voltage 35.34% is observed. Fig 4(d) shows the THD waveform of the current when the shunt capacitor bank switched in the network. Total harmonic distortion for current is 94.14% is observed.

4.3 Capacitor bank De-Energization

In the second case of the circuit, the shunt capacitor bank is opened in the feeder line. A capacitor bank is de-energized at time 0.05s. So produced transient overvoltages and inrush currents of phase A peaks are observed as 1.9246 P.U and 802.8 A respectively.

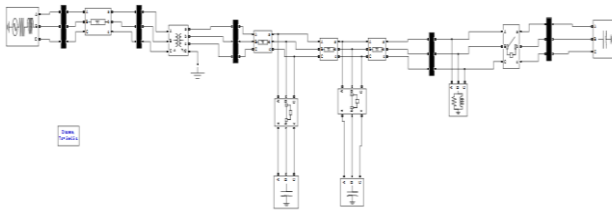

Fig 5: simulation of De-Energization of capacitor bank switching

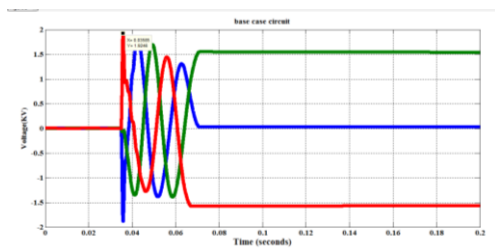

Fig 6(a): transient overvoltages produced during De-Energization of shunt Capacitor banks

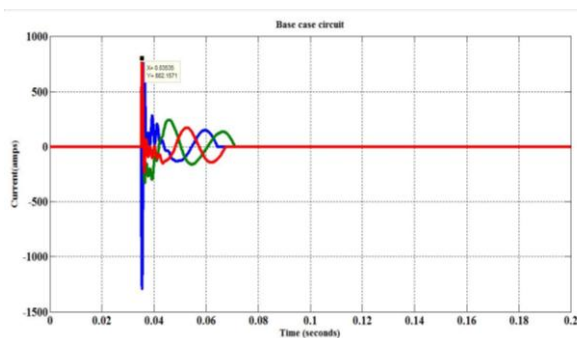

Fig 6(b): Inrush currents during de-energization

Table 5: Transients are observed De-Energization of Capacitor bank at phase A Voltage and Current

Phase A	Maximum Peak observed near the capacitor bank when the switch at t=peak
Voltages	1.9246 P.U
current	802.8 A

Fig. 6(a) shows the transient overvoltages during de-energization of shunt Capacitor banks. Its value is observed as 1.9246 PU and also the inrush current 802.8 A is observed from fig 6(b).

4.4 THD Analysis of Capacitor bank De-Energization

Fig 6(c) shows the second case THD waveform when the shunt capacitor bank switched in the network. Total harmonic distortion for voltage is 15.34% without any controlling technique.

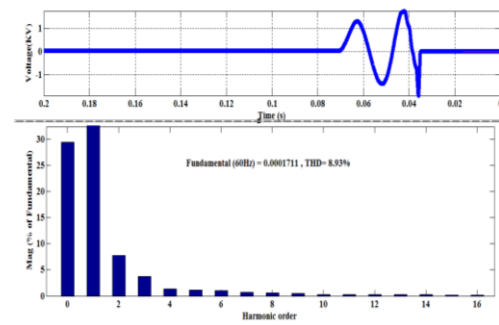

Fig 6(c): THD of a transient voltage of Capacitor bank in de-energization

Fig 6(d) shows the second case THD waveform when the shunt capacitor bank switched in the network. Total harmonic distortion for voltage is 85.34% without any controlling technique.

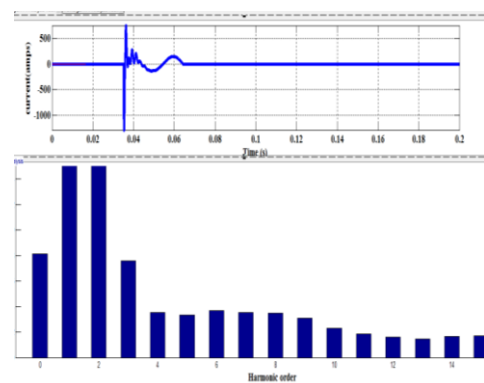

Fig 6 (d): THD Analysis of current in de-energization

5. METHODS FOR MINIMIZING THE TRANSIENT OVER VOLTAGES

5.1 Case 1: Controlling technique by pre-insertion resistor

This is an old classic method that effectively reduces the high magnitude of the transient's overvoltages and high frequency of inrush currents. During capacitor bank energization a pre-insertion resistor is connected in series with the capacitor bank.

In the case of the three-phase system, three resistors are connected in series to three phases of a capacitor bank. In this case, an additional switch is used to disconnect the resistor in one-quarter of a cycle after the energization of the bank. An additional switch is closed at 0.25s, as a result, the resistor was disconnected from the circuit which reduces the steady-state losses.

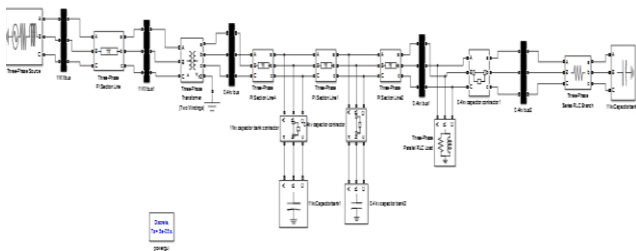

Fig 7: simulation of a system circuit represents the including pre-insertion resistor

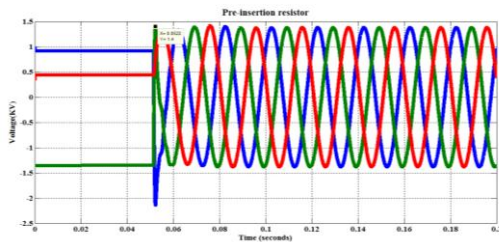

Fig 8 (a): voltage at the controlled Energization capacitor bank using the Pre-insertion resistor

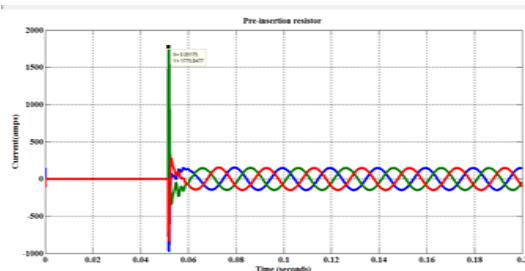

Fig 8 (b): Current at the controlled Energization capacitor bank using the Pre-insertion resistor

Table 6: Transients are observed Energization of Capacitor bank at the Phase A Voltage and Current in pre-insertion resistor switched into the capacitor bank

Phase A	Maximum Peak observed near the capacitor bank when the switch at t=peak
Voltage	1.48 P.U
current	1775.23 A

In figure 8(a) transient overvoltage peak of phase A was observed 1.48 KV and in fig 8(b) the inrush current peak of phase A, 1775.63 A was observed.

5.2 THD analysis in case of Pre-insertion Resistor

Fig 8(c) shows the THD waveform when the shunt capacitor bank switched in the network. The total harmonic distortion of voltage is 18.34% when the capacitor bank switched with a pre-insertion resistor.

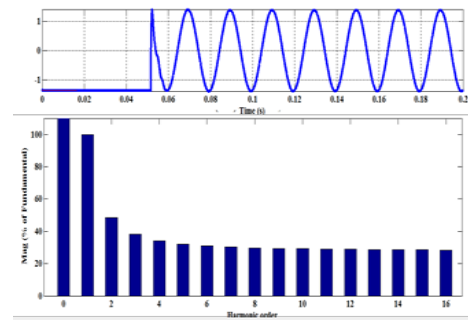

Fig 8 (c): THD Analysis of voltage while Capacitor bank energization with Pre-insertion Resistor

Fig 8(d) shows the THD waveform when the shunt capacitor bank switched in the network. Total harmonic distortion for current is 27.34% when the capacitor bank switched with a pre-insertion resistor.

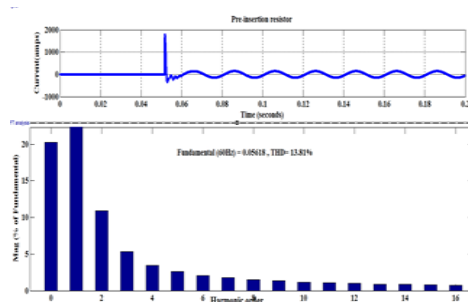

Fig 8 (d): THD Analysis of Capacitor bank energization of current with Pre-insertion Resistor

5.3 Case 4: Controlling technique by the pre-insertion inductor

A pre-insertion inductor is an old classical controlling technique. The pre-insertion inductor effectively controls the high frequency of inrush current of the energization of the capacitor bank. It also reduced the high magnitude of transient overvoltages.

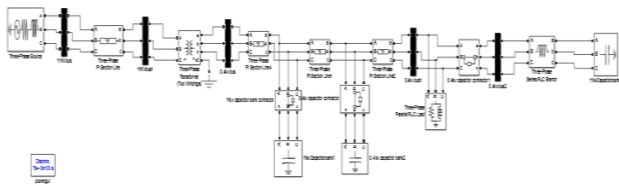

Fig 9: simulation of a system circuit represents the including pre-insertion inductor

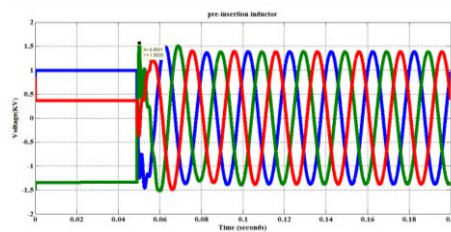

Fig 10 (a): voltage at the controlled Energization capacitor bank using the Pre-insertion inductor

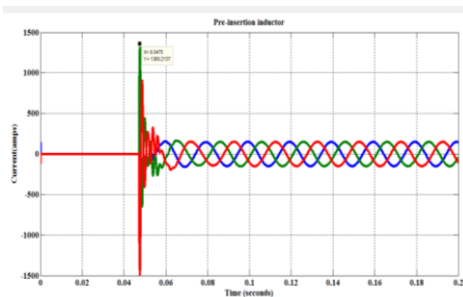

Fig10 (b): current at the controlled Energization capacitor bank using the Pre-insertion inductor

Table 7: Transients are observed Energization of Capacitor bank at the phase A Voltage and Current in pre-insertion inductor switched into the capacitor bank

Phase A	Maximum Peak observed near the capacitor bank when the switch at t=peak
voltage	1.58 KV
current	1360.21 A

figure 10(a) Shows the pre-insertion inductor transient overvoltage of phase A about 1.58 KV and fig 10(b) also shows a damped inrush current peak of phase A, 1360.21A was observed.

5.4 THD analysis of pre-insertion inductor case

Fig 10(c) shows the THD waveform when the shunt capacitor bank is switched in the network. Total harmonic distortion for voltage is 12.34% when the capacitor bank switched with the pre-insertion inductor.

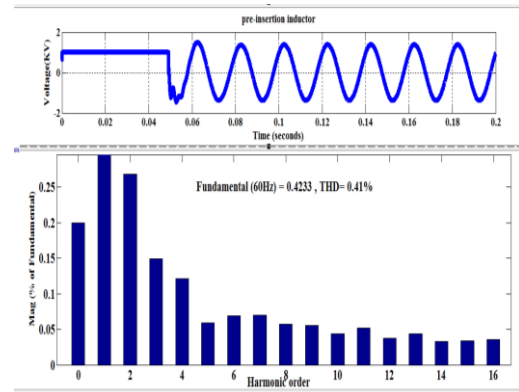

Fig10(c): THD Analysis of Capacitor bank energization of voltage with Pre-insertion inductor

Fig 10(d) shows the THD of when the shunt capacitor bank switched in the network. Total harmonic distortion for voltage is 50.34% when the capacitor bank switched with a pre-insertion inductor.

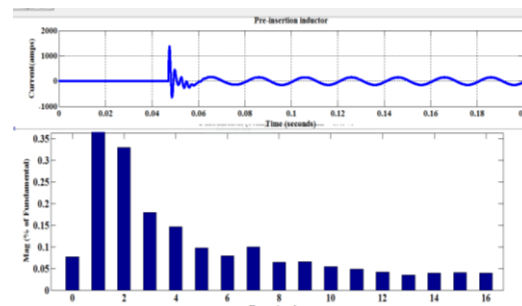

Fig 10 (d): THD Analysis of Capacitor bank energization of current with Pre-insertion inductor

5.5 Case 5: Controlling technique of pre-insertion impedance

Pre-insertion of impedance also an old classical method is shown in Fig.11. Where a series-connected resistor and inductor are used. Pre-insertion impedance controls the overvoltages and heavy currents. When energizing a capacitor bank high magnitude of transient overvoltages and high-frequency inrush currents are produced. It is observed that the pre-insertion impedance effectively reduced the transients than the pre-insertion resistor, pre-insertion inductor. It involves less loss and more efficient.

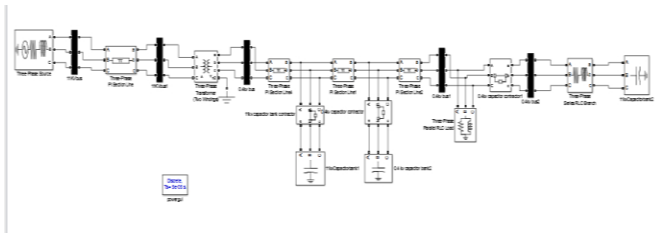

Fig 11: simulation of a system circuit represents the including pre-insertion impedance

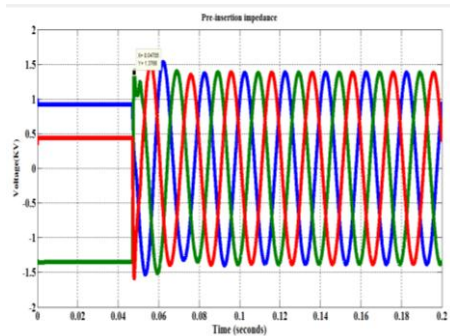

Fig12 (a): voltage at the controlled Energization capacitor bank using the Pre-insertion impedance

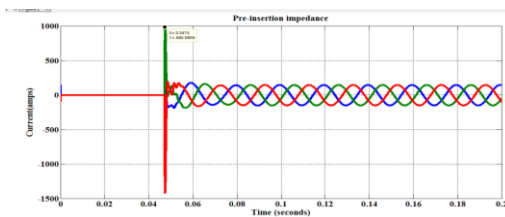

Fig 12(b): Current at the controlled Energization capacitor bank using the Pre-insertion impedance

Table 8: Transients of phase A Voltage and Current in Pre-insertion impedance switched into the capacitor bank

Phase A	Maximum Peak observed near the capacitor bank when the switch at t=peak
voltage	1.35 KV
current	985 A

Figure 12(a) shows the transient overvoltage with pre-insertion impedance was the peak of phase A 1.35 KV and also damped the inrush current of phase A to 985A is observed in fig 12(b).

5.6 THD analysis of pre-insertion impedance case

Fig 12(c) shows the THD waveform when the shunt capacitor bank switched in the network. Total harmonic distortion for voltage is 8.34% when the capacitor bank switched with pre-insertion impedance.

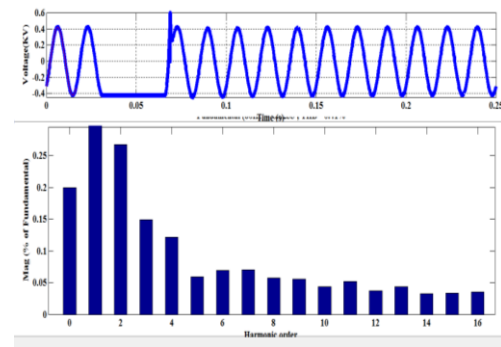

Fig 12(c): THD Analysis of Capacitor bank energization of voltage with Pre-insertion impedance

Fig 12(d) shows the THD waveform when the shunt capacitor bank switched in the network. Total harmonic distortion for current is 20.34% when the capacitor bank switched with pre-insertion impedance.

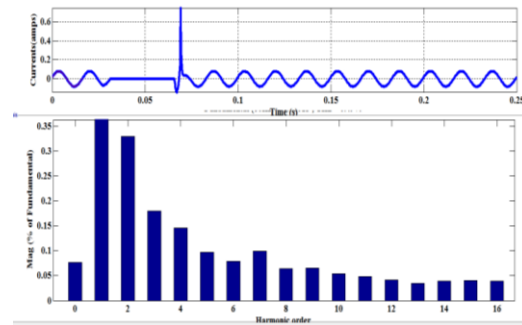

Fig 12 (d): THD Analysis of Capacitor bank energization of current with Pre-insertion impedance

6. CONCLUSION

This paper has concluded the Energization in the shunt capacitor banks. In this Energization capacitor banks generated the high magnitude of transient overvoltages and high frequency of inrush currents. In this Transient overvoltages and inrush currents are controlling several techniques they are pre-insertion resistor effectively reduced the high magnitude transient voltages and currents and also some loss is produced. The second mitigating technique pre-insertion inductor is also reduced the transient overvoltages damped the inrush current are reduced. Third mitigating technique Pre-insertion Impedance is mostly reduced the high magnitude of transients overvoltages and high frequency of inrush current are reduced few mill seconds used in this pre-insertion impedance cost is reliability. Circuit mathematical calculates the voltages, currents, and frequencies are simulation using the Matlab/Simulink software to find out the solution.

REFERENCES

- [1] CIGRE WG13.04, "Shunt Capacitor Bank Switching - Stresses and Test Methods, 1st Part: Electra No 182, February 1999 -2nd Part: Electra No 183, April 1999.
- [2] D. F. Miller. 1976. Application guide for shunt capacitors on industrial distribution systems at medium voltage levels. IEEE Transactions on Industry Applications Vol. 5, pp. 444-459. PAS, Vol. 106, No. 4, pp 221-230, April 1986.
- [3] S.S.Mikhail and M. F. McGranaghan, "Evaluation of Switching Concerns Associated with 345 kV Shunt Capacitor Applications.," IEEE Transactions PAS, Vol. 106, No. 4, pp 221-230, April 1986
- [4] Richard H. Webster, O.J.M. Smith, "Series Capacitor Switching to Quench Electromechanical transients in power system".IEEE Transaction on power apparatus and systems, Vol.Pas-90,No.2,1971
- [5] Ali, S.A.W. "Capacitor Banks Switching Transient in Power System", vol. 2, No. 2, pp. 62-73, Canada, July 2011.
- [6] Greenwood, A. "Electrical Transients In Power Systems", vol. 3, No.4, pp. 37-46, New York, USA, August 1996.
- [7] Grebe, T.E. "Application of Distribution System Capacitor Banks and their Impact on Power Quality", IEEE Transactions on Industry Applications, vol. 32, No. 3, pp. 714-719, October 1996.
- [8] Das J.C., "Analysis and Control of Large Shunt Capacitor Bank Switching Transient," IEEE Transactions on Industry Application, vol. 41, No. 6, pp. 1444-1451, October 2005.
- [9] D.V. Coury. "Transient analysis concerning capacitor bank switching in a distribution system". Electric Power Systems Research. vol. 65, No. 1, pp. 13-21, February 2001
- [10] Chun, L., "Initial Voltage Change on Capacitor Switching", IEEE Transactions on Power Delivery, Volume 27, No. 1, January 2012.