

# Design and optimization of HAT STIFFENED PLATE using Finite element method

Rishi Aneja<sup>1</sup>, Prof. Anshul Choudhary<sup>2</sup>, Prof. Kamal Kumar Jain<sup>3</sup>, Dr.R.K Dave<sup>4</sup>

<sup>1</sup>P.G student, SRIT, Jabalpur,(M.P) 482002

<sup>2</sup>Prof., Mechanical Dept, SRIT Jabalpur,(M.P)482002

<sup>3</sup>H.O.D, Mechanical Dept, SRIT, Jabalpur,(M.P)482002

<sup>4</sup>Prof., Mechanical Dept, SRIT Jabalpur,(M.P)482002

\*\*\*

**Abstract** - Hat Stiffened Plates are used in composite ships and are gaining popularity in metallic ship construction due to its high strength-to-weight ratio. Light weight structures will result in greater payload, higher speeds, reduced fuel consumption and environmental emissions. Analysis of stiffened plate has always been a matter of concern for the structural engineers since it has been rather difficult to quantify the actual load sharing between stiffeners and plating. Finite Element Method has been accepted as an efficient tool for the analysis of stiffened plated structure.

In this paper the models of hat stiffeners plate have been modeled in CATIA software and Numerical Investigations have been carried out by using the commercial Finite Element software ANSYS 18 to substantiate the high strength-to-weight ratio of Hat Stiffened Plates over other open section stiffeners which are commonly used in ship building.

In this work an existing work of hat stiffened plate has been taken and by changing certain parameters of the model the strength of model has been increased.

There are two parameters in which work has been done, one is changing the angle of stiffeners and another is changing the height of stiffeners and by analysis it is found that as the angle of stiffener increases the strength also increases and if the height of stiffeners increases than also the strength of stiffeners plate increases.

**Key Words:** Hat stiffened plate, Finite element method, Ansys, angle, height and fillet of stiffened plate.

## 1. INTRODUCTION

Ship structure is considered as a three dimensional frame work of stiffened plates, constituted by deck, shells and bulkheads. The

stiffened plates are assembled as a stiffened plate or panel where the stiffeners are welded on to one side of the plate in either of both directions. The commonly used Open sections in ship structure are Flat Bar, Angle, Holland Profile (bulb-plate) and Tee. Trapezoidal or Hat shaped stiffener is a closed section stiffener which is commonly used in the case of composite structures but is not very common in metallic structures.

Light weight ships are more popular because it allows a greater payload for a given steel weight of the vessel and allows higher speeds to be achieved. The result for constructing light weight ships is to reduced fuel consumption and environmental emissions for a given payload and distance travelled. By also improving in structural configuration the weight of the structure can be reduced. Thus, introduction of Hat Stiffened Plate (HSP) of steel is design for ship to construct light weight stiffened panels.

HSP contain number of closed profile stiffeners which is provided along the dominant direction as shown in Figure 1.1. In the case of steel structures, the stiffeners can be welded or riveted to the plate and if riveted than flanges are provided for the stiffener.

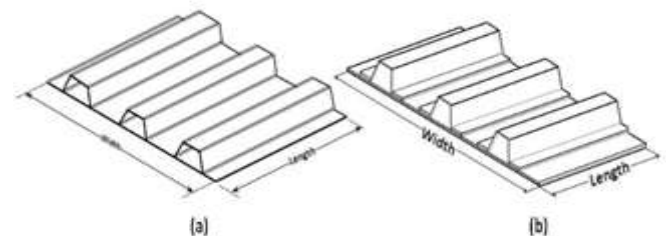

Figure 1.1 Schematics of a typical: (a) Metallic Hat Stiffened Plate (b) Composite Hat Stiffened Plate.

HSPs are used as deck plate and bulkheads in ship structure, and they are also used in side panels of transit containers, sheet piles for various application and structural panels.

It has been always a matter of concern for the engineers rather difficult to quantify the interaction between stiffeners and plating or the actual load sharing between these two. The interaction of beams and plating is an interaction between two modes of loading and response. The Strain energy method have limited scope for actual stiffened plate problems but it has always remained as a solution strategy. Finite Element Method (FEM) or Finite Element Analysis (FEA) are the application of matrix method and subsequent developments which solves the complexities of analysis of stiffened plated structure. Over the last few decades the single biggest development in ship structural design and analysis has been the introduction and acceptance of FEM as the structural analysis strategy. This tool offers both faster and more accurate solution to ship structural systems with complexities in geometry and boundary condition.

By using FEM, analysis has been brought out at different scale levels like complete ship, hull module and principal members like stiffened panels, frames, girders etc. There are some difficulties which have been come in the selection of elements, the choice of nodal positions and the method of connecting the beam and membrane elements in FEM. The Best results can be seen using when both the stiffeners and the plate are modeled using thin plate elements having six degrees of freedom (dof) per node. On the other side one serious problem is observed with this design and analysis process as the finite element models are generated for a complex configuration is time consuming and laborious. If each stiffener is represented individually while modeling a complete ship or hull module of a ship, is a complex procedure and it will result in excessive amounts of storage. To solve these difficulties two different methods that is Orthotropic Plate Model (OPM) and Super element for HSP have been suggested for the FEA of HSP in the present work. The HSP method which is made of isotropic material and having geometric orthotropy has been replaced with an OPM having the same plan dimensions and material orthotropy. The OPM can be modeled and analyzed at any time using an orthotropic plate finite element which is available in the element library of any general finite element

software. In the second method, the HSPs can be analyzed using Super element developed without making any compromise on the accuracy. In the Super element technique a portion of the structure is treated as a single element if it is made up of many individual element.

## 2.0 The objectives of the paper

The objectives of the present work have been listed below:

1. By taking the original hatt stiffened model the certain geometrical parameter of hatt stiffened plate has been changed.
2. Firstly the angles of the hatt stiffeners has been changed in order to increase the strength of the plate.
3. Secondly the height of hatt stiffeners was changed.
4. And at the last the fillet has been provided at all the edges of stiffeners attach to the plates.

## 3.0 METHODOLOGY

### 3.1 GENERAL

The ship structure consists of bottom and side shell plating, deck plating, transverse bulkheads, fore end, aft end and super structure as shown in Figure 3.1. Bottom and side shell plating acts as a envelope of the ship and a principal strength member. Deck plating and transverse bulkheads which contribute substantially to the strength of the structure may also serve as liquid tight boundaries of internal compartments. Fore end accommodate bulbous bow, aft end accommodates the propeller and super structure accommodate area and Navigation Bridge. After end and superstructure of a ship structure apart from the fore end, in general is a three dimensional frame work of stiffened plates, constituted by deck, side shells, bottom shell and bulkheads.

The stiffeners attached successfully to the plating contribute to the general longitudinal strength of the ship and will withstand the cargo and water pressure loads. For reducing scantlings they are supported at locations other than bulkheads by deep transverse beams in the decks and

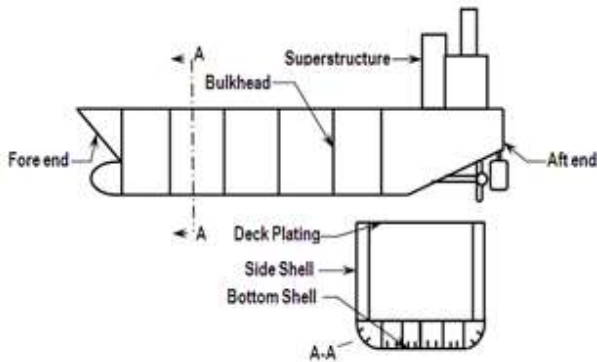

Figure 3.1 Key element of ship

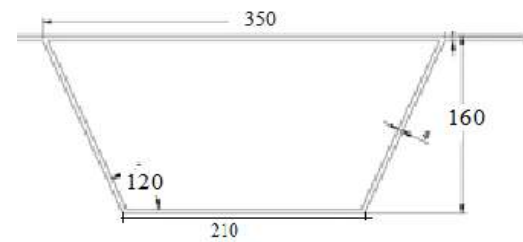

Figure 3.2 Geometry and dimensions of Hat Stiffened Plate.

by providing transverse floors in the bottom. The transverse strength of the ship is increase the transverse bulkheads and have the same effect as the ends of a box. Several lateral load acts initially on the plating in a ship structure by the action of plate bending, which in turns transmits the load to transverse beams and longitudinal girders.

Ship's structure like quartering sea causes twisting of the structure about the longitudinal axis.

A ship structure at sea is subjected to static and dynamic forces which causes the distortion of the structure. The ship structure is subjected to static forces, due to the water surrounding the ship, due to the weight of the cargo and due to the weight of the structure itself. The effect of these static forces is to cause a transverse distortion.

The main agenda in ship building is to design a structure having minimum weight and maximum strength. The strong build ships are heavy, slow and costs more to build and operate as they weigh more, while ships which are built too weak suffer from minor hull damage and in some cases catastrophic failure and sinking is occurred. Hence to design strong and lighter ships there has always been a constant strive among ship designed. In the present chapter the structural response of plates stiffened with hat stiffeners, flat bar, angle bar and Tee bar, subjected to lateral loading, in-plane loading and torsion loading has been investigated. To establish the high strength-to-weight ratio of HSPs and the results have tabular form have been carried out by numerical investigation in ANSYS 18.

### 3.2 DESCRIPTION OF HAT STIFFENED PLATE

Jia and Ulfvarson (2005) proposed a section of the stiffened plate between two successive transverse deck beams of a conceptual light weight ship deck on a pure car truck carrier vessel having a span of 2.4 m which has been selected for the various numerical investigation in this thesis.

#### 3.2.2 Selection of Representative Unit Cell for Hat Stiffened Plate

##### 3.2.1 Structural Characteristics

The figure shows the geometry and dimensions of HSP having two stiffeners and the principal dimensions of the hat stiffener. The structure is made with EHS690 steel. The Poisson's ratio of the material is 0.3, the modulus of elasticity is 210 GPa, density is  $7800 \text{ kg/m}^3$ , and the yield stress is 690 MPa.

The deck plate of ship or similar structural components strengthened with hat stiffeners may be measuring a few meters as a structural member and may consist of large number of hat stiffeners. For the structural analysis of such components, it will be convenient to have a Representative Unit Cell (RUC) which is a miniature of the original structure. An RUC of the HSP has been selected based on a linear static analysis carried out for HSP panels having two, three, four and five stiffeners. Geometry of these RUCs has been given in Figure 3.2 (a) and Figure 3.4. Simply supported boundary conditions are prescribed on edges perpendicular to the stiffeners and continuous boundary conditions have been imposed on edges parallel to the stiffeners. A uniformly distributed lateral pressure of 10 kPa has been applied on the HSP.

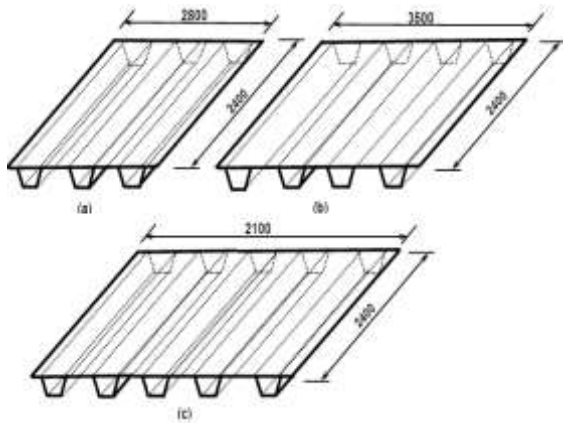

**Figure 3.3** Geometry and dimensions of Hat Stiffened Plates having: (a) three stiffeners (b) four stiffeners and (c) five stiffeners.

Comparison of maximum deflection and maximum in-plane stress at the centre of HSP having two, three, four and five stiffeners has been presented in this work.

**3.3 METHODOLOGY AND ANALYSIS PROCEDURE-**

Firstly the models of all the hatt stiffened plates has been made by using a 3D Modelling software CATIA V5R20 and then all the models have been saved in the format of .stp, and then these all the models have been import in the analysis software called Ansys Workbench 18 and by creating the meshing and applying boundary condition the performance of all the models of hatt stiffened plate has been checked.

**4.0 RESULTS AND DISCUSSION**

**4.1 Comparisons of results for different degree angle stiffeners.**

Here in this section the angles of stiffeners has been changed and then the deformation, maximum principal stresses and shear stresses was compared.

**Table 4.1-** Deformation of angled stiffeners plate

DEFORMATION (mm)						
NO OF STIFFENERS	90°	100°	110°	120°	130°	
3	1.34	1.14	0.709	0.52	0.81	
4	1.18	1.16	0.71	0.43	0.78	
5	1.18	1.12	0.7	0.44	0.83	

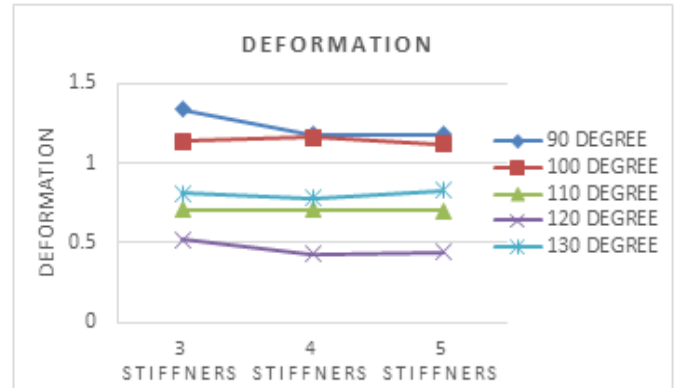

**Graph 4.1-** Deformation of angled stiffeners plate

**Conclusion:** - From Graph and Tables it is clear that as the angles of stiffeners increases the value of deformation decreases but after 120 degree stiffeners angle the deformation again start increasing.

**Table 4.2-** Maximum principal stress of angled stiffeners plate

MAXIMUM PRINCIPAL STRESS (MPa)						
NO OF STIFFENERS	90°	100°	110°	120°	130°	
3	55.19	47.6	32.46	27.21	41.34	
4	54.83	48.78	33.14	27.88	41.24	
5	56.78	46.81	32.89	28.68	42.13	

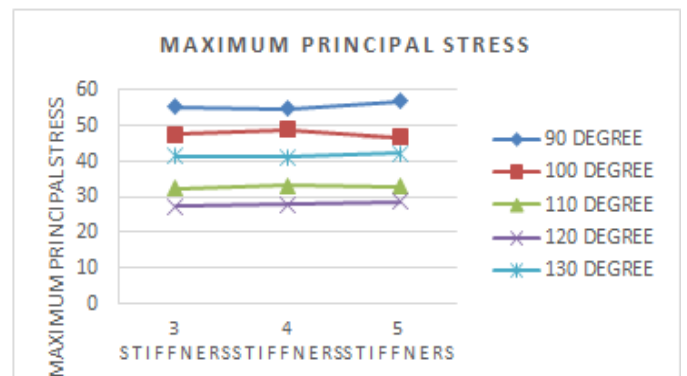

**Graph 4.2-** Maximum principal stress of angled stiffeners plate.

**Conclusion:** - From Graph and Tables it is clear seen that as the angles of stiffeners increases the value of Maximum principal stresses decreases but after 120 degree stiffeners angle the Maximum principal stresses again start increasing.



**Table 4.3-** Shear stress of angled stiffeners plate

SHEAR STRESS (MPa)					
NO OF STIFFENERS	90°	100°	110°	120°	130°
3	9.33	10.23	8.74	7.73	11.37
4	9.98	11.18	9.41	8.29	11.98
5	10.12	12.17	9.67	8.5	12.36

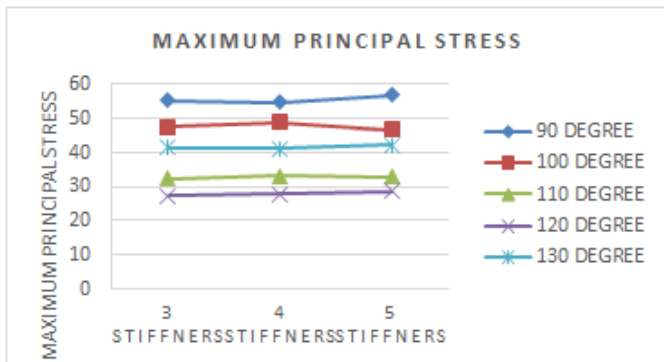

**Graph 4.3-** Shear stress of angled stiffeners plate

**Conclusion:** - From Graph and Tables it is clear that as the angles of stiffeners increases the value of Shear Stresses decreases but after 120 degree stiffeners angle the Maximum principal stresses again start increasing.

**4.2 Comparisons of results for different height of stiffeners.**

Here in this section the height of stiffeners has been changed and then the deformation, maximum principal stresses and shear stresses was compared.

**Table 4.4-** Deformation of stiffeners plate with changing height.

DEFORMATION (mm)						
NO OF STIFFENERS	140 MM	145 MM	150 MM	155 MM	160 MM	
3 STIFFENERS	0.67	0.64	0.58	0.55	0.52	
4 STIFFENERS	0.66	0.62	0.59	0.56	0.51	
5 STIFFENERS	0.65	0.61	0.6	0.54	0.51	



**Graph 4.4-** Deformation of stiffeners plate with changing height.

**Conclusion:** - From Graph and Tables it is clear that as the height of stiffeners increases the value of Deformation decreases.

**Table 4.5-** Maximum principal stress of stiffeners plate with changing height.

MAXIMUM PRINCIPAL STRESS (Mpa)						
NO OF STIFFENERS	140 MM	145 MM	150 MM	155 MM	160 MM	
3 STIFFENERS	35.3	34.2	32.98	32.11	31.1	
4 STIFFENERS	35.7	34.7	33.16	32.34	31.34	
5 STIFFENERS	35.9	34.9	33.21	32.2	31.65	

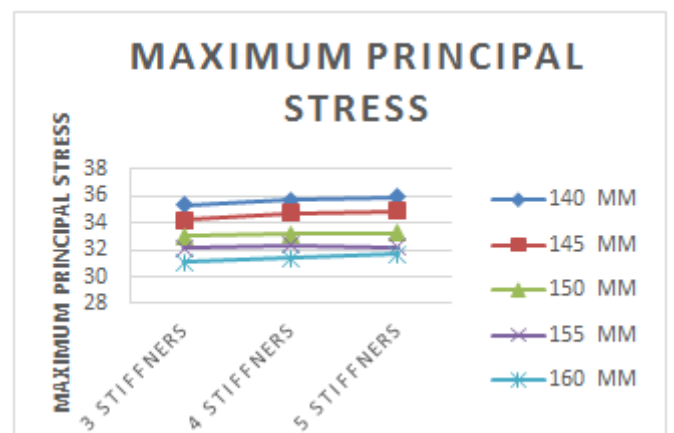

**Graph 4.5-** Maximum principal stress of stiffeners plate with changing height.

**Conclusion:** - From Graph and Tables it is clear that as the height of stiffeners increases the value of Maximum Principal Stresses decreases.

**Table 4.6** - Shear stress of stiffeners plate with changing height.

SHEAR STRESS (Mpa)						
NO OF STIFFENERS	140 MM	145 MM	150 MM	155 MM	160 MM	
3 STIFFNERS	9.15	8.95	8.75	8.61	8.12	
4 STIFFNERS	9.08	9.02	8.55	8.52	8.21	
5 STIFFNERS	9.11	9.05	8.51	8.48	8.15	

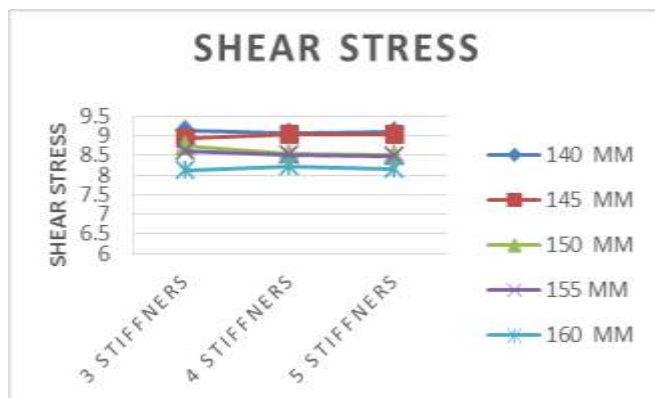

**Graph 4.6-** Shear stress of stiffeners plate with changing height

**Conclusion:** - From Graph and Tables it is clear that as the height of stiffeners increases the value of Shear Stresses decreases.

### 5.0 FINAL CONCLUSION.

1. From all the graphs and tables (by taking parameter of change in angle of stiffener) it is found that as the angle of stiffeners increases the deformation , maximum principal stresses and shear stresses decreases up to 120 degree stiffener angle hence it results in increase the strength of plate.

2. From all the graphs and tables (by taking parameter of change in a height of stiffener) it is found that as the height of stiffeners increases the deformation , maximum principal stresses and shear stresses decreases hence it results in increase the strength of plate.
3. And finally if the optimum results of all the parameters has been compared with the original model of stiffener plates it is found that the stiffeners shows the minimum value of deformation , maximum principal stresses and shear stress compared to all other models
4. Usage of Hat Stiffened Plate for ship structure can effectively reduce the weight as compared to commonly used open section stiffeners. Light weight structure will result in faster, more economical and environment friendly ships.

### 6.0 REFERENCES

1. Manoj g tharian · nandakumar. Article · mar 2013 "hat stiffened plates for ship building".
2. Manoj g. Tharian · nandakumar c. Gopalakrishnan. "orthotropic plate model of hat stiffened plate".
3. Manoj g tharian · nandakumar c g." Hat stiffened plates for ship building"
4. Atul v. Karanjkar & nilotpal banerjee department of mechanical engineering, nit durgapur, west bengal, india." A frequency based free vibration analysis of a hat stiffened plate, for identification of the damage".
5. manoj g tharian, nandakumar c gopalakrishnan first published july 3, 2013." Orthotropic plate model of hat stiffened plate".
6. Dr alice mathai1 , shiney varghese2 , t.v.alice3." Finite element buckling analysis of stiffened plates".
7. Anupama b. M1 , jayashankar babu b. S2." Analysis of stiffened plate using fe approach".
8. Adini, A. and Clough, R. W. (1960): Analysis of Plate Bending by the Finite Element Method, Report submitted to the National Science Foundation, Washington D C.

9. Bao, G., Jiang, W. and Roberts, J.C. (1997): Analytical and Finite Element Solutions for Bending of Orthotropic Rectangular Plates, *Int. J. Solids Structures*, 14, pp. 1797 -
10. Bathe, K. J. and Dvorkin, E. N. (1985): Short Communication A Four Node Plate Bending Element based on Mindlin/Reissner Plate Theory and a mixed Interpolation, *International Journal for Numerical Methods in Engineering*, vol. 21, pp. 367-383.
11. Bediar, O. K. (1997a): The elastic behavior of multi-stiffened plates under uniform compression, *Thin Walled Structures*, vol. 27, pp. 311-335.
12. Bediar, O.K. (1997b): Analysis of stiffened plates under lateral loading using sequential quadratic programming (SQP), *Computers & Structures*, vol. 62, pp. 63-80.
13. 13. Bogner, F. K., Fox, R. L. and Schmit, L. A. Jr. (1965): The Generation of Inter element Compatible Stiffness and Mass Matrices by use of interpolation formulas, *Proceedings of 1st conference on Matrix Method in Structural Mechanics*, pp.