

THREE-PHASE TO SEVEN-PHASE POWER CONVERTER USING PI CONTROLLER AND TRANSFORMER

Seema Dhill¹, Rahul Baghel²

^{1,2}Dept. of Electrical Engineering, Shri Shankaracharya Engineering College, Durg, C.G., India

ABSTRACT - Multiphase i.e. more than three-phase electric power electric drive system has been the focus of a significant research since the last decade. Multiphase power transmission system has also been discussed in the following literature as multiphase transformers are needed at the input of rectifiers. The number of phases investigated is a multiple of three in the multiphase power transmission and multiphase rectifier systems. The variable speed multiphase drive system considered in this paper are mostly of five, seven, nine, eleven, twelve, and fifteen phases. Power electronic converters are used for supply for such multiphase drive systems. This paper proposes a technique to obtain seven-phase output from three-phase supply system using special transformer connections. Thus, with the proposed technique, a pure seven-phase sine-wave voltage/current is obtained, which can be used for motor testing purposes. In this paper generation of seven phase sine wave voltage and current is discussed using multi winding transformer to step up and a PI controller to reduce the noises and errors in the converted signal. A seven-phase power transmission and rectifier system may get the benefits from the proposed connection scheme.

KEYWORDS- Transformer, multiphase drive systems, multiphase system, multiphase transmission, three-to-seven phase, PI Controller.

I. INTRODUCTION

The applicability of multiphase systems has been explored in electric power generation, transmission, and utilization. The six-phase transmission systems were researched due to rising cost of way for transmission corridors, environmental issues, and various strict licensing laws. Six-phase transmission lines provide the same power capacity with a lower line voltage and smaller towers as compared to a standard double circuit three-phase line. The dimension of the six-phase smaller towers leads to the reduction of both the magnetic fields and electromagnetic interference. The research on multiphase generators has been started recently. This work on multiphase power generation detects an asymmetrical six-phase i.e. two set of stator windings with 30° phase displacement. Induction generator configuration is used in renewable energy systems is detected. The research on multiphase drive systems has been developed due to advancement in semiconductor devices and digital signal processor technologies. Detailed reviews on the multiphase drive research are presented in the papers [15] [18] and [36]. It is to be emphasized that ac to dc and dc to ac converters supply the multiphase motors. Thus, the focus of the current research on multiphase electric drives is mainly restricted to the modeling and controlling of the power converters and has been discussed on papers [19],[24], [32], [33], [37] and [39]. The static transformation system to change the phase number from three-to- n -phase where $n > 3$ and odd is seen. The paper [25] presents a new type of transformer, which is three-to-five-phase system. In papers [41] and [42], a solution for three-to-five-phase conversion is presented. The paper [41] discusses the seven-phase system only. In this approach the phase angle between two consecutive phases is not an integer number is shown.

Multiphase, especially 6 and 12 phase, systems are the systems which are found to produce less amplitude of ripples with higher frequency in ac to dc rectifier system [31]. Thus, 6 and 12 phase transformers are designed for multi pulse rectifier system. Recently, on 24 and 36 phase transformer systems were proposed for supplying a multi pulse rectifier system, which has been discussed in paper [26]. The 6, 12, or 24 phase system is selected for the reason that these numbers are multiples of three and designing such system is simple and easy. However, on increasing the number of phases complicates the system. No such designing is done for odd number of phases such as 7, 11, etc.

The usual way for analysis is to test the designed motor for a number of operating conditions with pure sinusoidal supply [30]. No-load test, blocked rotor, and load tests are performed on a motor to determine the parameters required. Although the supply used for multiphase motor drives obtained from multi-phase inverters could have more current ripples, there are methods available to lower the current distortion below 1%, based on application and requirement, which is discussed in paper [23]. The machine parameters obtained by applying PWM inverter may not provide the correct value. Thus, a pure sinusoidal supply system is needed to feed the motor for better analysis. So this paper proposes a special transformer connection scheme to obtain a balanced three-to-seven-phase supply with the sinusoidal waveforms. The application

areas of the proposed transformer are the electric power transmission system, power electronic converters which are ac to dc and ac to ac, and the multiphase electric drive system.

The fixed three-phase voltage and fixed frequency in the grid power supply can be transformed to fixed voltage and fixed frequency seven-phase output supply. And the output magnitude may be made variable by inserting a three-phase autotransformer at the input side.

Since input is a three-phase system the windings are connected in usual manner and have not been discussed in this paper. The output or the secondary side star connection is discussed below in the following sections. The heptagon output connection may be derived following a similar approach so, only star output connection is discussed in the following section and other connections are omitted.

II. WINDING ARRANGEMENT FOR SEVEN-PHASE STAR OUTPUT

Three separate iron cores are designed, each of them are carrying one primary and four secondary coils, except in one core where five secondary coils are wounded. Six terminals of primary windings are connected in an appropriate manner resulting in star and/or delta connections, and the 26 terminals of secondary windings are connected in a different fashion resulting in a star or heptagon output. The connection scheme of secondary windings to obtain star output is illustrated in figures (1) and (2) below and the corresponding phasor diagram is illustrated in the figure (3) below. The construction of output phases with requisite phase angles of $360/7 = 51.43^\circ$ between each phase is obtained using the appropriate turn ratios and the corresponding phasor equation is illustrated in equation (1c) below. The turn ratios are different in each phase as shown in the figure (1). The choice of turn ratio decides the requisite phase displacement in the output phases. The turn ratios between different phases are given in Table I.

The input phases are designated with letters “X,” “Y,” and “Z” and the output are designated with letters “a,” “b,” “c,” “d,” “e,” “f,” and “g” respectively. The mathematical basis for this connection is the addition of the real and imaginary parts of the vectors. For example, the solution for (1a) gives the turn ratio of phase “b,” where V_b is taken as unity.

$$V_z \left[\cos \left(\frac{2\pi}{7} \right) + j \sin \left(\frac{2\pi}{7} \right) \right] - V_x \left[\cos \left(\frac{\pi}{21} \right) - j \sin \left(\frac{\pi}{21} \right) \right] = 1. \quad (1a)$$

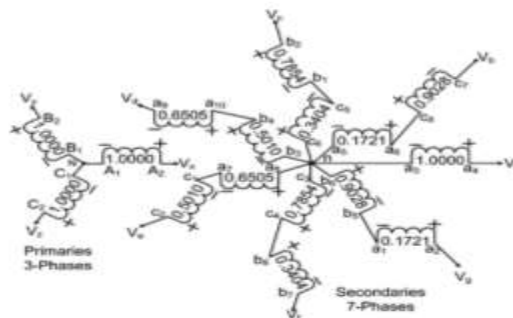

Figure 2.1. Proposed transformer winding connection (star)

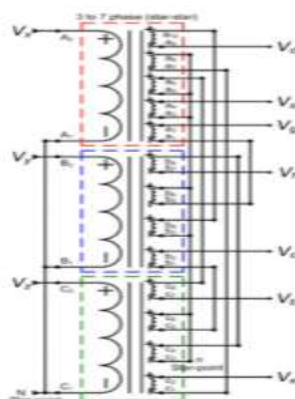

Figure 2.2. Proposed transformer winding arrangements (star-star)

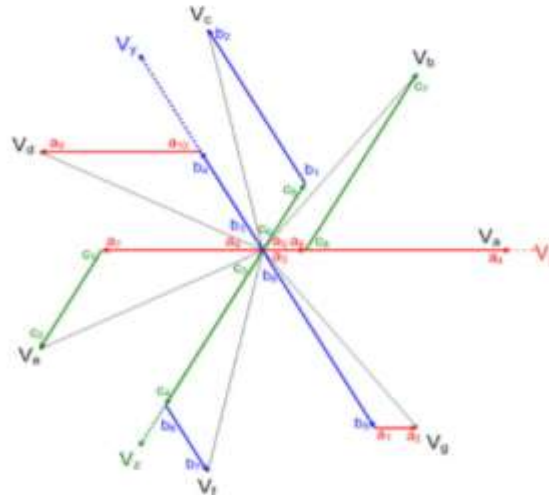

Figure 2.3. Phasor diagram of the proposed transformer connection (star-star)

Table 1: Turn ratio secondary turns (N2) to primary turns (N1)

Name of winding	Turn Ratio N ₂ /N ₁	Name of winding	Turn Ratio N ₂ /N ₁	Name of winding	Turn Ratio N ₂ /N ₁
a ₁ a ₂	0.1721	b ₁ b ₂	0.7854	c ₁ c ₂	0.5010
a ₃ a ₄	1.0000	b ₃ b ₄	0.5010	c ₃ c ₄	0.7854
a ₅ a ₆	0.1721	b ₅ b ₆	0.9028	c ₅ c ₆	0.3404
a ₇ a ₈	0.6505	b ₇ b ₈	0.3404	c ₇ c ₈	0.9028
a ₉ a ₁₀	0.6505				

On equating real and imaginary parts and solving for V_x and V_z, we get

$$|V_x| = \left| \frac{\sin(\pi/21)}{\sin(\pi/3)} \right| = 0.1721$$

$$|V_z| = \left| -\frac{\sin(2\pi/7)}{\sin(\pi/3)} \right| = 0.9028. \quad (1b)$$

Thus, by summing the voltages of two different coils, one output phase is created. It is important to note that the phase “a” output is generated from only one coil namely “a3a4” whereas in contrast to other phases which utilizes two coils. Thus, the voltage rating of “a3a4” coil should be kept at the rated phase voltage to obtain balanced and equal voltages.

$$\begin{bmatrix} V_a \\ V_b \\ V_c \\ V_d \\ V_e \\ V_f \\ V_g \end{bmatrix} = \frac{1}{\sin(\pi/3)} \times \begin{bmatrix} \sin(\frac{\pi}{3}) & 0 & 0 \\ \sin(\frac{\pi}{21}) & 0 & -\sin(\frac{2\pi}{7}) \\ 0 & \sin(\frac{5\pi}{21}) & -\sin(\frac{2\pi}{21}) \\ -\sin(\frac{4\pi}{21}) & \sin(\frac{\pi}{7}) & 0 \\ -\sin(\frac{4\pi}{21}) & 0 & \sin(\frac{\pi}{7}) \\ 0 & -\sin(\frac{2\pi}{21}) & \sin(\frac{5\pi}{21}) \\ \sin(\frac{\pi}{21}) & -\sin(\frac{2\pi}{7}) & 0 \end{bmatrix} \begin{bmatrix} V_x \\ V_y \\ V_z \end{bmatrix}. \quad (1c)$$

Where the three-phase voltages (line-to-neutral) are defined as below

$$V_j = V_{\max} \sin \left(\omega t - n \frac{\pi}{3} \right),$$

$$j = x, y, z, \text{ and } n = 0, 2, 4, \text{ respectively,} \quad (2)$$

$$V_k = V_{\max} \sin \left(\omega t - n \frac{\pi}{7} \right), \quad k = a, b, c, d, e, f, g,$$

$$\text{and } n = 0, 2, 4, 6, 8, 10, 12, \text{ respectively.} \quad (3)$$

Using (1c), a seven-phase output can be created from a three phase input supply. A general expression for an “n” phase system is derived and shown in (4)

$$V_r = [(-1)^a V_x \sin(\theta) + (-1)^b V_y \sin(\phi) + (-1)^c V_z \sin(\gamma)] \quad (4)$$

where r = phase number = 1,2,3,.....,n;

$$V_x = 0 \text{ when } \left(\frac{\pi}{3} \leq \frac{2(r-1)\pi}{n} \leq \frac{2\pi}{3} \right)$$

$$\text{or } \left(\frac{4\pi}{3} \leq \frac{2(r-1)\pi}{n} \leq \frac{5\pi}{3} \right) \quad (4a)$$

where n = number of phases in the system

$$V_y = 0 \text{ when } \left(0 \leq \frac{2(r-1)\pi}{n} \leq \frac{\pi}{3} \right)$$

$$\text{or } \left(\pi \leq \frac{2(r-1)\pi}{n} \leq \frac{4\pi}{3} \right) \quad (4b)$$

$$V_z = 0 \text{ when } \left(\frac{2\pi}{3} \leq \frac{2(r-1)\pi}{n} \leq \pi \right)$$

$$\text{or } \left(\frac{5\pi}{3} \leq \frac{2(r-1)\pi}{n} \leq 2\pi \right) \quad (4c)$$

Since a transformer works as a two-port network, the reverse connection is also possible, i.e., if a seven-phase supply is given at the input the output can be three phase can also be obtained. This is important if electric power is generated using a seven-phase alternator and the supply to the grid is given as three phase. To obtain three-phase outputs from a seven-phase input supply, following relations hold good

$$\begin{bmatrix} V_x \\ V_y \\ V_z \end{bmatrix} = \frac{1}{\sin(\pi/7)} \begin{bmatrix} \sin(\frac{\pi}{7}) & 0 & 0 \\ 0 & 0 & -\sin(\frac{2\pi}{21}) \\ 0 & \sin(\frac{\pi}{21}) & 0 \\ 0 & 0 & 0 \\ 0 & 0 & \sin(\frac{\pi}{21}) \\ 0 & 0 & 0 \\ 0 & -\sin(\frac{2\pi}{21}) & 0 \end{bmatrix}^t$$

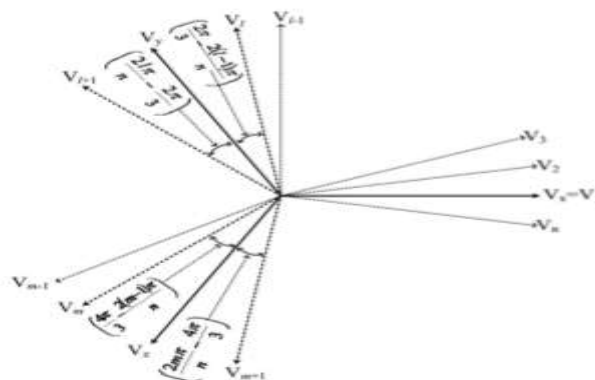

Fig.4. General Phasor diagram for three-phase system from “n” phase system

III. METHODOLOGY

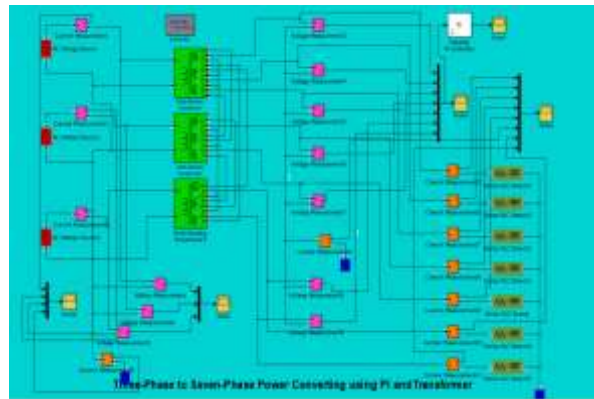

Figure 3.1: Blocks used in Simulink for three phase to seven phase power conversion using PI controller and transformer

The above figure shows the blocks used for the conversion in MATLAB Simulink. Three phase supply is converted to seven phase output supply by using multi winding transformer. This multi winding transformer works as a step up transformer for conversion of three phase to seven phase. The converted signal then goes to the Proportional Integral (P.I.) control loop where it gets multiplied by the proportional and integral constants. The output of the P.I. control is a power value with reduced noises and error. To measure the voltage and current the measuring blocks are used respectively with a RLC load branch connected in series.

IV. RESULT

Following are the seven phase results obtained after the conversion:

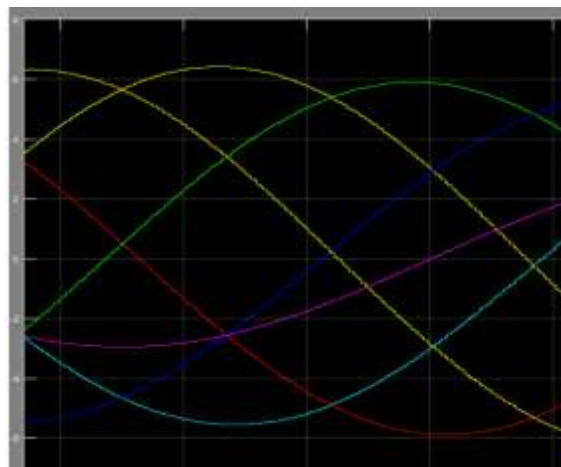

Figure 4.1: Seven Phase Voltage Signals

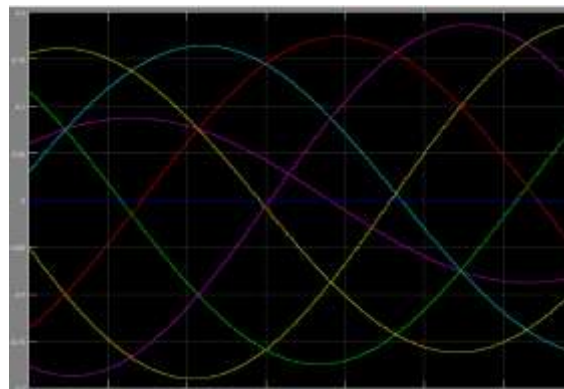

Figure 4.2: Seven Phase Current Signals

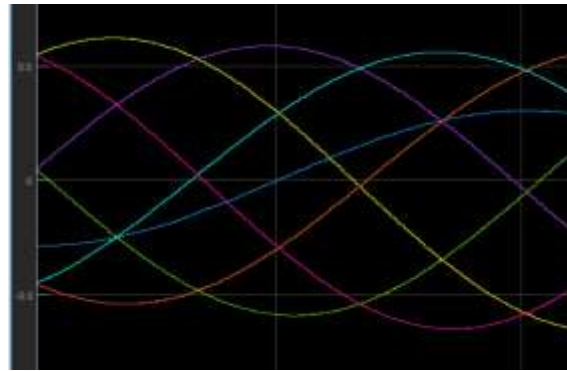

Figure 4.3: Power Output of the PI Controller

FFT Analysis:

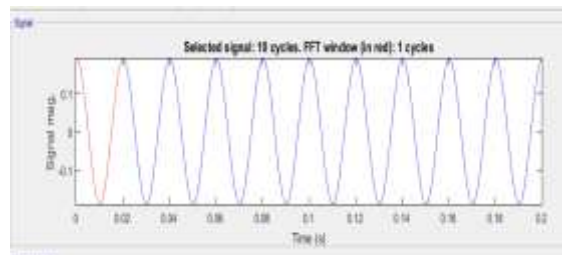

Figure 4.4: Input Signal for FFT Analysis

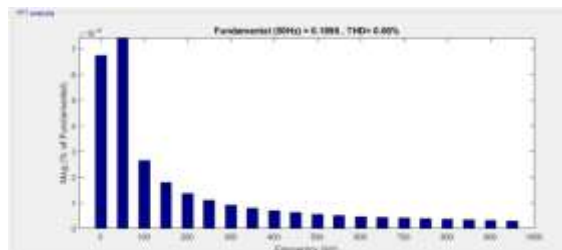

Figure 4.5: Fundamental Frequencies

Hysteresis:

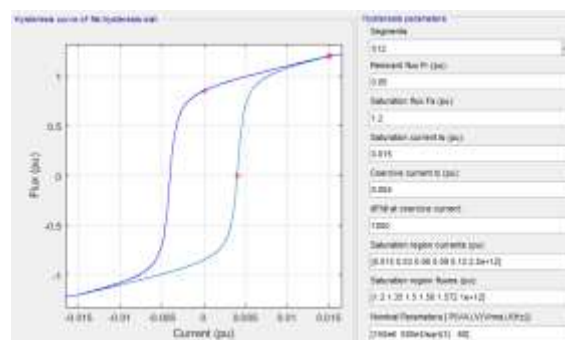

Figure 4.6: Hysteresis curve with parameters

V. CONCLUSION

The fixed three-phase voltage and fixed frequency in the grid power supply is transformed to fixed voltage and fixed frequency seven-phase output supply. This paper proposes a transformer connection scheme to obtain a balanced three-to-seven-phase supply. A three phase transformer input is converted to seven phase output to drive different loads.

REFERENCES

[1]D. Basic, J. G. Zhu, and G. Boardman, "Transient performance study of brushless doubly fed twin stator generator," IEEE Trans. Energy Convers., vol. 18, no. 3, pp. 400-408, Sep. 2003.

- [2] G.K. Singh, "Self excited induction generator research—A survey," *Elect. Power Syst. Res.*, vol. 69, pp. 107–114, 2004.
- [3] O. Ojo and I. E. Davidson, "PWM-VSI inverter-assisted stand-alone dual stator winding induction generator," *IEEE Trans. Energy Convers.*, vol. 36, no. 6, pp. 1604–1611, Nov./Dec. 2000.
- [4] G. K. Singh, K. B. Yadav, and R. P Sani, "Analysis of saturated multiphase (six-phase) self excited induction generator," *Int J. Emerg. Electr. Power Syst.*, vol. 7, no. 2, article 5, Sep. 2006.
- [5] G. K. Singh, "Modelling and experimental analysis of a self excited sixphase induction generator for stand alone renewable energy generation," *Renewable Energy*, vol. 33, no. 7, pp. 1605–162, Jul. 2008.
- [6] J.R.StewartandD.D.Wilson,"Highphaseordertransmission—Afeasibility analysis—Part-I: Steady state considerations," *IEEE Trans. Power App. Syst.*, vol. PAS-97, no. 6, pp. 2300–2307, Nov. 1978.
- [7] J.R.StewartandD.D.Wilson,"Highphaseordertransmission-Afeasibility analysis—Part-II: Over voltages and insulation requirements," *IEEE Trans. Power App. Syst.*, vol. PAS-97, no. 6, pp. 2308–2317, Nov. 1978.
- [8] J. R. Stewart, E. Kallaur, and J. S. Grant, "Economics of EHV high phase order transmission," *IEEE Trans. Power App. Syst.*, vol. PAS103, no. 11, pp. 3386–3392, Nov. 1984. [9] S.N. Tewari, G.K. Singh, and A.B. Saroor, "Multi phase Power transmission research—A survey," *Electr. Power Syst. Res.*, vol. 24, pp. 207–215, 1992.
- [10] C.M. Portel and M.C. Tavares, "Six-phase transmission line-propagation characteristics and new three-phase representation," *IEEE Trans. Power Delivery*, vol. 18, no. 3, pp. 1470–1483, Jul. 1993.
- [11] T.L.Landers,R.J.Richeda,E.Krizanskas,J.R.Stewart,andR.A.Brown, "High phase order economics: Constructing a new transmission line," *IEEE Trans. Power Delivery*, vol. 13, no. 4, pp. 1521–1526, Oct. 1998.
- [12] J. M. Arroyo and A. J. Conejo, "Optimal response of power generators to energy, AGC, and reserve pool based markets," *IEEE Power Eng. Rev.*, vol. 22, no. 4, pp. 76–77, Apr. 2002.
- [13] M. A. Abbas, R. Chirsten, and T. M. Jahns, "Six-phase voltage source inverter driven induction motor," *IEEE Trans. Ind. Appl.*, vol. IA-20, no. 5, pp. 1251–1259, Sep./Oct. 1984. [14] K.N.Pavithran, R. Parimelalagan, and M.R. Krsihnamurthy, "Studies on inverter fed five-phase induction motor drive," *IEEE Trans. Power Elect.*, vol. 3, no. 2, pp. 224–235, Apr. 1988.
- [15] G. K. Singh, "Multi-phase induction machine drive research—A survey," *Electr. Power Syst. Res.*, vol. 61, pp. 139–147, 2002.
- [16] R. Bojoi, F. Farina, F. Profumo, and A. Tenconi, "Dual-three phase induction machine drives control—A survey," *IEEE J. Trans. Ind. Appl.*, vol. 126, no. 4, pp. 420–429, 2006.
- [17] E. Levi, R. Bojoi, F. Profumo, H. A. Toliyat, and S. Williamson, "Multiphase induction motor drives—A technology status review," *IET Electr. Power Appl.*, vol. 1, no. 4, pp. 489–516, Jul. 2007.
- [18] E. Levi, "Multiphase electric machines for variable-speed applications," *IEEE Trans Ind. Elect.*, vol. 55, no. 5, pp. 1893–1909, May 2008.
- [19] A. Iqbal and E. Levi, "Space vector PWM techniques for sinusoidal output voltage generation with a five-phase voltage source inverter," *Electr. Power Compon. Syst.*, vol. 34, no. 2, pp. 119–140, 2006. [20] D. Dujic, M. Jones, and E. Levi, "Generalised space vector PWM for sinusoidal output voltage generation with multiphase voltage source inverter," *Int. J. Ind. Elect. Drives*, vol. 1, no. 1, pp. 1–13, 2009. [21] M. J. Duran, F. Salas, and M. R. Arahal, "Bifurcation analysis of five phase induction motor drives with third harmonic injection," *IEEE Trans. Ind. Elect.*, vol. 55, no. 5, pp. 2006–2014, May 2008.
- [22] M. R. Arahal and M. J. Duran, "PI tuning of five-phase drives with third harmonic injection," *Control Engg. Pract.*, vol. 17, no. 7, pp. 787–797, Jul. 2009.
- [23] D. Dujic, M. Jones, and E. Levi, "Analysis of output current ripple rms in multiphase drives using space vector approach," *IEEE Trans. Power Elect.*, vol. 24, no. 8, pp. 1926–1938, Aug. 2009.
- [24] M. Correa, C. R. da Silva, H. Razik, C. B. Jacobina, and E. da Silva, "Independent voltage control for series-connected six- and three-phase Induction machines," *IEEE Trans. Ind. Appl.*, vol. 45, no. 4, pp. 1286–1293, Jul./Aug. 2009.
- [25] A. Iqbal, S. Moinuddin, M. R. Khan, S. K. M. Ahmed, and H. Abu-Rub, "A novel three-phase to five-phase transformation using special transformer connection," *IEEE Trans. Power Delivery*, vol. 25, no. 3, pp. 1637–1644, Jun. 20