

Complete Industrial Solution for Automation in Temperature and Humidity Monitoring and controlling using LabVIEW

P.G. student Urmila More, Prof.D.D. Dighe

Department of Electronics & Telecomm Engineering Matoshri college of engineering and research center,
Nashik, India

ABSTRACT- Industries like biomedical, agricultural and pharmaceutical which forms backbone of countries economy. The monitoring of humidity and temperature is important part in such industries [1]. The controlled environment forms foremost criteria in all of the above industries. Small deviation in the environmental conditions can cause heavy financial losses because of alterations in productivity in the pharmaceutical and agricultural industries. The technological advancements in various field including instrumentation is kept in mind and care was taken to utilize it. This improves the functionality of the device proposed.

The proposed system provides a solution for similar problem. The system can monitor the temperature humidity and other parameters of different parts of industry as well as at different stages of processing and is controlled by LabView software platform. Also the system can perform different functions such as user login facility for authenticate user to enter in system, easy reconfiguration i.e. to update setpoints of data, alarm facility if the parameters goes beyond specified setpoints, and data logging facility and alarm logging facility for further analysis, also the real time graphs of the system are monitored. All these facilities make it ideal for industrial applications.

Keywords - monitoring; controlling; automation; temperature; humidity; labView;

Introduction

Electronics assembly units work under a controlled environment with temperature in the range of 16C-28C and relative humidity in the range of 35% -65%. In the SMT applications and soldering process [1] lack of control over temperature and humidity may cause certain defects. Some ESD issues as well as due to low humidity improper solder joints can be caused. Similarly, in high humidity Surface mount devices may experience popcorn defects[2]. Similarly, variations in temperature causes defects like improper solder joints, bridging and extra oxidation of boards, solder and components. Looking at their importance, it is kept mandatory in industries to monitor the above environmental parameters which when done manually is overlooked due to tediousness.

The work has been done in this regard but with lesser consideration on the application side and deployment

in industrial environment. The temperature and humidity detector mentioned in [3] does not provide for remote wireless monitoring. In [4], the authors have presented a digital temperature measurement system using labView with automatic control as well.

Objectives

The objective of this project is to design a temperature and humidity monitoring system that can take measurements of the temperature, humidity and save them on a server so that this data may be accessed from anywhere via the Internet. We are using LabView as software platform for this system design which provides run time values of temperature and humidity along with its graphs, also the lower and upper limits for temperature above which indication is provided. We can analyze the previous result with current values to take corrective action.

Design Methodology

Sensing the temperature and humidity and level in industries has been important over the centuries. In this system we use temperature sensor and humidity sensor for measuring the temperature and humidity of different floors of industry. labVIEW is chosen as the platform for development of this system as it provides the ease of graphical programming and is very useful for building an efficient user interface through various designs. Moreover, most importantly, the availability of large no. of toolkits with hardware support for almost all kinds of applications make it an ideal software platform for developing these kind of industrial solutions. Also it helps to relieve the developer of the low level hardware and software issues experienced during design so that he/she may lay more time on the bottlenecks related to application [6].

Implementation

The implementation of the system is done using hardware as well as software.

Hardware:

Here we have used four input channels for sensing the input data, out of which two channels are implemented by

hardware and remaining two channels are only simulated in labVIEW. Each channel have two nodes.

- These four channels are as follows:

Channel 0:

Node 1: temperature sensing node using LM35.

Node 2: humidity sensing node using DHT 11.

Channel 1:

Node 1: temperature sensing node using LM35.

Node 2: level sensing node using ultrasonic level sensor HCSR04.

Channel 2:

Node 1: Ph sensing node.

Node 2: pressure sensing node.

Channel 3:

Node 1: moisture sensing node.

Node 2: current sensing node.

- Data Acquisition Card:

Data acquisition card is designed using pic microcontroller 16F877A. LabVIEW is very powerful when it comes to creating DAQ applications. Set of different VIs is provided by LabVIEW so that user can configure the system, acquire data from, and send data to DAQ devices.

At the input to DAQ sensors are used which will sense input parameters, these are converted to digital signals and given to wireless transceiver pair which will compare the actual values sensed by sensors to their limits put in software. After comparison if the signal levels are beyond specified values controlled action is taken. For that control signal is given by LabView to wireless transceiver and then to DAQ which will take the control action. If the limits are at boundary then alarms are generated and alarm log table is also created along with date and time. In this way DAQ is used to collect the data and to take a control action.

- Wireless Transceiver:

Wireless Transceivers are used for wireless communication between the actual hardware platform of industries and LabVIEW i.e. user platform. For wireless communication the media of communication is air. The most common wireless technologies use radio.

We can use Zigbee, Bluetooth, Wi-Fi, GSM as wireless transceiver. Here ATCC2500 is used. The CC2500 is a low-

cost 2.4 GHz transceiver designed for very low-power wireless applications. The circuit is intended for the 2400-2483.5 MHz ISM (Industrial, Scientific and Medical) and SRD (Short Range Device) frequency band.

Block Diagram of proposed system:

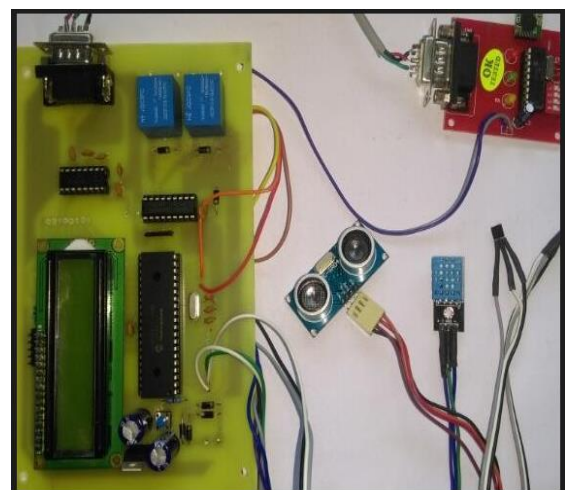
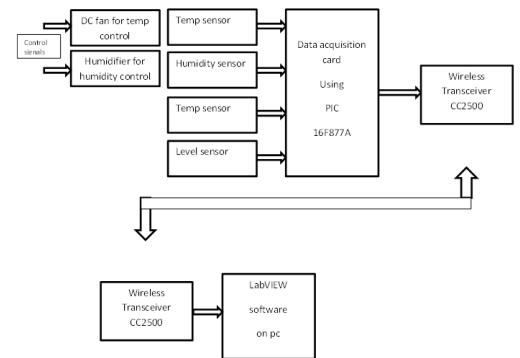

Interfacing of different sensors to the microcontroller

Temperature sensor

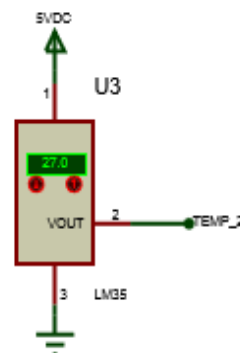

Humidity sensor

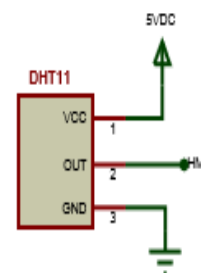

Ultrasonic level sensor

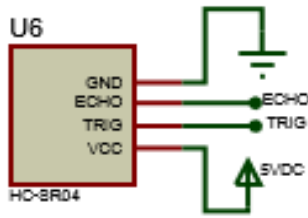

1.Insert- used for creating data log table and alarm log table.

2.Update- used for updating setpoints of different parameters.

3.Select- Used to read alarm limits.

Front panel of LabView shows following:



Setting consists of settings of serial communication along with set points of all the channels.

Interfacing with PIC 16F877A

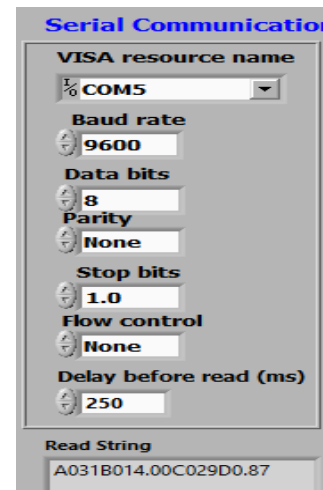
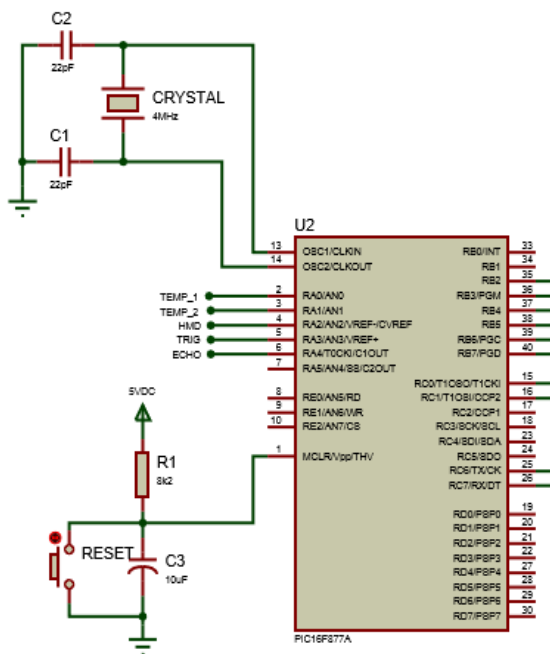

Software:

labVIEW, is the national instruments software and here version 2011 is used. LabView has two panels front panel for user and block diagram to perform actual program functions. Along with LabView VISA driver and signal processing toolkits are also installed. For proper functioning of system and to avoid complications in programming different sub VI are created just like subroutines. LabView Performs following functions

1. Read the string of input
2. Extract the channel information
3. Plot the real time graphs of parameters
4. Read setpoints/ update setpoints
5. Generate alarm and create alarm log table
6. Create a data log table

System uses following database handling queries

Parameters consists of levels of inputs along with their control actions as ON/OFF.

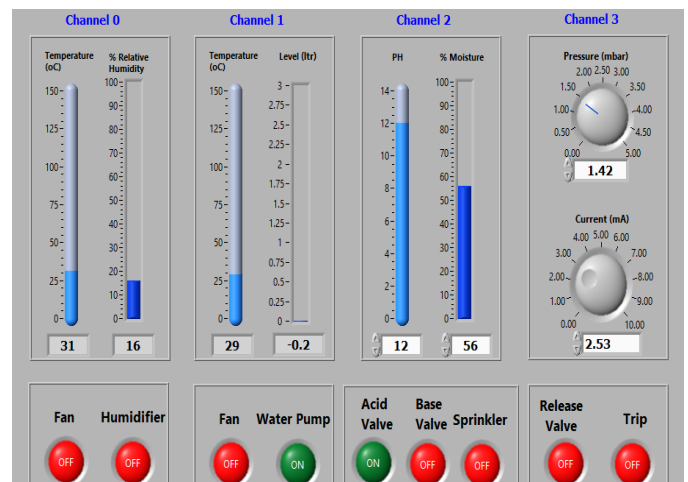

Trends shows run time values of input graphically.

Datalog creates database of input values along with date and time.

Datalog								
Timestamp	CH0 Temperature	CH0 Humidity	CH1 Temperature	CH1 Level	CH2 PH	CH2 Moisture	CH3 Pressure	CH3 Current
11/05/2017 2:24:22 AM	31	14	31	0.87	8	56	1.42	2.53
11/05/2017 2:24:19 AM	33	14	29	0.87	8	56	1.42	2.53
11/05/2017 2:24:05 AM	33	14	29	0.87	8	56	1.42	2.53
11/05/2017 2:24:02 AM	33	14	31	0.87	8	56	1.42	2.53
11/05/2017 2:23:58 AM	33	14	29	0.87	8	56	1.42	2.53
11/05/2017 2:23:53 AM	33	14	29	0.87	8	56	1.42	2.53
11/05/2017 2:23:50 AM	33	14	31	0.87	8	56	1.42	2.53
11/05/2017 2:23:47 AM	35	14	31	0.87	8	56	1.42	2.53
11/05/2017 2:23:42 AM	37	14	29	0.87	8	56	1.42	2.53
11/05/2017 2:23:37 AM	37	14	29	0.87	8	56	1.42	2.53
11/05/2017 2:23:32 AM	39	14	31	0.87	8	56	1.42	2.53
11/05/2017 2:23:27 AM	43	14	31	0.87	8	56	1.42	2.53
11/05/2017 2:23:21 AM	47	14	29	0.87	8	56	1.42	2.53
11/05/2017 2:23:15 AM	58	14	31	0.87	8	56	1.42	2.53
11/05/2017 2:23:08 AM	54	14	31	0.87	8	56	1.42	2.53

Similarly alarm creates warnings and alarming.

Alarms		
Timestamp	Category	Description
11/05/2017 2:24:22 AM	warning	CH0 Humidity Below Low Limit
11/05/2017 2:24:04 AM	warning	CH0 Humidity Below Low Limit
11/05/2017 2:24:01 AM	warning	CH0 Humidity Below Low Limit
11/05/2017 2:23:58 AM	warning	CH0 Humidity Below Low Limit
11/05/2017 2:23:53 AM	warning	CH0 Humidity Below Low Limit
11/05/2017 2:23:50 AM	alarm	CH0 Humidity Below Low-Low Limit
11/05/2017 2:23:46 AM	warning	CH0 Humidity Below Low Limit

Conclusion

The proposed system not only automates the monitoring and controlling process of temperature and humidity but also the system can perform different functions such as user login facility for authenticate user to enter in system, easy reconfiguration i.e. to update setpoints of data, alarm facility if the parameters goes beyond specified setpoints, and data logging facility and alarm logging facility for further analysis, also the real time graphs of the system are monitored. Another big advantage of such a system is customizing it for control applications also according to the needs of the user. This paves way to work out ways to automate the process of taking counter acting measures in case the temperature and humidity goes out of the limits.

VI. Acknowledgement

I would like to thank to all the people who directly and indirectly help for completion of this dissertation.

References

- [1] Circuitnet, "What should be the average temperature and humidity level in an electronic assembly facility", Ask the Experts.
- [2] Technical Brief, "Guidelines for handling and Processing Moisture Sensitive Surface Mount Devices (SMDs)", Intersil.
- [3] Yang Jingwei , Sun Rongxia, Ji Na, Li Lei, Chen Zhangle, "The Portable Temperature and Humidity Monitor Based on Intelligent Sensor," Proceedings of. The 1st International Conference on Information Science and Engineering (ICISE2009)

- [3] Wenlian Li, Sun Yang Li and Fan Xiao, "The Design and Implementation of Digital Temperature Measurement and Automatic Control System," Proceedings of. 2010 International Conference on Computer Application and System Modeling (ICCA SM 2010).