

Design & optimization of lever quadrant assembly for light transport aircraft

Avinash Kodoli¹, Prof Nagraj Kelageri²

¹Post Graduate Student, Department of Mechanical Engineering, KLEMSSCET, Karnataka, India

²Professor, Department of Mechanical Engineering, KLEMSSCET, Karnataka, India

Abstract - Lever and Quadrant assembly are extensively used in transport aircraft compared to fighter aircraft. The lever quadrant assembly for rudder and elevator is located at rear fuselage side by side. The cables coming from front fuselage is fastened to the lugs of lever quadrant assembly. Lever is connected to the control surface through push pull rod and bell crank. Each quadrant assembly there are total three quadrants connected to a shaft. The shaft is connected to a bracket which in turn is fixed at bulk head. Out of three quadrants, two are connected via cable to the front fuselage. Out of these two quadrants one is main and the other one is standby. The third one is connected to the autopilot.

The lever quadrant assembly is checked for strength requirement using linear static analysis and strength of material approach. If the stress level of lever quadrant assembly is found above ultimate stress of the material it is to be designed again. Then again it is to be checked for strength requirement using linear static analysis and strength of material approach. Optimization is to be carried out of the lever quadrant assembly to reduce mass by experimental method with the view of stress level intact and again it is to be checked for strength requirement using linear static analysis.

Key Words: lever, quadrant assembly, linear static analysis.

1. INTRODUCTION

Control is the action taken to make the aircraft follow any desired flight path. When an aircraft is said to be controllable, it means that the craft responds easily and promptly to the movement of the controls. Different control surfaces are used to control the aircraft about each of the three axes. Moving the control surfaces on an aircraft changes the airflow over the aircraft's surface. This in turn, creates changes in the balance of forces acting to keep the aircraft flying straight and level.

Quadrant is a control system component which is used to change direction of motion and which transmit motion to parts such as control rods, cables and torque tubes.

The present work is to design the lever quadrant assembly for rudder and elevator control system of a light transport aircraft. The lever quadrant assembly for rudder and elevator is located at rear fuselage side by side. The cables coming from front fuselage is fastened to the lugs of

lever quadrant assembly. Lever is connected to the control surface through push pull rod and bell crank.

1.1 Lever & Quadrant assembly

The proposed lever quadrant assembly for rudder and elevator control system is located at rear fuselage side by side as shown in fig. 1. The cables coming from front fuselage is fastened to the lugs of lever quadrant assembly. Lever is connected to the control surface through push pull rod and bell crank.

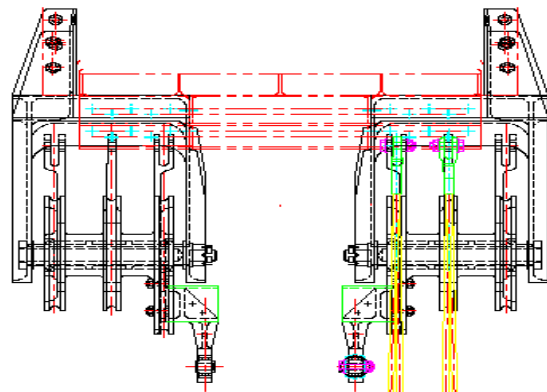

Fig -1.1: Location of component in aircraft

2 Objectives and Methodology

2.1 Problem Statement

Problem involves a single load step structural static analysis of the lever quadrant assembly. The central shaft of lever quadrant assembly is constrained around its entire circumference when the lever quadrant assembly is in critical position. Point load and pressure force is applied on quadrant and point load is applied on lever. The analysis is carried out for critical load case. The problem is lever is failing therefore modifying the design of lever and optimizing the weight.

Design load acting on both inboard and middle quadrant

$$= 411.75 \text{ kgf (4039.26 N)}$$

Design reaction force acting on lever

$$= 887.39 \text{ kgf (8705.29 N)}$$

2.2 Objectives

While redesigning the lever quadrant assembly the following aspects are taken as main objectives.

- i) The lever quadrant assembly is checked for strength requirement using linear static analysis,
- ii) If the stress level of assembly is found above ultimate stress of the material it is to be redesigned. Then again it is to be checked for strength requirement using linear static analysis and strength of material approach.
- iii) Optimization of mass by experimental method with the view of stress level intact and again it is to be checked for strength requirement using linear static analysis.

2.3 Methodology

This project is about the design and optimisation of lever quadrant assembly. In order to carry out this project following process stages has to be followed:

- 1) 3D modeling using CATIA.
- 2) Meshing with the help of Hyper Mesh.
- 3) Design calculations.
- 4) Analysis using NASTRAN.

2.4 2D model of proposed lever and quadrant assembly

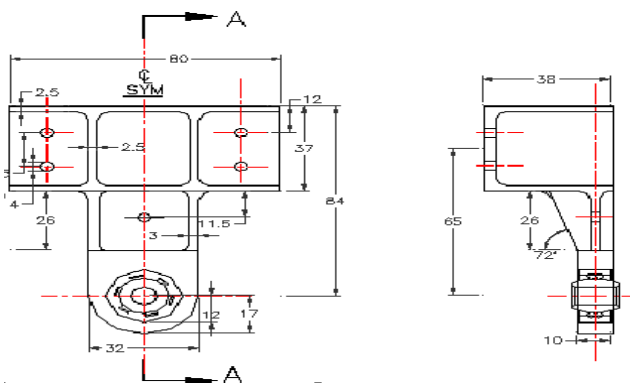

Fig -2.1: 2D model of lever.

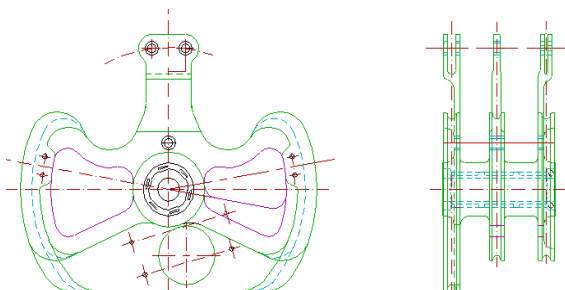

Fig -2.2: 2D model of quadrant assembly.

2.5 Material Properties

The lever and quadrant assembly is made of aluminum alloy. The material property is given in following table 2.1.

Table -2.1: Material property.

material	Young's modulus (kgf/mm ²) (N/mm ²)	Poisson's ratio	Density (kg/mm ³)	Yield stress (Kgf/mm ²) (N/mm ²)	Ultimate stress (Kgf/mm ²) (N/mm ²)
Aluminum 2024 T351	7500 73575	0.33	2.8e-5	33.74 330.98	46.39 455.08

2.6 3D model of proposed lever and quadrant assembly

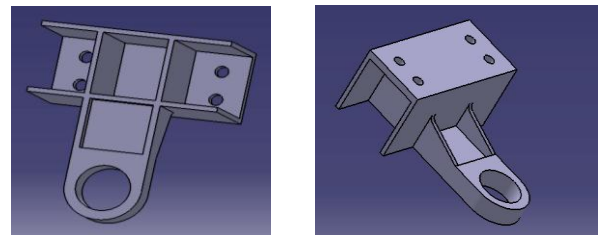

Fig -2.3: 3D model of lever.

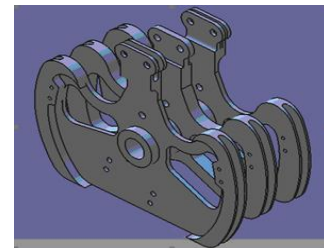

Fig -2.4: 3D model of quadrant assembly

2.7 Meshing

The surface model is imported in the hyper mesh tool. The geometry was cleaned up to remove the all free edges. Cleaned model is then used to develop a finite element mesh. Six noded hexahedral element is selected for meshing.



Fig -2.5: Meshed lever &quadrant assembly.

3 Analysis

The lever quadrant assembly is connected to a bracket with the help of a shaft and in turn the bracket is fixed to bulk head. The lever quadrant assembly can rotate about the shaft 16 degree either side. Hence this shaft acts as constraints. For the purpose of analysis the shaft hole is constrained at

critical position in all degrees of freedom. The fig. 4.18 shows constraints applied to the model.

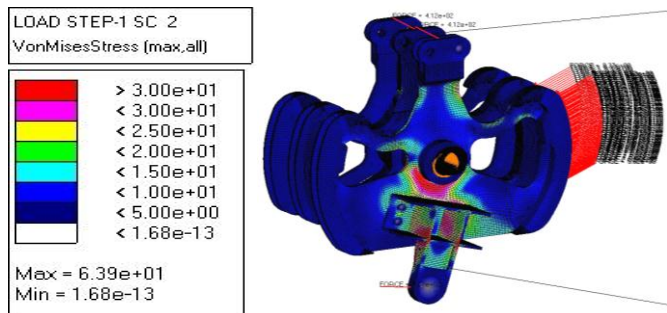

Fig -3.1: Stress diagram of lever quadrant assembly.

3.1 First Analysis of lever

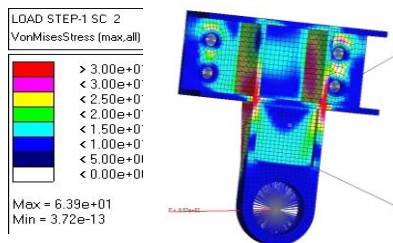

Fig -3.2: First analysis of lever.

We know ultimate tensile stress of aluminum is 46.39 kgf/mm^2 (455.08 N/mm^2). Hence the maximum stress level found in analysis for lever and quadrant assembly separately is much higher than ultimate stress of aluminum. Therefore design is to be modified so that the stress level can come down below the ultimate stress of aluminum.

3.2 Second Analysis of Redesigned Lever

The changed dimensions of model for second analysis are as follows :

- 1) Distance between two mid walls = 34.537 mm
- 2) Thickness of each mid wall = 3 mm .
- 3) Lever cross sectional area = 224.523 mm^2
- 4) Shape of lever = Trapezoidal

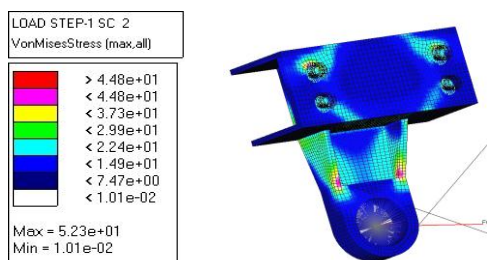

Fig -3.3: Second analysis of lever.

Comment on second analysis :

The above modification has brought down the stress level from 63.9 kgf/mm^2 (626.85 N/mm^2) to 52.3 kgf/mm^2 (513.06 N/mm^2). But steel it is higher than yield stress of aluminum. Hence need to modify the model to bring the stress level down. But volume is increased from 45349.137 mm^3 to 47114.139 mm^3 . Also mass has increased from $1.270e-01 \text{ kg}$ to $1.319e-01 \text{ kg}$. We shall take care of these two things later.

3.3 Third Analysis of Redesigned Lever

As stress concentration exists at sharp corner of side wall and maximum stress exists there, hence effort is being made to give a curve shape to reduce the stress level.

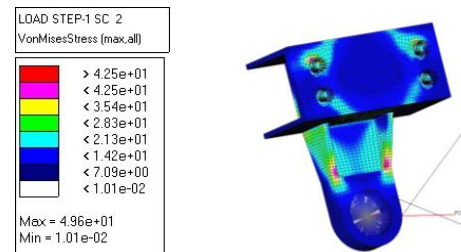

Fig -3.4: Third analysis of lever.

Comment on third analysis :

The above modification has brought down the stress level from 52.3 kgf/mm^2 (513.06 N/mm^2) to 49.6 kgf/mm^2 (486.57 N/mm^2). Hence need to modify the model to bring the stress level down. But volume is slightly increased from 47114.139 mm^3 to 47129.335 mm^3 . Also mass has increased from $1.319e-1 \text{ kg}$ to $1.320e-1 \text{ kg}$. We shall take care of these two things later.

3.4 Fourth Analysis of Redesigned Lever

In third analysis we have seen that still maximum stress occur at bottom side wall of lever. To remove this maximum stress, shape of lever is made hexagonal instead of trapezoidal with one side curved.

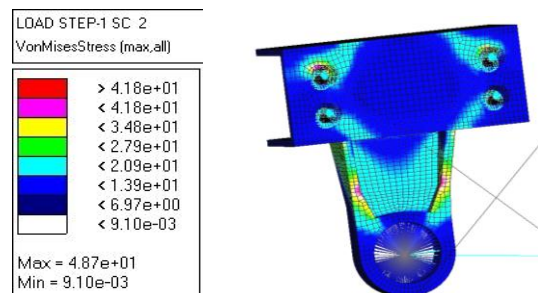

Fig -3.5: Fourth analysis of lever.

Comment on fourth analysis :

The above modification has brought down the stress level from 49.6 kgf/mm² (486.57 N/mm²) to 48.7 kgf/mm² (477.74 N/mm²). But this analysis shows that maximum stress region has shifted from side wall bottom portion to bolt region. At side wall stress is 44.059 kgf/mm² (432.21 N/mm²). Also the analysis shows that volume is decreased from 47129.335 mm³ to 46378.998 mm³. Mass has decreased from 1.320e-01 kg to 1.299e-01 kg.

3.5 Fifth Analysis of Redesigned Lever

In the fourth analysis it is found that stress level at the back of side wall is 44.059 kgf/mm² (432.218 N/mm²). This stress has occurred due to change of section or sharp corner. To remove it little extra material is added where change of section has taken place. Hence the rear of side wall is made straight and change of section take place at the rear bottom of side wall.

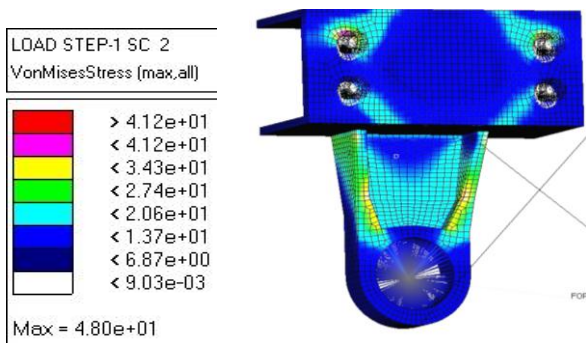

Fig -3.6: Fifth analysis of lever.

Comment on fifth analysis :

The above modification has brought down the stress level from 48.7 kgf/mm² (477.74 N/mm²) to 48.0 kgf/mm² (470.88 N/mm²). But steel it is higher than yield stress of aluminum. Analysis shows that maximum stress region is near to the bolt. The side wall stress has come down from 44.059 kgf/mm² (432.21N/mm²) to 35.72 kgf/mm² (350.41 N/mm²). Also the analysis shows that volume is increased from to 46378.998 mm³ to 46550.431 mm³ and mass has increased from 1.299e-01 kg to 1.303e-01 kg.

3.6 Sixth Analysis of Redesigned Lever

In Sixth analysis extra material is removed which we added earlier. Idea is to check up the stress level whether it remain same or increases after removing material.

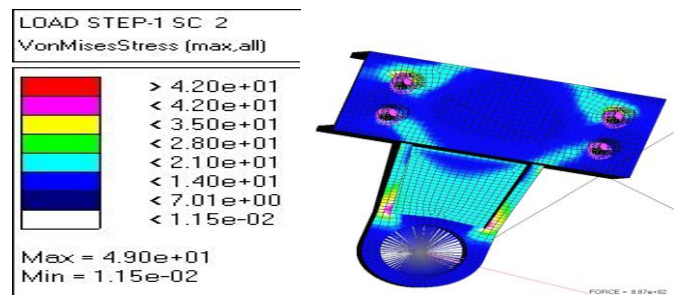

Fig -3.7: Sixth analysis of lever.

Comment on sixth analysis :

The above modification has increased the stress level from 48.0kgf/mm² (470.88 N/mm²) to 49 kgf/mm² (480.69 N/mm²) which occur near to bolt region which is more than ultimate stress of aluminum as shown in fig. The analysis shows volume has decreased from 46550.431mm³ to 46245.557 mm³ and mass has decreased from 1.303e-01 kg to 1.295e-01 kg. Though volume and mass has decreased but removal of material has increased the stress level. Hence the removal of material is unjustified. Therefore for further analysis fifth analysis model is to be considered.

3.7 Seventh Analysis of Redesigned Lever

At first from fifth analysis model of lever, unwanted material is removed to reduce weight of the lever. In the present lever model the mass is reduced from 1.303e-01 kg to 1.173e-01 kg and volume is reduced from 46245.557 mm³ to 41898.476 mm³.

Now this lever is attached to quadrant assembly with the help of four bolts and analysis is to be carried out to check the maximum stress level.

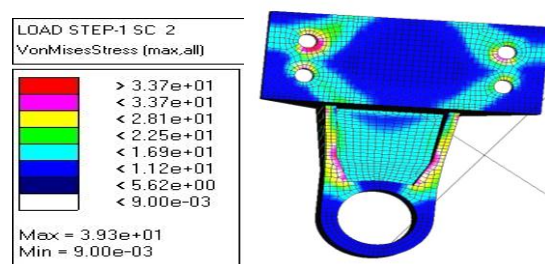

Fig -3.8: Seventh analysis of lever.

Comment on seventh analysis :

The analysis shows that maximum stress level has shifted from bolt region to the back of side wall where change of section takes place as shown in fig. 4.36. Its value is 39.5 kgf/mm² (387.49 N/mm²). Also analysis shows, in the bolt region maximum stress value has come down from 48.0 kgf/mm² (470.88 N/mm²) to 38.98 kgf/mm² (382.39 N/mm²).

Hence the design is safe.

4 Mass Reduction of Lever

Once we have achieved safe design of lever next effort is being made to reduce mass of lever by keeping the stress level intact. The present mass of lever is 1.173×10^{-1} kg and volume is 41892.091 mm^3 .

4.1 First experimental analysis

In the first experiment two holes of diameter 20 mm each is made as shown in fig. 4.37. Both holes are made equal size for easy of manufacturing. Now it can be seen through analysis the maximum stress level after holes are made.

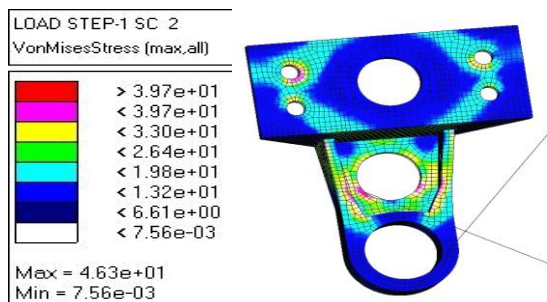

Fig -4.1: First experimental analysis.

Comment on first experimental analysis :

The first experiment shows that maximum stress is 46.3 kgf/mm^2 (454.20 N/mm^2) and it occurs at the edge of middle hole as shown in fig. 4.38. This stress level is more than ultimate stress of aluminum. The stress level surrounding the top hole is within limit. The mass of the lever is reduced from $1.173 \times 10^{-1} \text{ kg}$ to $1.112 \times 10^{-1} \text{ kg}$ and volume is reduced from 41892.091 mm^3 to 39727.945 mm^3 . Hence middle hole need to modify by reducing the diameter of hole to reduce stress level.

4.2 Second experimental analysis

In second experiment diameter of middle hole is reduced from 20 mm to 16 mm as shown in fig. 4.2.

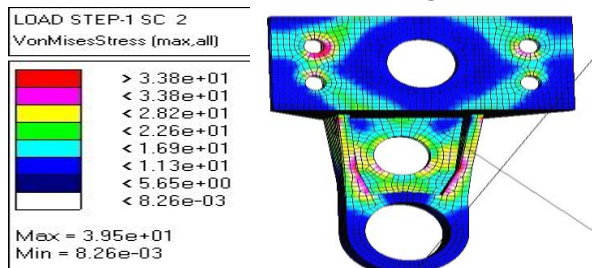

Fig -4.2: Second experimental analysis of lever.

Comment on second experimental analysis :

The second experiment shows that maximum stress is 39.5 kgf/mm^2 (387.49 N/mm^2) and it occurs near to bolt hole as shown in fig. 4.40. This stress level is less than ultimate

stress of aluminum. The stress level surrounding the middle hole is within limit. Hence reduction of diameter of hole is justified. The mass of the lever is increased from $1.112 \times 10^{-1} \text{ kg}$ to $1.122 \times 10^{-1} \text{ kg}$ and volume has increased from 39727.945 mm^3 to 40062.194 mm^3 .

4.3 Variation of stress, mass & volume of lever

The following table 4.1 shows the complete details of experimental results of lever stress, mass, volume.

Table -4.1: Summary of variation of stress, mass and volume of lever throughout project work.

Number of Analysis / Experiment	Stress		Mass (Kg)	% Mass Change	volume (mm ³)
	(kg/mm ²)	(N/mm ²)			
	max	min			
Analysis-1	63.9	3.72×10^{-13}	1.27×10^{-1}	-----	45349.137
	626.85	36.49×10^{-13}			
Analysis-2	52.3	1.01×10^{-3}	1.319×10^{-1}	3.8582677	47114.139
	513.06	9.90×10^{-2}			
Analysis-3	49.6	1.01×10^{-3}	1.320×10^{-1}	0.075815	47129.335
	486.57	9.90×10^{-2}			
Analysis-4	48.7	9.10×10^{-3}	1.299×10^{-1}	-1.590909	46378.998
	477.74	89.27×10^{-3}			
Analysis-5	48	9.03×10^{-3}	1.303×10^{-1}	0.3079292	46550.431
	470.88	88.58×10^{-3}			
Analysis-6	49	1.15×10^{-2}	1.295×10^{-1}	-0.613968	46245.557
	480.69	11.28×10^{-2}			
Analysis-7	39.3	9.00×10^{-3}	1.173×10^{-1}	-9.420849	41898.476
	387.49	88.29×10^{-3}			
Experiment-1	46.3	7.56×10^{-3}	1.112×10^{-1}	-5.200341	39727.945
	454.20	74.16×10^{-3}			
Experiment-2	39.5	8.26×10^{-3}	1.122×10^{-1}	0.8992806	40062.194
	387.49	81.03×10^{-3}			

4.4 Comparison of result

The following table 4.2 shows the analytical and theoretical results.

Table -4.2: comparison of results

Distance from point load on lever	Analytical Stress N/mm ²	Theoretical Stress N/mm ²	Remark
25mm	221.7	149.93	Safe
46.667mm	155	164.758	Safe

The above table shows that the design of lever is safe. The overall percentage of mass is reduced by 4.34 %.

5 Modification on design of quadrant assembly

The quadrant is redesigned based on stress level. The following analysis gives the information of modification of quadrant assembly

5.1 First analysis of quadrant assembly

The following fig. 5.1 shows the results of first analysis of quadrant assembly.

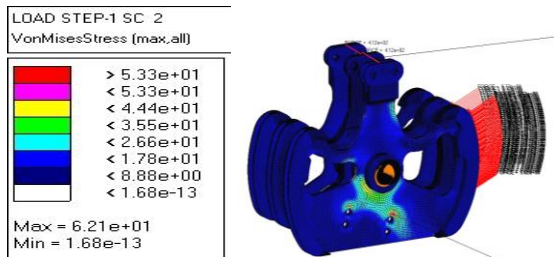

Fig -5.1: First analysis of quadrant assembly.

Comment on first analysis :

It is found that maximum stress in quadrant assembly occurs near to bolt hole and its value is 62.1 kgf/mm². Hence modification is to be carried out to bolt surrounding so as to bring down stress level below the ultimate stress of aluminum.

5.2 Second analysis of quadrant assembly

The model of quadrant the addition of extra material at the surrounding of bolt hole. The following fig. 5.2 shows the second analysis.

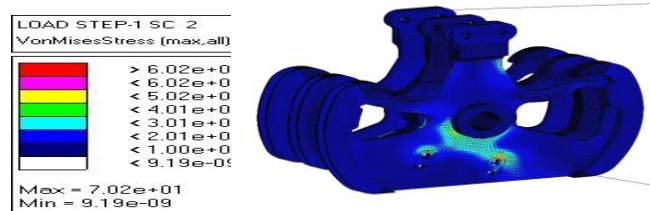

Fig -5.2: Second analysis of quadrant assembly.

Comment on second analysis :

In second analysis the stress level has increased from 62.1 kgf/mm² (609.201 N/mm²) to 70.2 kgf/mm² (688.662 N/mm²). The model for second analysis has failed to reduce the stress level.

5.3 Third analysis of quadrant assembly

To reduce the stress level fillet is added surrounding the extra material. The following fig. 5.3 shows the second analysis.

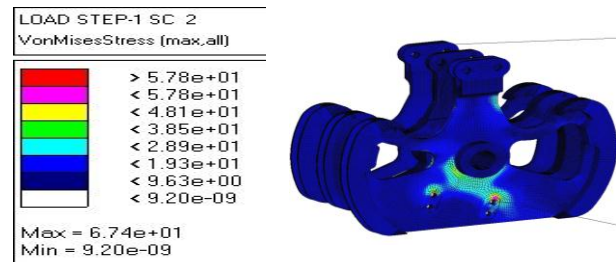

Fig -5.3: Third analysis of quadrant assembly.

Comment on third analysis :

In third analysis the stress level has come down from 70.2 kgf/mm² (688.622 N/mm²) to 67.4 kgf/mm² (661.194 N/mm²). The location of maximum stress is at bolt region. Volume has increased from 655056.403 mm³ to 655273.141 mm³ and mass has increased from 1.834 kg to 1.8354 kg. Hence addition of extra fillet material is justified. But still the maximum stress level is more than ultimate stress of aluminum. Hence further modification is required.

5.4 Forth analysis of quadrant assembly

Extra material is added at the back side of inner quadrant along with fillet material and in both sides more material is added at upper hole and less material is added at lower hole. The following fig. 5.4 shows the second analysis.

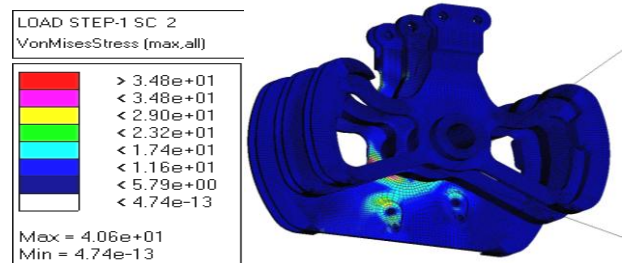

Fig -5.4: Forth analysis of quadrant assembly.

Comment on forth analysis :

The analysis shows that stress level has come down below the ultimate tensile stress of aluminum. Hence the design is safe.

6 Mass reduction of quadrant assembly

Once we have achieved safe design of quadrant assembly next effort is being made to reduce mass of quadrant assembly by keeping stress level intact. The present mass of quadrant assembly is 1.824 kg and volume is 657840.450 mm³.

6.1 First experimental analysis

In first experiment material is taken out from both cutout of inner quadrant and also material is taken out in between the area of four bolt hole.

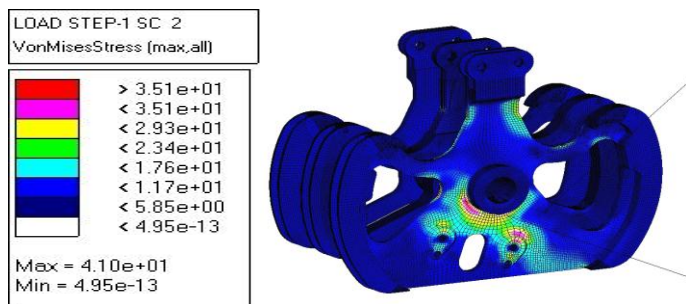

Fig -6.1: First experimental analysis of quadrant assembly.

This stress level is less than ultimate stress of aluminum. Hence material removal from both cutout of inner quadrant and also material removal in between the area of four bolt hole in the form of oval shaped hole is justified.

6.2 Second experimental analysis

In second experiment one cutout is made bigger by taking out material and divided into two parts. Now maximum stress level can be found out through analysis.

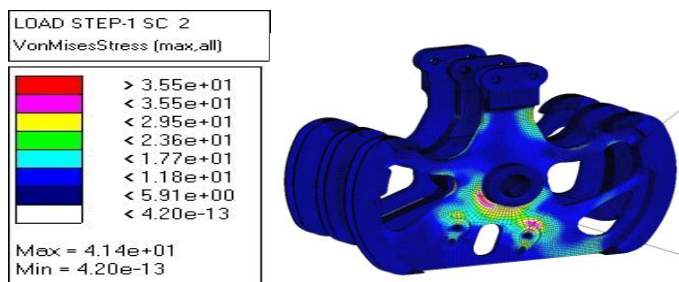

Fig -6.2: Second experimental analysis of quadrant assembly.

Thus stress level has not changed much and it is well below the ultimate stress of aluminum. Hence material removal from one cutout of inner quadrant is justified.

6.3 Third experimental analysis

In third experiment the cutout which was divided into two parts is made single by removing partition. Thus material is removed. Now the maximum stress level can be found out through analysis.

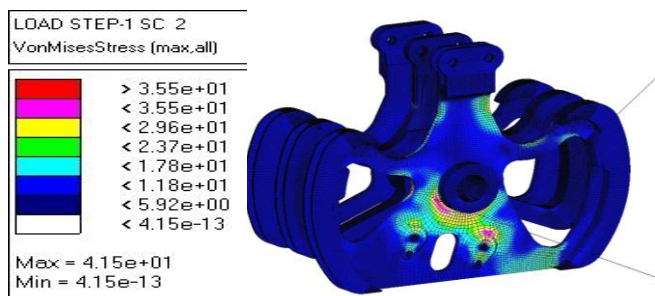

Fig -6.3: Third experimental analysis of quadrant assembly.

Thus stress level is not changed much and it is well below the ultimate stress of aluminum. Hence removal of partition material from one cutout of inner quadrant is justified.

6.4 Variation of stress, mass & volume of quadrant assembly.

The following table 6.1 shows the complete details of results of quadrant stress, mass, volume.

Table -6.1: Summary of variation of stress, mass and volume of quadrant throughout project work.

Number of Analysis / Experiment	Stress (kg/mm ²) (N/mm ²)		Mass (Kg)	% Mass Change	volume (mm ³)
	max	min			
Analysis-1	62.1	3.72 e-13	1.828	-----	652893.58
	609.201	36.49*e-13			
Analysis-2	70.2	9.19 e-09	1.834	0.328227	655056.4
	688.622	90.15*e-09			
Analysis-3	67.4	9.20 e-09	1.835	0.054525	655273.14
	661.194	90.25*e-09			
Analysis-4	40.6	4.74 e-13	1.842	0.381471	657840.45
	398.286	46.49*e-13			
Experiment-1	41	4.95 e-13	1.814	-1.35722	647923.74
	402.21	48.55* e-13			
Experiment-2	41.4	4.20 e-13	1.812	-0.110254	647101.44
	406.134	41.20* e-13			
Experiment-3	41.5	4.15 e-13	1.801	-0.607064	643369.85
	407.11	40.71* e-13			

The above table shows that the stresses in the quadrant are below the ultimate tensile strength of material. Hence the design of quadrant is safe. The percentage of mass is reduced is 2.23%.

3. CONCLUSIONS

The main objective of the project is to redesign the assembly and optimization for safe design.

The lever is redesigned and analysis is done the stresses are well below the ultimate stress of material therefore lever is safe. The mass optimization of lever is of 4.34%.

In case of quadrant assembly the stresses are well below the ultimate stress of material therefore the quadrant

assembly is safe. The mass optimization of quadrant assembly is of 2.23%.

The overall mass optimization = **6.57%**

Ultimately quality design of the product was achieved satisfying aviation requirements

REFERENCES

- [1] M. KOREN, "Computer Controls of Manufacturing Systems", Tata McGraw-Hill Edition 2005.
- [2] IBRAHIM ZEID, "CAD/CAM Theory & Practice", Tata McGraw Hill edition 1998.
- [3] TIRUPATHI R. CHANDRUPATLA., "Finite Elements in Engineering", third edition. Pearson education (Singapore) Pvt. Ltd., fourth Indian reprint 2005.