

# TCP/IP PROTOCOL BASED ADAPTIVE CRUISE CONTROL USING RASPBERRY PI

Devaraj.M<sup>1</sup>, PG Student, Dr. T. Kavitha<sup>2</sup>, Associate Professor

Nitin Awasthi<sup>3</sup>, VP Technical Manager, Chandrakanth V<sup>4</sup>, Embedded Design Engineer

<sup>1,2</sup> Dept. of Electronics and communication, BNM Institute of Technology, Bangalore, Karnataka, India

<sup>3,4</sup> VP Technical Manager and Embedded Design engineer, Apsis solutions, Bangalore, Karnataka, India

\*\*\*

**Abstract** - This paper gives the idea to develop Adaptive Cruise Control by using sensors and two Raspberry pi boards. The proposed system consists of two Raspberry pi, one is slave and other is master. One Raspberry pi act as slave and is responsible for detection various parameters like Distance between the vehicle, Wet weather monitoring, Road slope detection, Damaged road detection, Temperature monitoring, Location finding and Speed detection. Both the Raspberry pi, Slave is connected with master over TCP/IP channel. Here communication between the Master and Slave is based on the TCP/IP protocol i.e. sensed values from slave can send through TCP/IP channel via Ethernet cable (RJ45) to the master. Sensor values must be predefined as a threshold values are should be less, if these measured values are more than threshold values PWM pulses generated within the master. PWM signal will control the speed of the dc motor. Later LCD will display the values.

**Key Words:** TCP/IP protocol, Adaptive Cruise control, Raspberry pi

## 1. INTRODUCTION

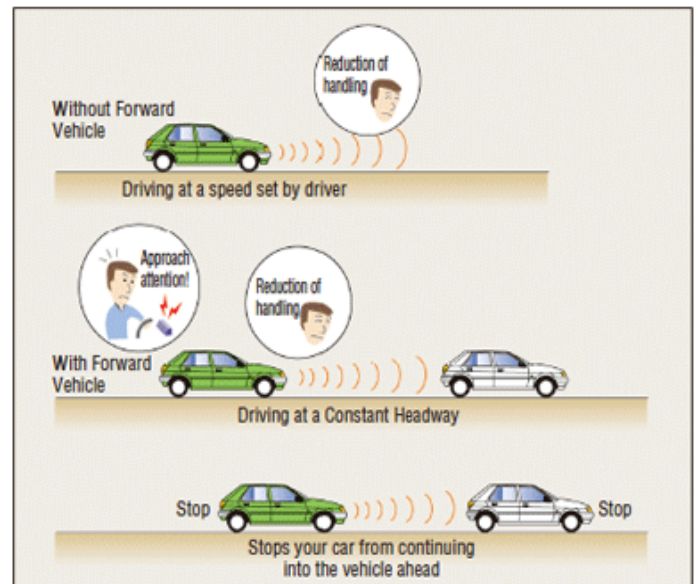
To reduce number of accidents in roads, to develop a system like Adaptive Cruise control. It consists of sensors to detect imminent crashes. When detection occurs, the system takes action to control automatically without driver inclusion.

In [1] "CAN Based Cruise Control in Traffic Situations", the objective of the intelligent vehicle framework is to decreasing traffic accidents and by expanding the flow. In proposed have two controllers, one acts as achieve movement to the forward vehicle and others one has controls speed of the vehicle. Here utilizing fundamental processor has ARM11 and lower controller has ARM Cortex M3. Slave can send the gathered data to the master by using CAN protocol is communication medium. The sensor values are fixed has threshold values must be less, if these values are above than threshold values then master will produces signals by using those signals can controlled speed of the motor.

In [2], "Intelligent vehicle system for driver assistance". This proposed framework comprises of two ARM controllers, sensors and CAN protocol. The one ARM controller acts as

slave which is responsible sensing values from the sensors. Other ARM controller acts as master which is controlling the motor. Here CAN protocol used for sending the values from the slave module to the master module [3].

In [4], "Adaptive cruise control", Adaptive cruise control has an some type of cruise control system which can controlled speed of the car automatically in order to achieve keep distance between the cars and range speed about at 20-25mph. Car having ACC system is detected the front vehicle, any object is detected, and system will slow down the speed and keep distance from the front vehicle set by driver. Once front car is cleared on the road the ACC system car will increasing the speed set by its driver and its shown fig 1.



**Fig 1:** Working principle of ACC

Some of things should be take into consideration in ACC as follows

- To be realized that the ACC framework can't work properly in some natural conditions like heavy condition are rain and fog, even when the street are smoothness high. Even in condition like dust or ice covering sensors.

- ACC can consume small energy to maintain keep separation from the front vehicle. Utilizing this innovation to give more concentration in traffic point, distance between the vehicle, and path changing in high ways.

In [5] "Collision Avoidance System in Heavy Traffic", this paper gives the working guidelines of ultrasonic sensor. This sensor comprising of 4 pins like trigger, echo, vcc and ground. Trigger pin is consistently transmits the signals, once object is detected that trigger signal is reflected back to the echo pin. The sensor will transmit the signal about 40 kHz which will travel in air is range about 1130 feet/sec. the pulse width can measure the twice the gap between the sensor and object. The calculation of distance between vehicle formulas as following

$$D=0.5 * C * (T1-T0).....1.1$$

Where, D= Distance to the object  
 C= Speed of sound  
 T0= Time at which sonic wave is transmitted  
 T1= Time at which sonic wave is received

## 2. PROPOSED METHODOLOGY

This paper gives the thought to create Adaptive cruise control by utilizing sensors and two Raspberry Pi boards. The proposed framework comprises two Raspberry pi, one acts as slave module and another one acts as master. This slave module can be used to recognition different parameters like Distance between vehicle by utilizing Ultrasonic sensor, Wet weather monitoring by utilizing Humidity sensor, Road slope detection by utilizing Accelerometer, Damaged road detection by utilizing Vibration sensor, Temperature monitoring by utilizing Temperature sensor, Location finding by utilizing GPS, Speed detection by utilizing RPM meter and master is responsible for controlling dc motor. Here both Raspberry pi, slave is associated with master through TCP/IP protocol. This TCP/IP protocol is used for exchange the information between salve module and master module. Salve sensor values must be defined as threshold values should be less, if those measured value are more than threshold values then master will produces PWM signals. By using PWM signals master will controlling speed of the dc motor and lastly values are displayed on LCD.

The proposed system consists of

a) **Obstacle Detection:** Ultrasonic sensor utilized for finding the obstacle in front of the vehicle. Sensor having four pins are Trigger, echo, vcc, and ground. Trigger is input which continuously transmits the signal, in case any obstacle find signal get reflated back to the echo pin. Slave will gather the information from the sensor to the master block through TCP/IP protocol. By utilizing PWM signal master will controlled dc motor.

b) **Wet Weather Monitoring:** It will checking the wetness of the vehicle close to the wheel by utilizing the humidity sensor and also furthermore gives the climate condition. In case hot air close tire which contain more dampness prompts to accidents by utilizing this sensor can be decreased.

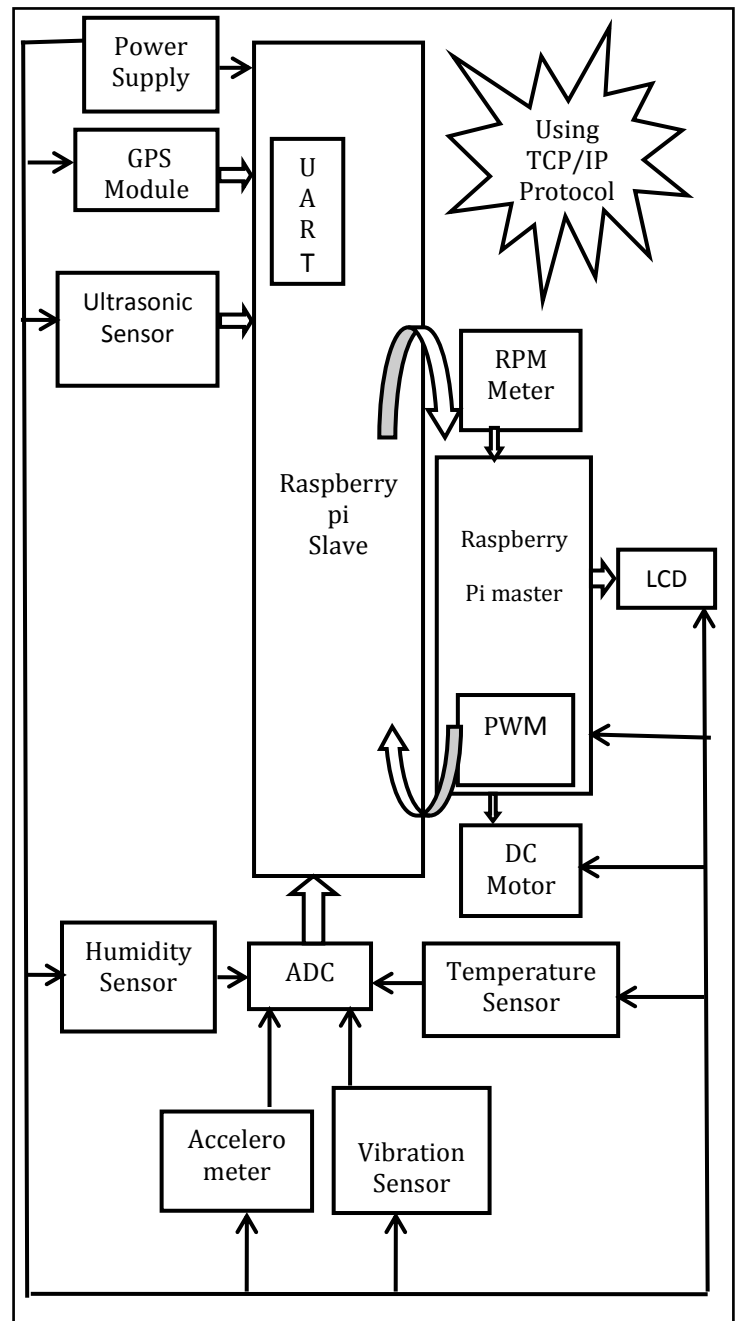


Fig 2: Block Diagram of Proposed System

c) **Temperature Monitoring:** Temperature sensor utilized for checking temperature close to the wheel of the vehicle and similar like wet weather monitoring.

d) **Road slope Detection:** This will recognize humps on the road and also detect the craving of the road by utilizing accelerometer. Additionally measure the acceleration of

vehicle. The sensor having three outputs are analog hence need to convert into digital by using ADC. Then converted data send to slave through master via TCP/IP protocol and lastly master will controlled dc motor by using PWM signals.

e) **Damaged road detection:** It will detect identify the harmed street by utilizing vibration sensor. The operation of the sensor like road slope detection.

f) **Location Finding:** It will finding the area of the vehicle position in longitude and latitude by Global positioning system (GPS).

h) **Speed Detection:** It will measures the quantity of pivot of vehicle wheel by utilizing revolution per minute (RPM).

### 3. IMPLEMENTATION

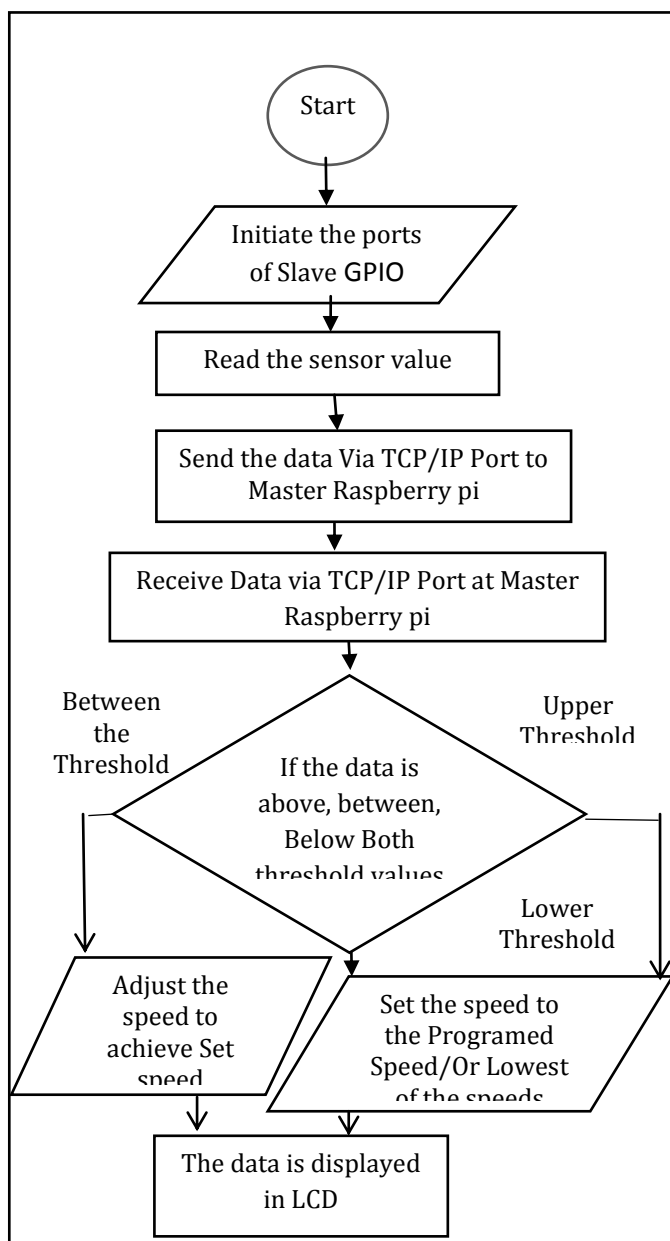


Fig 3: Flow chart of proposed system

In figure 3 consists of following steps

Step 1: Initialize all ports of Slave Raspberry pi GPIO pin to particular sensors like Ultrasonic, Temperature, Vibration, Humidity, accelerometer, RMP and GPS

Step 2: Sense values from the each sensor send to the slave module

Step3: In salve module, the sensed values then transfer to the master Raspberry pi via TCP/IP protocol

Step 4: Master will made decision according to the threshold values

Step 5: If in case sensed values are between the threshold values, adjust the speed set by its driver

Step 6: If in case sensed values are higher than or lower than the threshold values, set the speed according to the programed written.

Step7: At lastly the values should be displayed on LCD

#### Software used

In this venture we are using Raspbian working Linux. Raspbian is a free working OS in light of Debian progressed for Raspberry pi equipment.

Now a days Python is a most utilizing programing languages in world. Python has basic language in which can easily read out and express the syntax can also easy provides write different languages like java, c, c++ and furthermore gives composing code in small as well as large scale. There are some features like memory management, and also supports to objected oriented problems, multi programing, functional programing, and lastly procedural structures. Python is supporting all OS system which can run Varsity codes in the system. IDLE is a promote window to enter python commands and results are viewed in the figure 4.

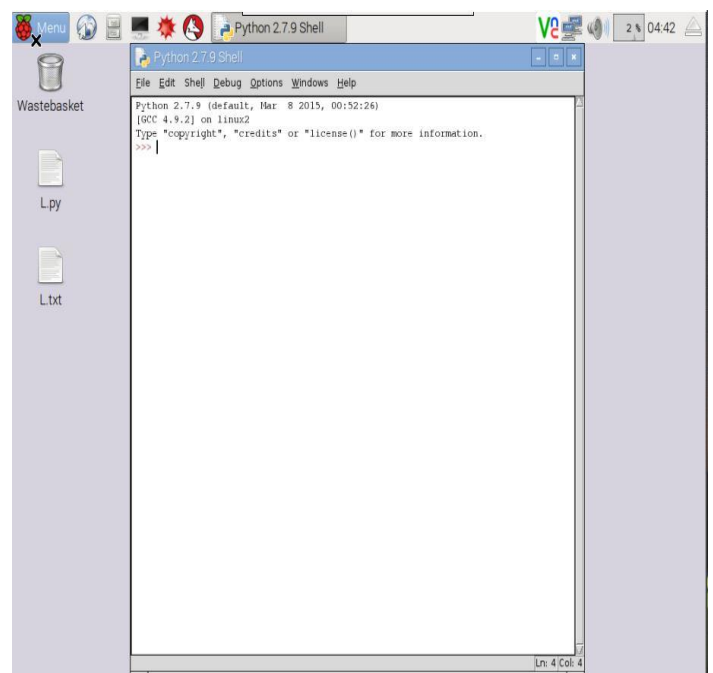
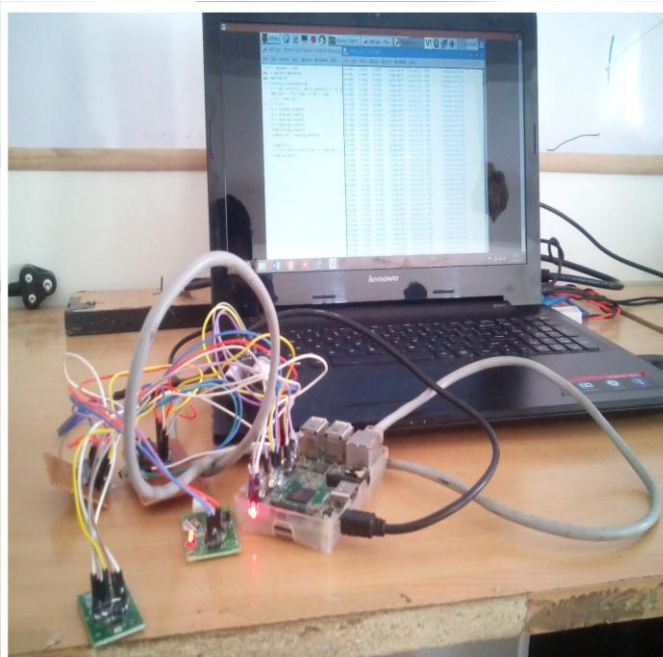


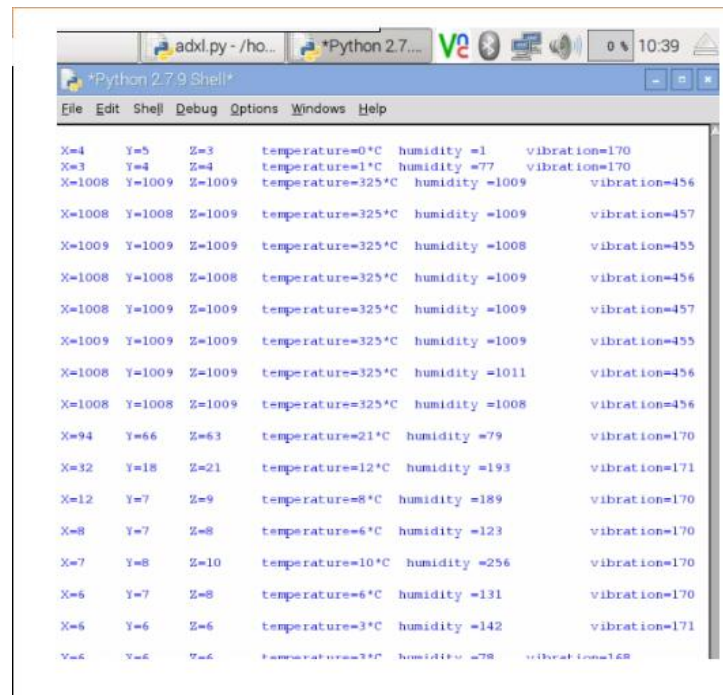
Fig 4: Python IDLE window



#### 4. OBTAINED RESULTS

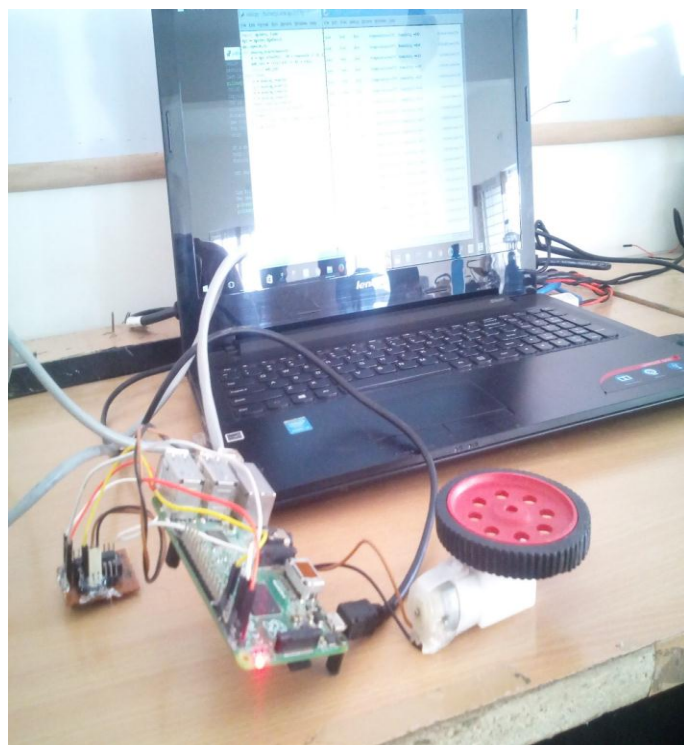


**Fig 5:** Interfacing sensors with Salve module  
In figure 5 shows the interfacing all sensors like Ultrasonic, Humidity, Vibration, Temperature, Accelerometer and GPS module with Raspberry pi salve module.

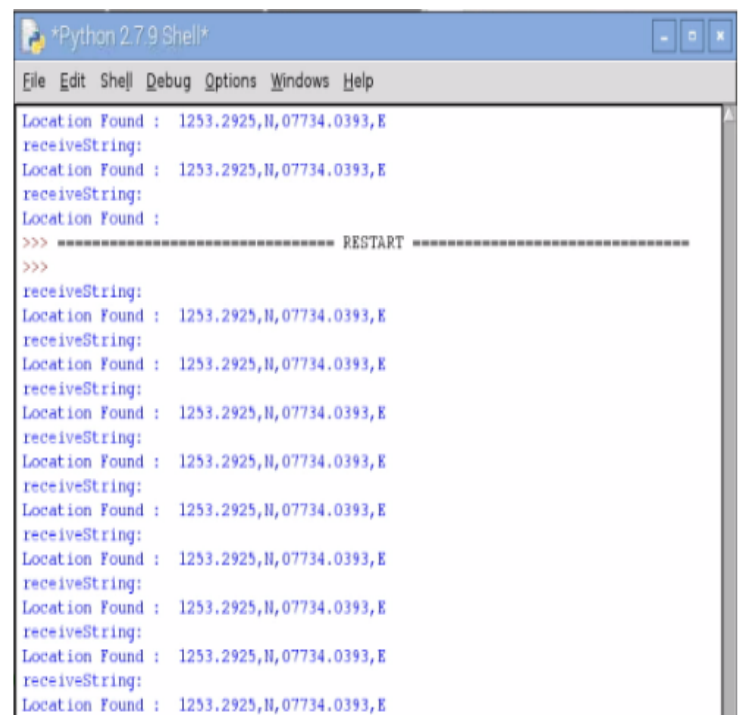


**Fig 7:** Sensor values

In figure 7 shows that all sensor values after interfacing. Sensors like Accelerometer, Temperature, Humidity, and Vibration values in python IDLE window.



**Fig 6:** Interfacing sensors with Master module  
In figure 6 represents the interfacing DC motor with Raspberry pi master module.



**Fig 8:** GPS values

In figure 8 shows that GPS values in Python IDLE window.

## 5. CONCLUSION

Driver action is affected by various factors that are related to the vehicle, the environment and through traverse of driving. Watching and perceiving the driver's movement to ensure road security has basic in light of the way that road mischance happen. In this way it is indispensable to catch driver exercises which will control road mischances because driver have lot of concentration setting one position, laziness, sleepiness, liquor and also poor weather conditions like fog , wetness of the road, some turning points.

The Proposed device was tested under various conditions of the sensors. And the results were observed to be satisfactory. The information index of driving excursions assembled amid this investigation was analyzed regarding general driving time and open door for ACC use, as measured by the quantity of occasions when the motor was going at various paces. In coming days, the framework can be improved by adding some more futures by decreasing the overload of the driver and diminish the cost of the usage.

## REFERENCES

- [1] M. Divya and G. Bhaskar Phani Ram, "Controller Area Network Based Cruise Control in Traffic Situations", International Journal of Current Engineering and Technology ©2015 INPRESSCO®, Vol.5, No.4 (Aug 2015)
- [2] Ashutosh U. Jadhav, N.M. Wagdarikar, "Intelligent vehicle system for driver assistance", International Journal of Advanced Research in Electrical, Electronics and Instrumentation Engineering, vol.4, Issue 7, July 2015
- [3] Ms. Divya K .S, Ms. K. A Drishya, Mr. Sakthiprasad .K .M , "Vehicle Speed Control System using CAN", IJSTE - International Journal of Science Technology & Engineering | Volume 1 | Issue 10 | April 2015
- [4] Prof. D. S. Vidhya, Miss Delicia Perlin Rebelo, Miss Cecilia Jane D'Silva, Mr. Linford William Fernandes, "Adaptive Cruise Control", IJRST International Journal for Innovative Research in Science & Technology| Volume 3 | Issue 01 | June 2016
- [5] Babu Varghese, Renju Thomas Jacob, Fajas Kamar and Rizwan Ali Saifudeen, "Collision Avoidance System in Heavy Traffic and Blind Spot Assist Using Ultrasonic Sensor", international journal of computer science and Engineering communication-IJCSEC. Volume 2, Issue.1, February 2014