

Home Security System and Door Access Control Based on Face Recognition

R. Manjunatha¹, Dr. R. Nagaraja²

¹M. Tech student, Computer Network Engineering, Dept. of ISE, Bangalore Institute of Technology, Bangalore, Karnataka, India

²Professor and PG Coordinator, Dept. of ISE, Bangalore Institute of Technology, Bangalore, Karnataka, India

Abstract - Smart security system has become indispensable in modern daily life. The proposed security system has been developed to prevent robbery in highly secure areas like home environment with lesser power consumption and more reliable standalone security device for both Intruder detection and for door security. The door access control is implemented by using face recognition technology, which grants access to only authorized people to enter that area. The face recognition and detection process is implemented by principal component analysis (PCA) approach and instead of using sensor devices intruder detection is achieved by performing image processing on captured video frames of data, and calculating the difference between the previously captured frame with the running frames in terms of pixels in the captured frames. This is the stand alone security device has been developed by using Raspberry Pi electronic development board and operated on Battery power supply, wireless internet connectivity by using USB modem. Auto Police e-Complaint registration has been achieved by sending security breach alert mails to the nearby police station e-mail id. This proposed is more effective, reliable, and this system consumes very less data and power compared to the other existing systems.

Key Words: Home security system, Door lock access, Face Recognition, Security breach alerts, Intruder detection.

1. INTRODUCTION

An efficient and accurate home security and access control to the doors system which is based on face recognition is very important for wide range of security application. Security is an important aspect or feature in the smart home applications [5]. Most of the countries are gradually adopting smart door security system. The most important major part of any door security systems are identifying accurately the persons who enter through the door. Face recognition is probably the most natural way to perform authentication between human beings. Additionally, it is the most popular biometric authentication trait, after fingerprint technology. Most of the security system was implementing a principle component analysis (PCA) algorithm for face recognition on hardware platform for its dimensionality reduction and simplicity. Wireless technologies for example and ZigBee, radio frequency identification (RFID) and etc are used in access control systems. This proposed system also act as home security system for both Intruder detection and provide security for

door access control by using facial recognition for home environment.

Human body is identified as an intruder within a home environment achieved by capturing live video from web camera and processing will be done on captured video frames to identify the motion detection of the intruder. The web camera to capture the series of images as soon as the intruder motion is detected in certain area of the home premises and also it is having sending automatic e-Mail alerts along with captured images and other contact details to the nearby police station control room e-Mail id about the intruder detection to take further immediate necessary actions.

The advantage of this system is for accessing the door is that face detection and recognition is performed by using face detection technique and the entire face recognition is completed by pressing single and tiny push button switch. Face recognition includes feature extraction from the facial image, recognition or classification and feature reduction. PCA is an effective feature extraction method used based on face as a global feature. It effectively reduces the dimension of captured images and at the same time holds the primary information. In this project, face recognition system is implemented based on standard PCA (Principle component analysis) algorithm. Classification or Recognition is done by the measure method such as Euclidean distance technique, which is used to classify the feature of images stored in the database and captured test images [2].

2. LITERATURE SURVEY

Hteik Htar Lwin and et al. Have proposed a door lock access system which comprised mainly of three subsystems: namely face detection, face recognition and automatic door access control. Face recognition is implemented by using the Principal Component Analysis (PCA). The door will open automatically for the known person due to the command of the microcontroller. On the other hand, alarm will ring for the unknown person. Drawback of this system is input images are taken through a web camera continuously until the 'stop camera' button is pressed [1]. Someone is required at the location to check unauthorized person's images or status of the system and take further action. Personal computer (PC) is connected with the microcontroller, The whole system will not work if PC is crashed or Non-Function.

Sadeque Reza Khan and et al. Have proposed a system contains sensors to detect obstacle, touch, heat, smoke, sound. The whole system is controlled by a PIC microcontroller 16F76. It collects information from the sensors, makes a decision and sends SMS to a corresponding number by using a GSM modem. If it finds any interruption in its sensors like if the IR is interrupted then PIC will send a SMS to the home owner and another SMS to the Police Station. In the same way for fire interruption a SMS will be sent to the fire brigade and another to the home owner [2]. In this system require extra hardware components like Sensors, GSM Modem. Alerts are sent through only SMS.

B. Udaya Kumar and et al. presents the implementation of a low cost wireless home security system using ZigBee protocol and remote access through internet [3]. A ZigBee based star network with two nodes had been established employing Xbee radio, ARM7, PIC, and MBED microcontroller. The detection of the intruder motion, gas leakage detection and visual surveillance of the home were provided with the help of Passive Infrared Sensor (PIR), Gas sensor (GH-312) and Camera (LS_Y201). Problem is here multiple micro controllers are used, usage of ZigBee based network to communicate with the base station is limited to 100-150 meters long distance only. Base station is dependent on only Ethernet for internet connectivity.

J. Shankar Kartik and et al. Have proposed two systems are proposed, one is based on GSM technology and other uses web camera to detect the intruder. The first security system uses a web camera, installed in house premises, which is operated by software installed on the PC and it uses Internet for communication. The camera detects motion of any intruder in front of the camera dimensions or camera range. The software communicates to the intended user via Internet network and at the same time it gives sound alert. The second security system is SMS based and uses GSM technology to send the SMS to the owner [9].

Mae .Y and et al. presented the system; it monitors everything by moving cameras. The system can increase the efficiency of monitoring and can eliminate the blind spots of fixed cameras. In this system, a mobile manipulator is developed which is equipped with cameras at the arm end for purpose of monitoring [6].

Jayashri Bangali and et al. Have proposed an system which is aimed at the security of Home against Intruders and Fire. The proposed system is controlled by an Atmega644p microcontroller. It collects information from the sensors, makes a decision and sends SMS to a corresponding number by using a GSM modem. If it finds any interruption in its sensors (for example IR sensor) then microcontroller will send a SMS to the home owner. In the same way if the temperature is increased above certain point or gas sensor sensors is ON, a SMS will be sent to the home owner 'Fire at home' giving the indication of fire[4]. This system operated by software in PC to detect the intruder that is it is not stand

alone system, dependent on the PC. Security alerts are sent by extra GSM Modem not from the internet.

3. SYSTEM ARCHITECTURE

The Architecture of the proposed system are the design diagram which depicts the scope of the project with the whole system design. In architecture diagram it highlights the modules with its various functionality as process. It aims to convey the internal design of the proposed system the following Fig -1 shows the entire architecture of the proposed system.

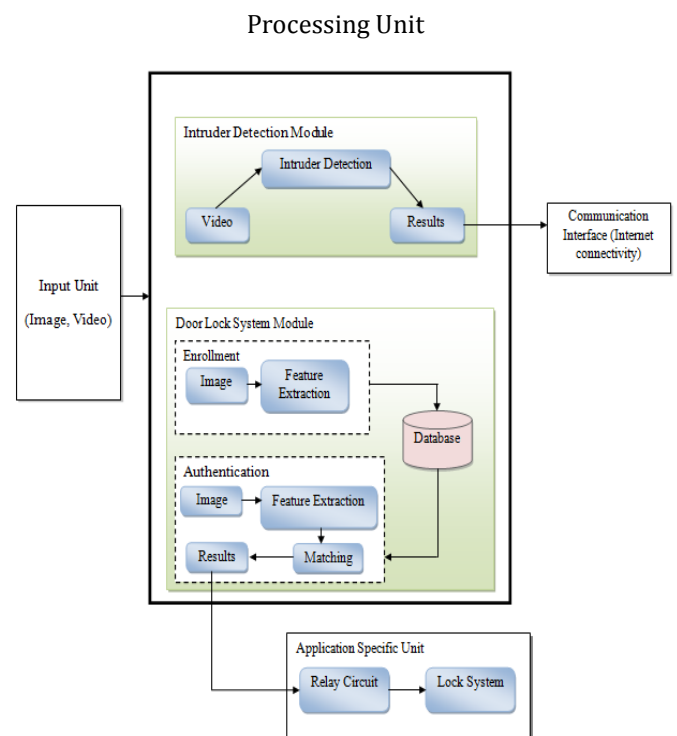

Fig -1: System Architecture

3.1 Input Unit

In input unit the Facial images for Face Recognition and Video frames for intruder detection are captured from the two different camera input devices respectively i.e. from Raspberry Pi Camera and Web camera.

3.2 Processing Unit

The data which is collected from Input unit that is captured Image and Video frames input is fed into the processing unit in which the processing or calculations are performed on the proposed Intruder detection and door lock system module, Here the processing unit is nothing but a Raspberry Pi board [8], along with code scripts of the implemented modules.

3.3 Communication Interface

Communication interfaces which include wireless internet connectivity devices are associated with the Intruder detection module used to send alert messages in the form of e-mail and SMS by using Internet connectivity.

3.4 Application Specific Unit

The Application specific unit which consists of Door lock circuitry, it is associated with Door lock system module and it starts functioning according to results of the module to perform door lock open/close operation based on Face Recognition.

4. IMPLEMENTATION

There are two parts in this section. The first is the implementation of Door lock access by using Face Recognition and the second is the implementation of Intruder detection along with auto alert sending.

4.1 Implementation of Door Lock Access by using Face Recognition

This project work proposes an idea of for face reorganization concept for accessing the door lock system and it implemented with the help of OpenCV [7] which is a popular computer vision library. Face recognition is an important application of image processing owing to its use in many fields. An effective face recognition system based on OpenCV is developed in the project. Face recognition has been a best choice after problem of biometrics and it has a various type of applications in our present life. An efficient face recognition system can be of great help in forensic sciences, identification for law enforcement, authentication for banking and security system, and giving preferential access to authorized users i.e. access control for secured areas etc.

A real time door lock access system by face recognition system based on PCA is presented in the project. The technique used here involves generating the 'Eigen faces' then projecting training data into face space and evaluation of a projected test element by projecting it into face space and comparing to training data. The face recognition systems presented here can extract the features of face and compare this with the existing facial images of database. The faces considered here for comparison are still faces.

4.2 Implementation of Intruder Detection along with Auto Alert Sending.

The proposed home security system (i.e. Intruder detection Module) builds up on the frame subtraction approach. The main purpose of this approach is to build a model of the static scene (i.e. without moving objects) called background, and then compare every subsequent frame of the sequence to this background frame in order to identify the regions of motion, called foreground (the moving

objects). A procedural view of how this intruder detection works is shown in Fig -2.

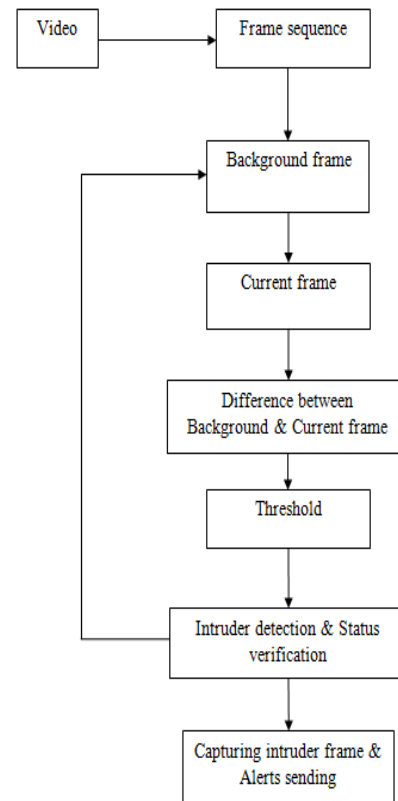

Fig -2: Procedural View of Intruder Detection and Alerts Sending

The background frame or first frame of our video stream is largely static and unchanging over consecutive frames of a video. Therefore, we can use the above mentioned approach to model the background frame, and we handle it for variations in sub sequential frames. If there is a change in sub sequential frames, we can detect it and this change usually considered as motion detection on video.

5. HARDWARE CONNECTION SETUP

The most important part of the project is the hardware implementation in accurate manner. The electronics components of the project are very easily understood and it includes connection of various hardware devices to the Raspberry Pi development board via GPIO pins and various other available ports without need of soldering the wires for connection. The following Wiring diagram Fig -3, shows how to connect and integration of the required hardware components of the proposed system like Electronic lock, Push button switch, Relay, Raspberry Pi board, Raspberry Pi camera, Web Camera, Wi-Fi Receiver Adapter, Power bank source with Internet data card dongle.

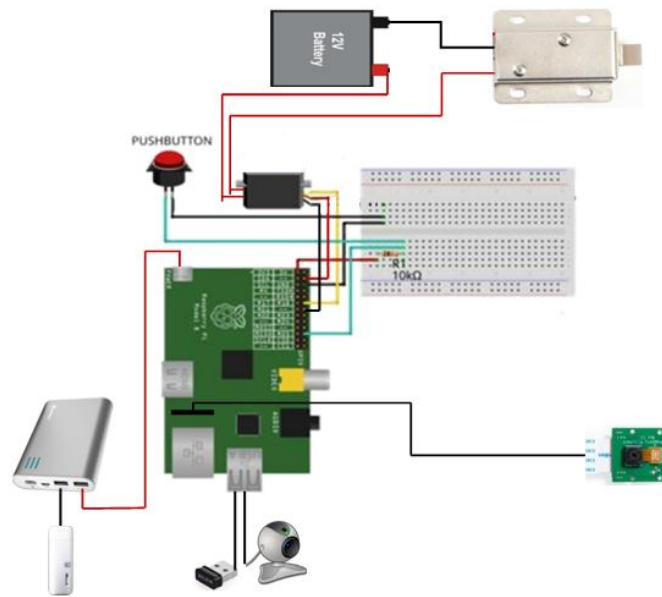

Fig -3: Hardware connection setup

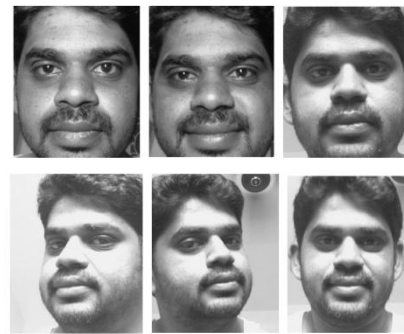

Fig -5: Stored positive images

Consider the following Fig -6, after the complete configuration and deployment of the proposed security system and when the device is powered up both the Module 1 and Module 2 are started executing on startup automatically without manual interaction. We can see the two windows has opened automatically one for executing scripts and another one is "Security Feed" which is a streaming view via the Web camera for intruder detection module.

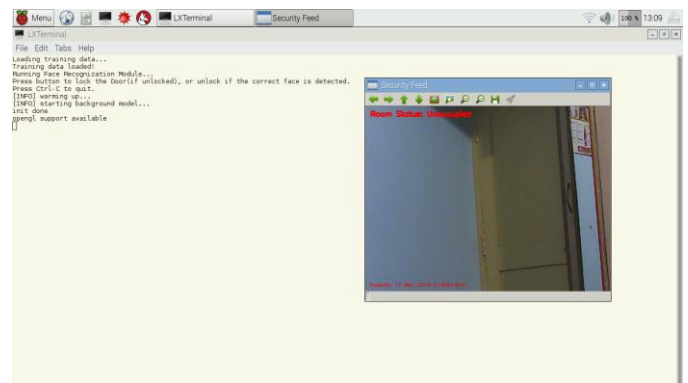

Fig -6: Running the device on startup

6. RESULTS AND DISCUSSIONS

Consider following Fig -4, To capture the training images to store in the database the following commands need to run on the terminal as shown in the below figure if the face is detected it captures and stored in folder.

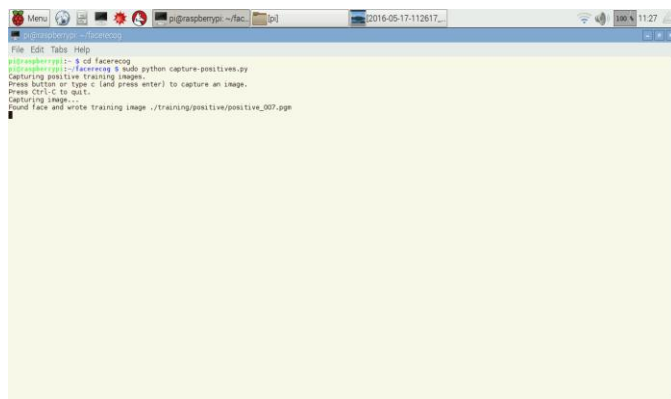

Fig -4: Storing captured images

The captured images are stored in folder; captured images are look like as following images in grayscale format as shown in Fig -5.

Consider the following Fig -7, As soon as the authenticated person is identified by pointing his face towards the door camera and presses the push button switch to verify authenticity of the facial image, the system has predicted as POSITIVE face with required range of threshold value which is enough for the authentication of the persons face. And door lock has been unlocked successfully. When the push button switch is pressed again door has locked again. It has showing error message also when face has not detected properly.

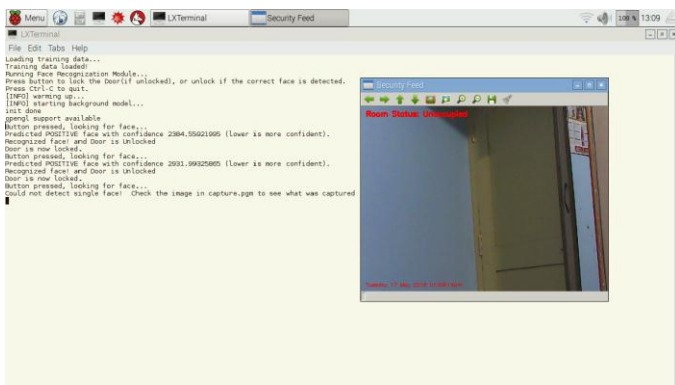

Fig -7: Unlocking and locking the door lock

In the following Fig -8, the intruder detection module has been activated started capturing continuous live video frames from the web camera as shown in Fig. we can see in the security feed window separately. Whenever an intruder has detected via web camera it has started capturing intruder images, attaching these images to the mail and sending it to the concern police department e-Mail Id, It is also sending SMS alert as we can see in the screenshot.

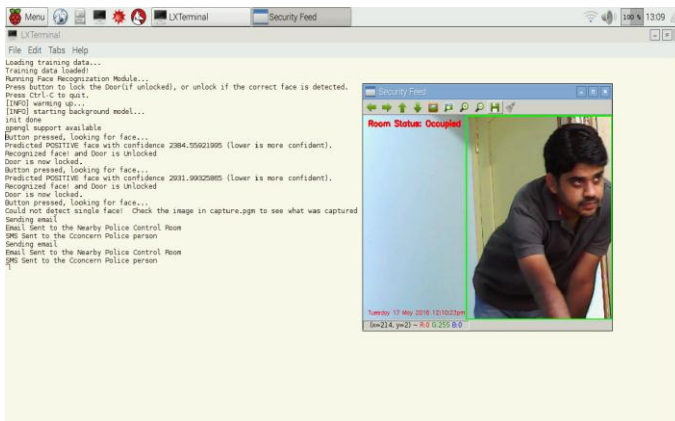

Fig -8: Sending security breach alerts

In the following Fig -9 it is showing that the reception of e-Mail alert into the inbox of the nearby police department mail account from the security system along with the intruder detection details like attached image and contact details to take the immediate actions from them.

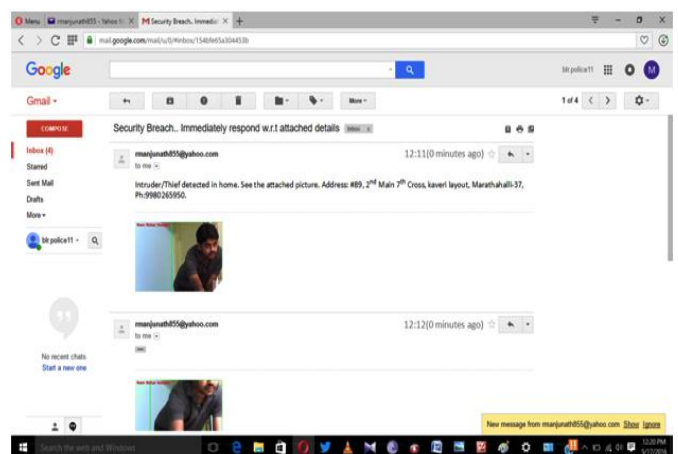

Fig -9: Mail inbox screenshot

The following Fig -10 shows the screenshot of the reception of the SMS security alerts which has sent from the security device via SMS sending API when an intruder has been detected.

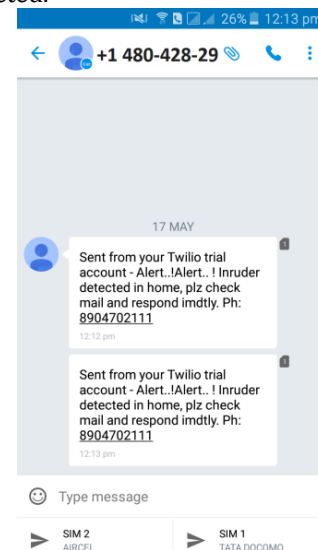

Fig -10: SMS Alerts

7. CONCLUSION AND FUTURE WORK

In this proposed system door access system by using face recognition and along with the Intruder detection system has been presented. This system has been tested successfully with home door lock access control based on face recognition method by verifying enrolled facial images. The police department control room of a nearby place and concern persons will be informed successfully about the intruder detection via e-Mail and SMS alert generations along with details attached.

The proposed system is completely standalone and wireless to form a reliable, robust, easily operable, and low price security system. The internet communication has been achieved by connecting through USB cellular data card. The battery power source has been provided to make this whole

system as standalone security device successfully. I conclude that various operations are successfully tested and results are documented.

This proposed system can be enhanced by using the infrared image scanner camera to find concealed weapon detection under the clothes of the human body. We can also use this security system by making required modification to the system in an area like banking sector to provide more security to the lockers, based on their facial authentication and keep track of account holders record of information when and who is accessed the lockers. In this way we can enhance the proposed system effectively by making some modifications according to requirements.

REFERENCES

- [1] Hteik Htar Lwin, Aung Soe Khaing, Hla Myo Tun, "Automatic Door Access System Using Face Recognition", International Journal of Scientific & Technology Research Volume 4, Issue 06, June 2015.
- [2] Sadeque Reza Khan, Ahmed Al Mansur, Alvir Kabir, Shahid Jaman, Nahian Chowdhury, "Design and Implementation of Low Cost Home Security System using GSM Network", International Journal of Scientific & Engineering Research, Volume 3, Issue 3, March 2012.
- [3] B. Udaya Kumar, D. S. Murty, Ch. R. Phani Kumar, "Implementation of Low Cost Ethernet Based Home Security Using Wireless Sensor Network", Journal published at Algorithms Research, March 2013.
- [4] Jayashri Bangali, Arvind Shaligram, "Design and Implementation of Security Systems for Smart Home based on GSM technology", International Journal of Smart Home, Vol.7, No.6, August 2013.
- [5] V. Karri and J. S. Daniel Lim, "Method and Device to Communicate via SMS After a Security Intrusion", 1st International Conference on Sensing Technology, Palmerston North, New Zealand, (2005) November 21-23.
- [6] Mae .Y, Sasao .N, INNoue .K, Arai .T, "Person Detection by Mobile Manipulator for Monitoring", SICE 2003 Annual Conference, pages-2801-2806.
- [7] <http://downloads.sourceforge.net/project/opencvlibrary/opencv-2.4.zip>
- [8] <https://www.raspberrypi.org/products/model-b>
- [9] J. Shankar Kartik, K. Ram Kumar and V.S. Srimadhavan, "SMS Alert and Embedded Network Video Monitoring Terminal", International Journal of Security, Privacy and Trust Management (IJSPTM), Volume 2, October 2013.