

Optical Fibres by using Digital Communication without Direct Current to Detect CFD

MD.Sattar¹, A.H.SHARIEF²

¹Student, Department of ECE, GISTcollege, Andhra Pradesh, INDIA

²Associate Professor, Department of ECE, GISTcollege, Andhra Pradesh, INDIA

Abstract - This paper describes a cable fault detection system (CFD) in Optical Fibres by using Digital communication technology without Direct Current. A fault detection system is provided for detecting and locating faulty connections in a Optical cable system. First and second signals are generated at the head end transmitter. The first signal is a continuous wave signal. The second signal is a pulse modulated sine wave signal. A fault is indicated by the reception of a beat frequency signal between the first and second signals generated at the location of the faulty connection and returned to the head end. which can be powered from either fault currents or the normal flow of power through the cable, and is able to transmit digital fault current data using optical fibre. The paper describes the architecture developed to realize extremely low-power consumption together with other features of the device

Key Words: Current differential relay, No DC power supply, Cable Fault Detection (CFD), Optic digital communication Synchronization

1.INTRODUCTION

Optical fiber has a number of advantages over the copper wire used to make connections electrically. For example, optical fiber, being made of glass or plastic, is immune to electromagnetic interference which is caused by thunderstorms. Also, because light has a much higher frequency than any radio signal we can generate, fiber has a wider bandwidth and can therefore carry more information at one time. Most telephone company long-distance lines are now of optical fiber. Transmission on optical fiber wire requires repeaters at distance intervals. The glass fiber requires more protection within an outer cable than copper. For these reasons and because the installation of any new wiring is labor-intensive, few communities yet have optical fiber wires or cables from the phone company's branch office to local customers.

1.1Transmitters

Fiber optic transmitters are devices that include an LED or laser source, and signal conditioning electronics, to inject a

signal into fiber. The modulated light may be turned on or off, or may be linearly varied in intensity between two predetermined levels. Light Emitting Diodes (LEDs) have relatively large emitting areas and as a result are not as good light sources as laser diodes. However, they are widely used for short to moderate transmission distances because they are much more economical. Laser diodes can couple many times more power to optical fiber than LEDs. They are primarily used for applications that require the transmission of signals over long distances.

Important performance specifications to consider when searching for fiber optic transmitters include data rate, transmitter rise time, wavelength, spectral width, and maximum optical output power. Data rate is the number of data bits transmitted in bits per second. Data rate is a way of expressing the speed of the transceiver. In the approximation of a step function, the transmitter rise time is the time required for a signal to change from a specified 10% to 90% of full power. Rise time is a way of expressing the speed of the transmitter. Wavelength refers to the output wavelength of the transceiver. The spectral width refers to the spectral width of the output signal.

1.2 Receivers

Fiber optic receivers are instruments that convert light into electrical signals. They contain a photodiode semiconductor, signal conditioning circuitry, and an amplifier. Fiber optic receivers use three types of photodiodes: positive-negative (PN) junctions, positive-intrinsic-negative (PIN) photodiodes, and avalanche photodiodes (APD). PIN photodiodes have a large, neutrally-doped region between the p-doped and n-doped regions. APDs are PIN photodiodes that operate with high reverse-bias voltages. In short wavelength fiber optic receivers (400 nm to 1100 nm), the photodiode is made of silicon (Si). In long wavelength systems (900 nm to 1700 nm), the photodiode is made of indium gallium arsenide (InGaAs). With low-impedance amplifiers, bandwidth and receiver noise decrease with resistance. With trans-impedance amplifiers, the bandwidth of the receiver is affected by the gain of the amplifier.

Typically, fiber optic receivers include a removable adaptor for connections to other devices. Data outputs include transistor-transistor logic (TTL), emitter-coupled logic (ECL), video, radio frequency (RF), and complementary metal oxide semiconductor (CMOS) signals. Also, it uses many types of connectors.

2. Cable Fault Detection System

2.1 System configuration of conventional devices

Since it is difficult to provide DC power supply facilities at cable head-ends, conventional CFD systems have been applied using devices that do not require these facilities with analog relays or optical current transformers (OCT). A typical example of the system configuration of a CFD device employing an analog Pilot Wire Relay (PWR) is shown in Fig. 1. Even though there are no DC power supply facilities at the cable head-ends, by means of configuring a differential circuit using a pilot wire cable, faults within the OF cable can be detected, as illustrated in Fig.1. An example showing the system configuration of a CFD device employing an OCT The master device at the sending terminal is equipped with DC power supply facilities. A fault within the cable section can be detected by configuring a differential circuit using optical fibre.

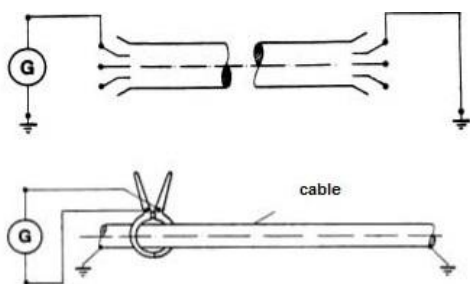

Fig-1: System configuration of CFD employing an analog PWR

2.2 System configuration of the devices developed

As illustrated in Fig.-2, the CFD system developed consists of a master device installed at the sending terminal which is powered from the local DC power supply facilities, and a slave device located at the cable head-ends which does not have DC power supply facilities. The slave generates its DC power from the normal power that flows in the power system or from the fault current generated by a fault on the power system. Following A/D (Analog/Digital) conversion of the power system electrical quantity measured the slave then transmits the data to the master using optical fibre. The master identifies the faulted section by means of a current differential calculation using the power system data derived

from the measured electrical quantity at the cable head-end, received from the slave, and the data determined from the measured electrical quantity at the local end.

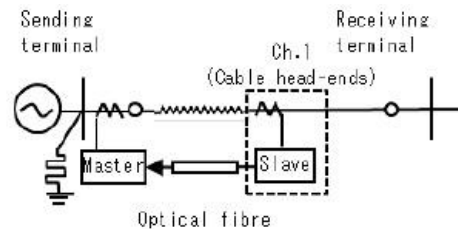

Fig-2: System configuration of the devices developed

3 Architecture without DC Power Supply

3.1 Slave architecture and principle of operation

The slave developed is intended for installation at locations where there is no DC power supply available. As illustrated in Fig. 3, for a current generated in the power system the secondary current of the input transformer is rectified using a power extraction circuit within the DC power generation the output current is used to charge a condenser. From the above, it is possible for the slave to extract DC power such that it is able to operate using current derived from the power system. The limiter circuit is used to protect the slave from over voltage, and to limit the burden imposed on the primary side of the input transformer in the provision of the DC power supply.

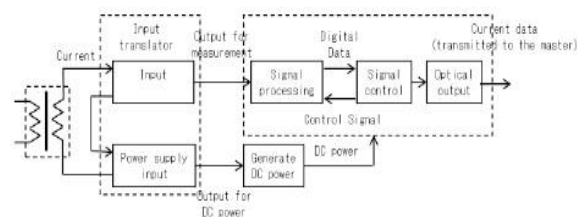

Fig-3: Functional block diagram of remote terminal

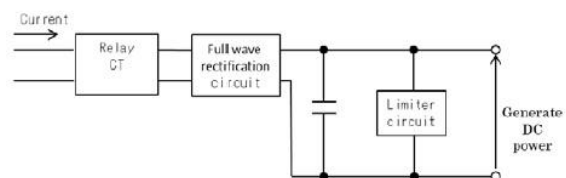

Fig-4: Power extraction circuit derived from CT secondary current.

The DC power supply is used to energize signal processing, signal control and optical output circuits which perform the A/D conversion of the signal output from the signal input translator module. As shown in figure 4, The measured

electrical quantity is sent to the master in the form of optical digital data.

3.2 Low-power concept of slave

3.2.1 Reduced component count

The main function of the slave can be Powered using current generated from the electrical power system. The A/D conversion of the electrical quantity data measured when powered. Conversion of electrical digital data to optical digital data, and transmit to master. Reduced power consumption within the slave can be achieved by reducing all circuitry to the absolute minimum necessary to perform these functions, and by minimizing the number of components.

3.2.2 Low power consumption of the main circuit

We used low-power devices in each part of the circuit. In the circuit constituting the slave, the power consumption of the optical output part and the signal control part is high. In order to reduce power consumption the signal control circuit does not use a CPU; instead a Programmable Logic Device (PLD) was adopted. Rather than an active filter, a passive filter was used for input filtering in the signal processing circuit.

3.2.3 Low power consumption of the optical output

Traditional current differential relays adopt the CMI (Code Mark Inversion) code for optical transmission format. This is repeated at a transmission speed of 54Kbps with an electrical angle of typically 30 degrees between samples. The devices developed adopt a RZ (Return to Zero) form of digital data transmission, and the average transmission rate employed is 1Mbps. Thus, it was possible to reduce the power consumption by shortening the LD (Laser Diode) emission time as shown in Fig-5. The LD emission time is approximately 7% of that for CMI data transmission. Hence, it is possible to reduce the average current consumption of the LD.

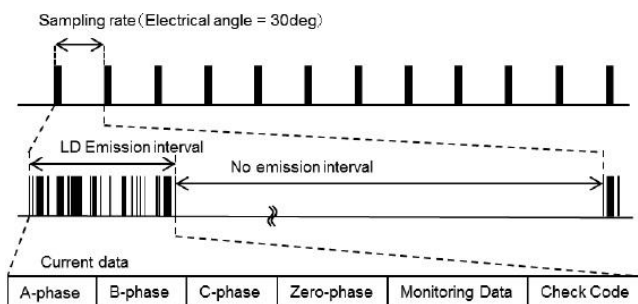

Fig-5: Transmission format

4. Sampling Synchronisation Mechanism

In order to perform a differential operation on the current data obtained by performing the A/D conversion in a predetermined cycle, the sampling timing of the Slave device and Master device must be the same. Current differential relays used for the protection of transmission lines normally implement synchronous control of the sampling timing by transmitting synchronization control data between the slave device and the master device. However, since the slave device used in the CFD system does not include a CPU, it is unable to perform sampling synchronization control in a conventional manner. Since this system is one in which the master device and slave device starts asynchronously, it is necessary to establish the synchronization of the sampling timing immediately after start-up when operating only with fault current without power flow. For this reason, the system that has been developed determines the difference in the sampling timing between the master and slave by measuring the sampling timing of the slave at the master side. It then generates synchronized electrical quantity data by performing an interpolation calculation on the electrical quantity data received from the slave. In Fig. 6 and Fig. 7 we have shown the method used for calculating the difference between the sampling timing of the slave and the master. The value of it is calculated by subtracting the compensation value, which is fixed, from the time at which the electrical quantity data from the slave station arrives at the master station. It includes the transmission delay time and processing time for data transmission at the slave.

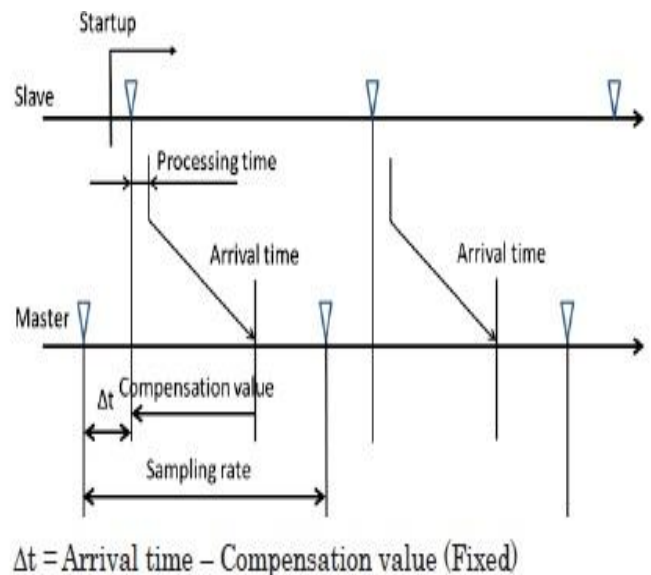

Fig-6: Synchronization method

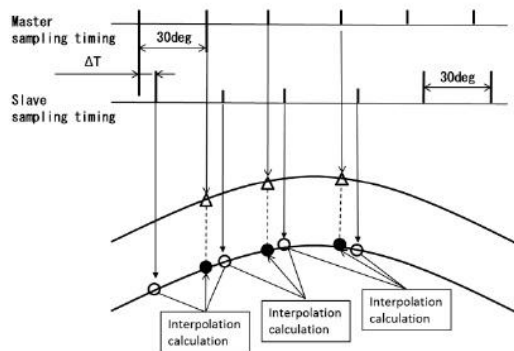

Fig-7: Interpolation method

5. Field trial equipment

We prepared equipment for a field trial in order to verify the performance of the CFD protection in the environment in which it will be applied. The master device was equipped with 87G and 87S (current differential elements), 27S (under voltage element) and 64V (earth fault over voltage element). Both master and slave devices were equipped with a 51S (over current element) to confirm the level of power flow when monitoring the start-up of the slave station. The block diagram of the fault detection logic implemented in the verification equipment We implemented the CFD system function and a digital relay function for data recording in the slave device. It includes 64V and 27S elements to enable us to analyze the start-up behaviour of the relay element. as shown in the fig-8. The analyzer function in the recording unit at the slave and the master has been provided with a recording function to save the data at regular intervals and also trigger on relay operation. These two types of data were evaluated. The field trial was undertaken at a 66kV substation owned by Kyushu Electric Power during the period extending from March 2012 to November 2012.

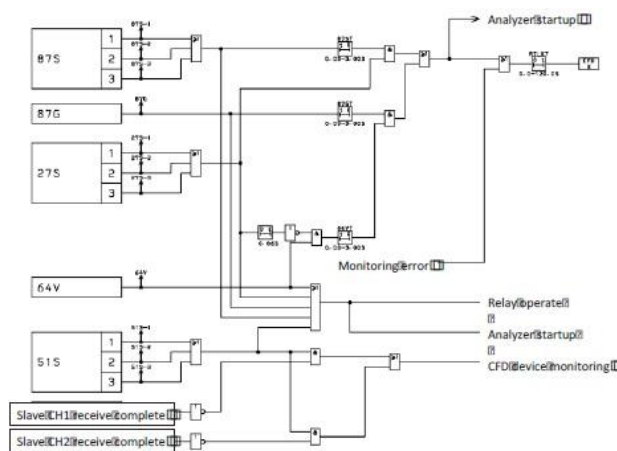

Fig-8. Schematic diagram of the CFD system developed

6. System incident data analysis results

System incident data was obtained for 11 cases during the evaluation, all of which were external faults. In Table 1 we have shown the relay operation data for the 11 cases together with the dates on which it was recorded. The 51S element always operates when power is flowing, and resets if the current reduces below its setting value during a system incident. As all 11 cases were external faults, the 87S and 87G elements did not operate. In all 11 incidents, the slave was operational by means of power flow prior to the incident

Table-1: Fault record stored in master and slave

No.	Date	Master				Slave		
		87S	87G	27S	64V	51S	27S	64V
1	14 Jul	-	-	Op.	Op.	Res.	-	Op.
2	30 Jul	-	-	Op.	-	-	-	-
3	8 Aug	-	-	Op.	-	-	-	-
4	11 Aug	-	-	-	Op.	-	-	Op.
5	12 Aug	-	-	Op.	-	-	-	-
6	14 Aug	-	-	Op.	-	Res.	Op.	-
7	17 Aug	-	-	Op.	-	Res.	-	-
8	22 Aug	-	-	-	Op.	-	-	Op.
9	5 Sep	-	-	Op.	-	-	-	-
10	22 Oct	-	-	-	Op.	-	-	Op.
11	13 Nov	-	-	Op.	-	-	-	-

- : No operation
Op. : Operation
Res. : Reset

In the following explanation we discuss the data retrieved from the slave side for the external fault that . we have shown the zero-phase current received from the slave and the master zero-phase current used by the 87G element in the differential calculation. Zero-phase current is already flowing as a through current prior to the fault incident in this case. Excessive zero-phase current is flowing for the ground fault, but does not show any abnormal operation for the current at the slave. In addition, it is operating correctly by extracting DC power from the fault current in the actual electric power system. The phase is reversed correctly in comparing the slave side and the master side, the sampling synchronization control by the interpolation calculation is therefore correct in this case. we have shown the waveform of the restraint current and the differential zero-current that is calculated in the 87G element. We can see that only restraint current is being generated and hence the sampling synchronization control process is working correctly. From the above results, we were able to confirm that the verification devices are able to perform the current differential calculation correctly and that the slave device is able to extract power from the actual fault current.

7. CONCLUSIONS

We have developed the aforementioned CFD system and have been able to confirm the validity of its performance through detailed evaluations which include the characterization of the initialization time of the slaves and the protection relay elements. We confirmed the anticipated behavior of the prototype system by means of a field trial. In the future, we will proceed with a detailed specification study based upon the findings of the field trial, and an application with a branch load end.

REFERENCES

- [1] Kiyonori Motoyama, Masao Takahashi, Hideaki Sugiura and Kenshi Iihoshi : "Cable Fault Detection System employing Fiber Optic Digital Communication and Remote Terminal without DC power supply", Technical Meeting on Power Protective Relay, IEE Japan, PPR-12-028, (2012)
- [2] Takahiro Mori, Satoshi Shinsho and Takeshi Mawatari : "Field evaluation of Cable Fault Detection System and Remote Terminal without DC power supply", Technical Meeting on Power Protective Relay, IEE Japan, PPR-13-003, (2013)