

Analysis & Design improvement in existing dryer used for (pulses) to achieve maximum heat transfer rate

Amit A. Gulalkari¹, Prof. Vijay G. Gore²

¹. Final Year M.E. Mech.Engg.(Thermal Engineering), P.R Pote (Patil) College of Engineering and Management, Amravati.

². Assistant Professor, P.R Pote (Patil) College of Engineering and Management, Amravati.

-----***-----

Abstract

The dryer is the equipment used for dry the grains, pulses etc. by higher rate of heat transfer the dryer suck the wet particles of grains or pulses and convert in to dried grains or dried pulses.

The existing dryer having inlet temperature 110°C at ash hole cabinet and at the outlet temperature at dryer cabinet is to obtained near to 65°C. In this, we observed that the high temperature difference at inlet and outlet of the existing dryer. Further we use some heat transfer concept for improving the outlet temperature of the dryer cabinet. In this paper, we work on the inlet condition of dryer, number of existing tubes, its primary effect on outlet temperature etc. by the application of CFX solver and ANSYS.

In this paper the batch type dryers are also included. Although these dryer has certain advantages, their high initial and operating costs have thus far prevented market penetration. Simulation modeling is routinely used today in the industry for analysis and design, resulting in their improved grain-quality and energy-efficiency characteristics.

Introduction

1. Background

In general Scenario, the economies of proper harvest scheduling are evident, making a strong case for early harvest the drying decision is not always a matter of choice. This is particularly true in the northern climates with short growing seasons, or in high humidity area of world. Pulses dries about 0.25 % a day from time it dents until it reaches about 25% moisture. It is normally unaffected by whether at this stage. However, below this point, whether is a major factor. Pulses in the 20-25% range dries at an average 0.50 % a day if whether is favorable. If high humidity condition persists, it can take more than a month. In some wet season it may not dry at all, but remain at high moisture content.

The artificial drying using the dryers is a sound approach to improving profit. The livestock producers has the alternative of holding and ensiled product, and he must weigh the economic advantages of each system; but as long as grain is stored, marketed and transported in a relatively low moisture condition, the only currently viable solution for the practical handling of the grain in volume is found in artificial drying. In this given circumstances, therefore, the challenge before the producer and the industry is to maximize the

efficiency of drying techniques. This paper is overview of to improve the efficiency of the dryer so that maximum quantity of grains can be dried at a very large scale by comparatively burning less fuel.

2. Objectives & Steps

In this we mainly work for analysis and design improvement in the existing dryers used for pulses to achieve maximum heat transfer rate.

The present investigation is aimed as:

Analysis of outlet temperature improving in the existing batch type dryers. Preparation of the model using the software named CATIA for the analysis. Formulating the model in ANSYS software named CFD for the flow calculation. Sorting out those problems which are affecting the efficiency of the system. Suggesting the changes to be done to achieve maximum temperature at the outlet of the system.

Overview of Existing System

1. Existing Dryer

There is exist assembly of duct, hoppers, combustion chamber, tubes etc. use for drying the pulses having inlet temperature 110°C at ash hole cabinet and at the outlet temperature at dryer cabinet is to obtained near to 65°C .



Fig.01 Assembly of Existing Dryer
2. Duct

Ducts are used in heating, ventilation, and air conditioning to deliver and remove air. The needed airflows include supply air, return air, and exhaust air. Ducts commonly also deliver ventilation air as part of the supply air. As such, air ducts are one method of ensuring acceptable indoor air quality as well as thermal comfort. Planning, sizing, optimizing, detailing, and finding the pressure loss through a duct system is called duct design. A duct system is also called ductwork. In the batch type dryer the hopper and dryers are connected with the help of ducts to transfer the hot air from dryer to the hopper where the grains are kept for drying.



Fig.02 Duct

3. Industrial Hopper

In the batch type dryer the hoppers are used to collect the grains where the hot air coming from the dryers are allowed to pass through it. Hoppers have capacity to hold tones of grains at a time for drying. Hoppers are the storage container used to dispense granular materials through the use of a chute to restrict flow, sometimes assisted by mechanical agitation. Hoppers are used to collect granular materials designed to easily dispense these materials through the use of gravity.



Fig.03 Industrial Hopper

4. Combustion Chamber

Combustion chamber is place where the combustion of the fuel takes place inside the dryer generally the fuel can be of any type such as wood, coal etc. Due to combustion of the fuel the heat is evolved which is used to carry on the further process of the drying of the pulses. In most of the dryers the combustion chamber is located in connection with the dryers. In batch type dryer the combustion chamber is located below the whole arrangement.



Fig.04 Combustion Chamber

5. Tubes

The tubes are the hollow parts which are used to transfer the working fluid from one point to another. In this batch type dryers the tubes are 24 in number. The tubes in dryers are arranged in bundle shaped and are used to transfer heat. These twenty four numbers of tubes are made up of Galvanized Iron. The diameter of tubes plays very important role in heat transfer of the system.



Fig.05 Tubes

Methodology

This part consists of the modeling of Existing Dryer with CATIA and analysis of Existing Dryer with CFD.

1. Design Assembly of existing dryer

For analyzing the maximum outlet temperature of the system it is necessity to make the assembly of existing system. In the figure shows the assembly of required component for experiment of existing dryer.

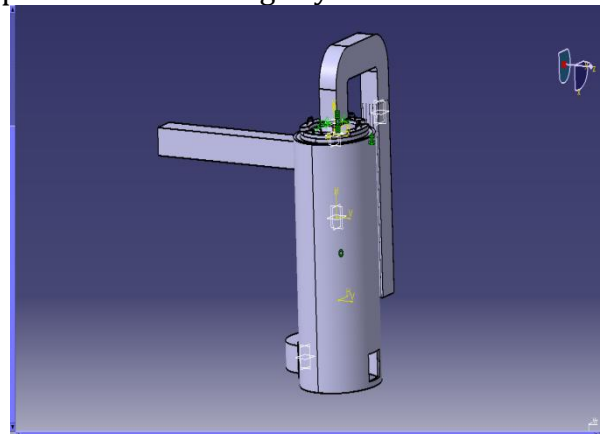

Fig.06 Model Assembly of existing Dryer

2. Result of existing dryer

FILE REPORT

Table 01: File information for CFX

Case	CFX
Case Type	CFX5
Case Version	14.5

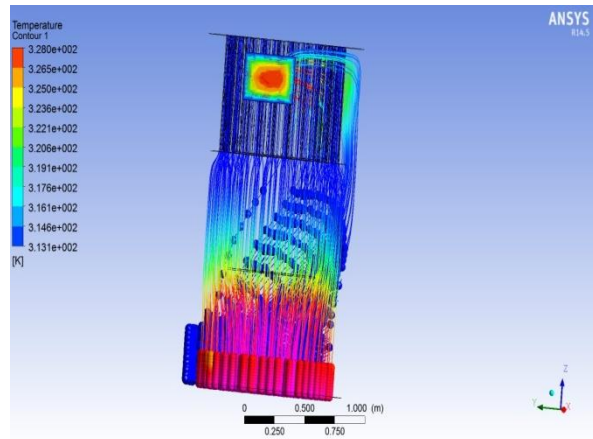

Fig.08 Counter Effects at Cold Outlet

MESH REPORT

Table 02 Mesh Information for CFX

Domain	Nodes	Elements
Cold Domain	45311	239462
Hot Domain	15845	62340
Idle Domain	2994	15038
All Domains	64150	316840

3. Effect on outlet temperature by changing tube diameter

First of all, we consider the effect of varying tube diameter on existing dryer condition i.e. we vary tube diameter by having 24 numbers of tubes, which gives us following readings.

Table 03 Readings for varying diameter at 24 no. of tubes

Tube diameter	Temperature
3	339.705
2.5(existing)	339.957
2.2	340.127
2	340.247
1.8	340.371

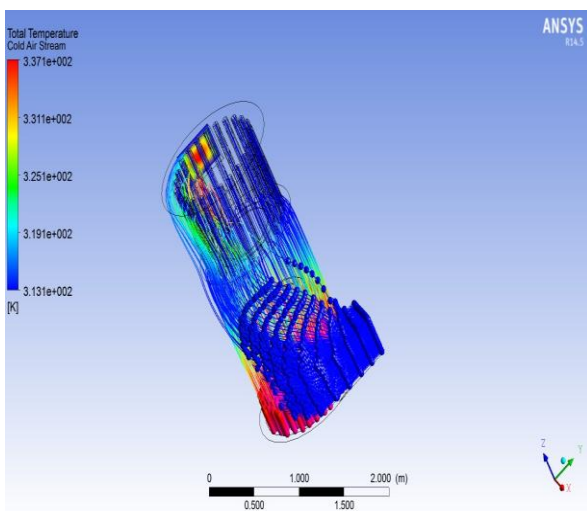

Fig.07 Existing Dryer Stream Flow

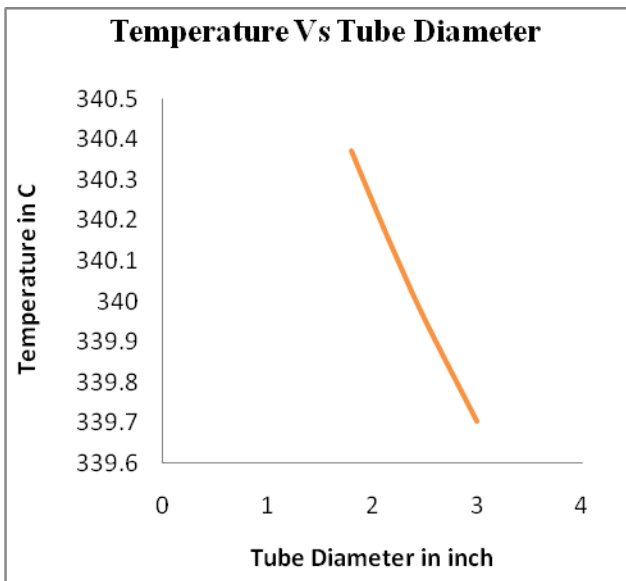

Fig.09 Comparative Study of Diameter of tubes and numbers of tubes

As we are getting maximum temperature at the tube having diameter of 1.8 inch diameter so here we change numbers of tube to get maximum temperature at same diameter .Readings are as follows:-

Table 04 Readings

No. of tubes	Temperature
18	337.79
24	340.371
30	337.412

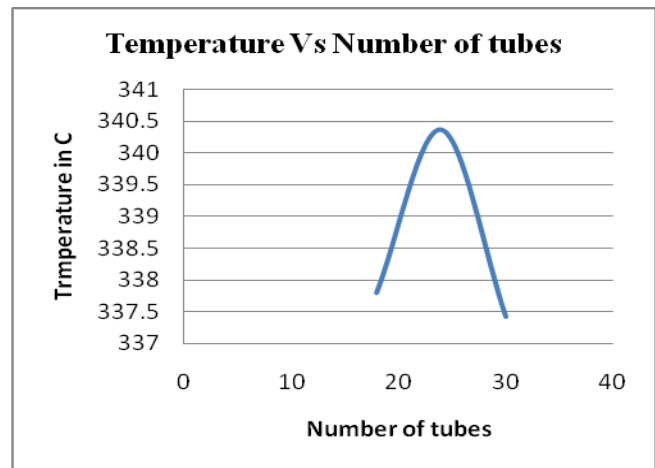

Fig.11 Comparative study of temperature and number of tubes at tube diameter of 1.8 inches

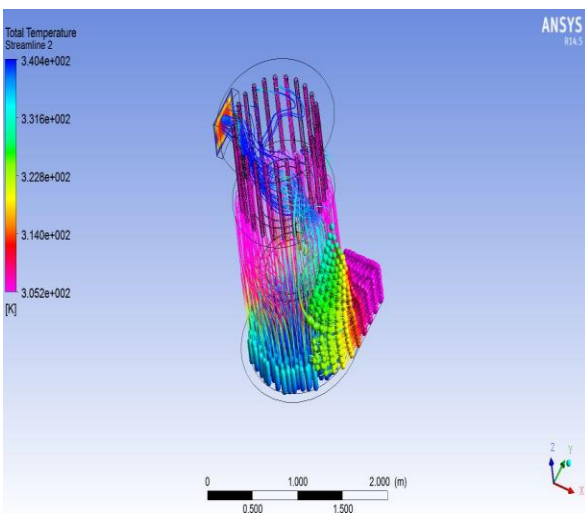

Fig.10 Existing Dryer Stream Flow

From the above graph, we can conclude that with the increase in diameter of the tube there is a decrease in temperature.

Here we get 340.371 C as a maximum temperature for the tube having diameter of 1.8 inch.

4. Effect on outlet temperature by changing the number of tubes

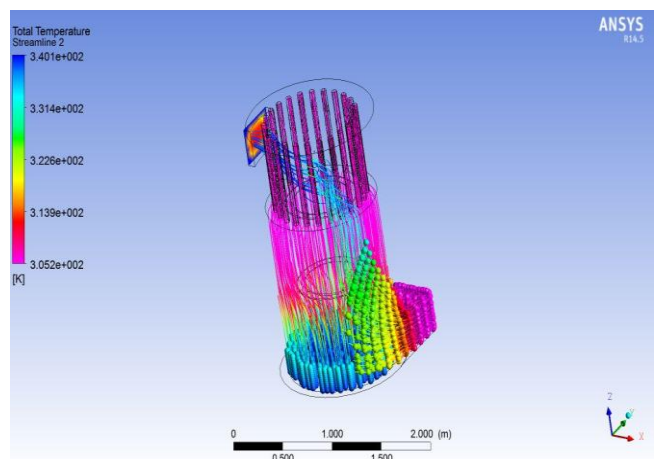

Fig.12 Flow of Air at 24 numbers of tubes

Again from the above graph we can conclude that with the increment in number of tubes or with the decrement of number of tubes from 24, we are getting fall in temperature as shown by the curve in above graph. Thus the optimum conclusion could be stated as keeping no. of tubes as 24 with a tube diameter of 1.8 inches, the system could yield a maximum temperature as shown above.

Conclusion

On the basis of the aforesaid results, it could be analytically concluded that the existing design is optimal enough to perform various tasks which it is design for. The results which are obtained after analyzing the existing design for difference condition i.e. Change in tube diameter, change in no. of tube, differ very less with the existing values. Yet, the difference in the value could be considered as positive and hence, we conclude by saying that the result obtained could be adapted and an increase in output temperature could be yielded. The change in design i.e change in tube diameter from 2.5 inches to 1.8 inches, leads the system to an increase in temperature by 0.414 C. The increase could be calculated as 0.17%. A general model is so far limited to duct flow configuration, but may easily be extended to other flow configurations, due to its born generality.

Efficient and clean drying is provided by this system irrespective of the whether outside. Hence in future, instead of being dependent on conventional heat energy of sun, this method could prove beneficial.

Reference

- [1] Chinnock, P.S., Page, R.H., "Turbulent Heat Transfer with a SOJIN, Proceedings of the International Symposium on Turbulence," Heat and Mass Transfer, Lisbon, Portugal, 1994
- [2] De Beers, J., Worrell, E., Blok, K, "Long-Term Energy-Efficiency Improvements in the Paper and Board Industry," Energy, 1998
- [3] Devahastin, S., Mujumdar, A.S. "Batch Drying of Grains in a Well-mixed Dryer-Effect of Continuous and Stepwise Change in Drying Air Temperature," Transactions of the ASAE, 1999
- [4] Hosseinalipour, S.M., Mujumdar, A.S., "A Model for Superheated Steam Drying of Particles in an Impinging Stream Dryer," 1997
- [5] Jumah, R.Y., Mujumdar, A.S., Raghavan, G.S.V., "Batch Drying Kinetics of Corn in a Novel Rotating Jet Spouted bed," Canadian Journal of Chemical Engineering, 1996
- [6] Masters, K., "Full Containment Spray Drying," Drying Technology-An International Journal, 1995
- [7] Shah, R.M., Arora, P.K, "Two Fluid Nozzles and their Application in Spray Drying of E-PVC," 1996
- [8] A.S. Mujumdar (Ed.) Drying'92, Vol. 1, Elsevier, Amsterdam, 1992
- [9] Foster, R., Innovation - The Attacker's Advantage, Summit Books, New York.
- [10] Gawrzynski, Z., Glaser, R., 1996, "Drying in a Pulsed-Fluid Bed with Relocated Gas Stream," Drying Technology-An International Journal, 1986

[11] Mujumdar (Ed.) Handbook of Industrial Drying, 2nd Edition, Marcel Dekker, New York.

[13] Kudra, T., Mujumdar, A.S., 2000, "Advanced Drying Technologies," Marcel Dekker, New York, 1995

[14] Howard, W.G., Guile, B.R. (Eds.), Profiting from Innovation, the Free Press, New York, 1992

[15] A.S. Mujumdar (Eds.), "Mathematical Modeling and Numerical Techniques in Drying Technology," Marcel Dekker, New York, 1997

BIOGRAPHIES



1. Final Year M.E. Mech.Engg. (Thermal Engineering), P.R Pote (Patil) College of Engineering and Management, Amravati.



2. Assistant Professor, P.R Pote (Patil) College of Engineering and Management, Amravati.