

Semi Physical Modeling and Control of Nonlinear System Using Soft Computing Technique

M. Sridevi¹, P.Madhava Sarma², P.Veeraragavan³

1 Department of Electronics And communication engineering, Vels university Pallavaram Chennai 600043

2 Department of Electronics & Communication Engineering, Saraswathy College of Engineering & Technology, Tindivanam 604307

3 Department of physics, University College of engineering, A constituent college of Anna University, Tindivanam – 604307.

ABSTRACT

In Chemical industries level control of non linear interacting and non interacting systems is on huge demand due to multivariable process interactions. In this work a non linear liquid level process represented by a 40 liter four non interacting spherical tank was subjected to dynamic analysis. The data was identified to be non linear and approximated to first order model with an error of less than 5 percent. The level was measured using on-line Honeywell capacitance sensor. From the model parameters, PI and fuzzy tuned PI Controller s were designed using MATLAB. The closed loop performance was studied for both servo and regulator problems. Based on overshoot, rise time, settling time, and ISE, it is found that the Fuzzy tuned PI controller is better suited for this process.

Keywords: *Fuzzy logic, PI, nonlinear, spherical*

INTRODUCTION

In many process involving liquid contained in vessels, such as distillation columns, reboilers, evaporators, crystallizers and mixing tanks, the particular level of liquid in each vessel is of great importance in process operation. A level which is too high upsets reaction equilibrium, causing damage to equipment, results in spillage of valuable or hazardous material. A level that is too low also has bad consequences. Hence there is need for sensitive and accurate level control. Effective measurement and control of level usually justified in terms of economy and safety.

In many process applications, the level must be maintained accurately at a predetermined height, irrespective of load conditions of the process. Continuous process may incorporate accumulators or storage vessels in line to provide storage. Process upsets or disturbances are absorbed in such accumulators without passage down-line, which will result in a better overall control.

Moreover recent times four tank systems study has attracted due to multivariable, interactions, transmission the nonlinear systems are modeled by linearizing the non linearity over certain input region. Radhakrishnan et al [1-3] has analyzed systems with time delay and developed model-based tuning methods. Madhavasarma et al [4-11] have designed control system for nonlinear process. Neelemagam et al [12] have developed control system using micro controller for ionic solution. Munoz et al [13] has designed electrical conductivity measurement for KCl solution. Lu et al [14] has discussed uncertainty in chemical sensor. Tse et al [15] have developed a model using neural network algorithm for air handling unit. Karacan [16] has used neural networks to extend the capacity of linear MPC to control nonlinear systems. Sivakumaran et al [17] has developed fuzzy system for identification of a structure by means of parameter optimization. Silva et al [18] has designed a new NMPC algorithm for SISO and MIMO systems. Henrique et al [19] have modified the Elman network for higher order systems. Margraves et al [20] have detected the flaw in the engineering materials using neural networks. Srinivas et al [21] have developed fuzzy logic controller to control the dissolved oxygen in the fermentation process has also designed pH neutralization process using fuzzy logic controller. Gao et al [22] have designed stable fuzzy logic controller for industrial process. Quing et al explained about [23] Continuous cycling closed loop method is widely used for establishing

model parameters. Li [24] proposed a method to study Fuzzy logic control combined with conventional PID controller. Hans [25] discussed enhanced fuzzy model with special membership function and control rules based on expert knowledge and the control algorithms can be implemented without any computational problems. Ram Kumar et al. [26] has also proposed PI control strategy which incorporates a PI tuned fuzzy logic controller to provide compensation for nonlinearity in the process. Chidambaram et al. [27] discussed the experimental verification of a controller based on variable transformation. A fuzzy tuned PID controller has been suggested for a linear process represented by a first order plus dead time process. Ying et al [28] analyzed controller that uses error and change in error as input variables. Khoei et al [29] describes the design principle, tracking performance of a fuzzy controller. The above Literature does not report model identification using semi physical modeling techniques for four tank system. [30] This work aims at designing a semi-physical model of four nonlinear non interacting systems to study the behavior of the system to the input flow rate. A mathematical model is derived to obtain the transfer function of the system. [31] A PI based fuzzy controller is designed to overcome the shortcomings of PI controller. The performance of fuzzy controller is compared with PI and it is shown that the fuzzy controller exhibits a better control action for the system.

SEMPHYSICAL MODELING OF SPHERICAL TANK

The semi physical model is derived based on the principle of conservation of total mass. The level dynamics of the system described by differential equation arising from the conservation of total mass in the system is used for the development of semi-physical model. MATLAB with simulink is used to develop the semi physical model describing the effect of various system inputs on the level. The derivation of a semi physical model is done assuming constant volume of the tank [32,34] and constant densities for all streams. For single Spherical tank semispherical modeling is represented by the following equation 1

$$\text{Volume } V = \frac{\pi h^2 (3R-h)}{3} \tag{1}$$

Where, h = Height of Liquid in Tank, R = Radius of the Tank
From the mass balance equation:

$$\text{Mass input} = \text{mass output} + \text{accumulation} \tag{2}$$

$$\rho Q_i = \rho Q_0 + \rho \frac{dv}{dt}$$

Where ρ = density of the liquid

$$\text{Or, } Q_i - Q_0 = \frac{dv}{dt}$$

Where Q_i = Input Flow Rate, Q_0 = Output Flow Rate = $ch^{0.5}$

$$\text{Hence, } \frac{dv}{dt} = \pi(2Rh-h^2) \tag{3}$$

⇒

$$\pi(2Rh-h^2) \frac{dh}{dt} = Q_i - ch^{0.5}$$

⇒

$$\frac{dh}{dt} = \frac{-ch^{0.5}}{\pi(2Rh-h^2)} + \tag{4}$$

⇒

$$\frac{dh}{dt} = f(h, Q_i) \tag{5}$$

We have derived a relation between height and input flow rate using equation 2 semi physical model via simulink was developed which is shown in figure 1.

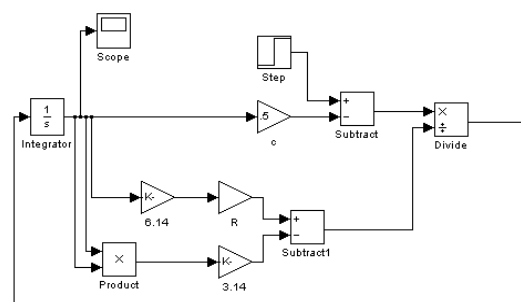

Figure-1 Semiphysical model of tank

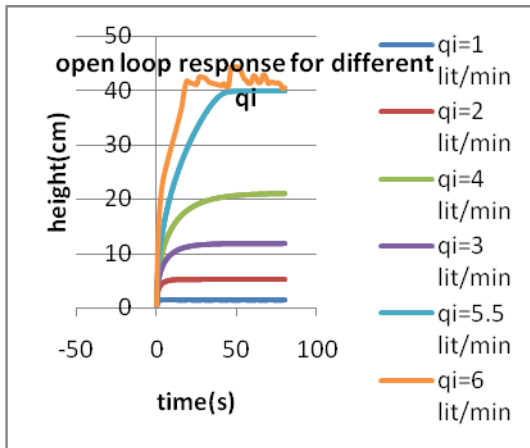

FIGURE 2 Open Loop Response for Different Qi

The level obtained for different flow rates using the semi-physical model is as shown in figure 2. It is inferred from the figure 2 the height is proportional to inflow, and as inflow increases the height at which the liquid level settles in the tank increases and as the inflow exceeds 5.5 lit/min the settling height exceeds 40 cm i.e. the tank height and hence it overflows.

Modeling of Non Linear Spherical Tank Process

The non linear spherical tank [33] system shown in Figure3. The mathematical modeling equation for single spherical tank process is described below.

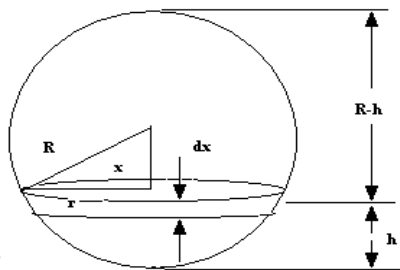

Figure-3 Spherical tank

From the figure3, it is clear that

$$V = \int_{-R}^{-R+h} \pi(R^2 - x^2) dx \tag{6}$$

$$V = \int_{-R}^{-R+h} \pi r^2 dx$$

$$= \pi(R^2 x - x^3 / 3) \Big|_{-R}^{-R+h}$$

On substituting the values of limit the volume of the tank is obtained and shown in equation 7

$$V = \frac{\pi h^2(3R-h)}{3} \tag{7}$$

Where, h = Height of Liquid in Tank, R = Radius of the Tank
From the mass balance equation:

$$Q_i = Q_0 + \frac{dv}{dt} \tag{8}$$

$$\text{Or, } Q_i - Q_0 = \frac{dv}{dt} \tag{9}$$

Where Q_i = Input Flow Rate
 Q_0 = Output Flow Rate = $ch^{0.5}$

$$\text{Hence, } \frac{dv}{dt} = \pi(2Rh-h^2) \frac{dh}{dt}$$

$$\Rightarrow \pi(2Rh-h^2) \frac{dh}{dt} = Q_i - ch^{0.5}$$

$$\Rightarrow \frac{dh}{dt} = \frac{-ch^{0.5}}{\pi(2Rh-h^2)} + \frac{Q_i}{\pi(2Rh-h^2)}$$

$$\Rightarrow \frac{dh}{dt} = f(h, Q_i) \tag{10}$$

We know that from Taylor's Series:

$$\frac{dh}{dt} = f(h_s, Q_s) + \frac{\partial f}{\partial h} \Big|_{(h_s, Q_s)} (h - h_s) + \frac{\partial f}{\partial Q} \Big|_{(h_s, Q_s)} (Q - Q_s) + \frac{\partial^2 f}{\partial h^2} \Big|_{(h_s, Q_s)} (h-h_s)^2 / 2! + \dots \tag{11}$$

Now we have:

$$\Rightarrow f(h, Q_i) = \frac{-ch^{0.5}}{\pi(2Rh-h^2)} + \frac{Q_i}{\pi(2Rh-h^2)}$$

Hence,

$$\frac{\partial f}{\partial h} = \frac{\frac{-c}{2 \cdot h^{1.5}} \{ \pi(2Rh-h^2) \} + c \cdot h^{0.5} \{ \pi(2R-2h) \}}{(\pi(2Rh-h^2))^2} +$$

$$\frac{\pi(2R-2h) Q_i}{(\pi(2Rh-h^2))^2}$$

$$\frac{\partial f}{\partial Q} = \frac{1}{\pi(2Rh-h^2)}$$

Hence,

$$\frac{\partial f}{\partial h} |_{(h_s, Q_s)} = \frac{[-\bar{c}(2Rh - h_s^2) + 2\bar{c}(2R - 2h) - Q_s(2R - 2h_s)]}{(2Rhs - h_s^2)^2}$$

$$\frac{\partial f}{\partial Q} |_{(h_s, Q_s)} = \frac{1}{\pi(2Rhs - h_s^2)}$$

Where $\bar{c} = \frac{c}{2 * h_s^{0.5}}$

And c = coefficient of discharge = 0.6

Putting the above values in Taylor's series we get

$$\Rightarrow \frac{dh}{dt} = \frac{-ch^{0.5}}{\pi(2Rh - h^2)} + \frac{Q_i}{\pi(2Rh - h^2)} - (h - h_s) \frac{\partial f}{\partial h} |_{(h_s, Q_s)} + (Q_i - Q_s) \frac{\partial f}{\partial Q} |_{(h_s, Q_s)} \quad (12)$$

But at steady state,

$$\frac{-ch^{0.5}}{\pi(2Rh - h^2)} = 0$$

And $(Q_i - Q_s) \frac{\partial f}{\partial Q} |_{(h_s, Q_s)} = 0$

So we form equation 1 as:

$$\frac{d(h - h_s)}{dt} = \frac{Q_i}{\pi(2Rh - h^2)} - \frac{(h - h_s) [-\bar{c}(2Rh - h_s^2) + 2\bar{c}(2R - 2h) - Q_s(2R - 2h_s)]}{(2Rhs - h_s^2)^2} - \frac{Q_s(2R - 2h_s)}{\pi(2Rhs - h_s^2)^2}$$

$$\Rightarrow \frac{dh}{dt} = -h \quad A \quad + \quad BQ_i \quad (13)$$

Where A and B represent the constant terms in equation 13;

Taking Laplace transform for the equation 13;

$$s H(s) = -A H(s) + B Q(s)$$

Or, $\frac{H(s)}{Q(s)} = \frac{B}{s+A}$

(14)

Since Radius = 0.20m.

Putting $h_s = 0.11m$.

We get,

$$\frac{H(s)}{Q(s)} = \frac{9.975}{(s + 9.0228)}$$

(15)

Since we have $Q_0 = ch^{0.5}$

Hence,

$$\frac{Q_0(s)}{Q(s)} = \frac{9.0228}{(s + 9.0228)} \quad (16)$$

The above expression gives the mathematical model transfer function for a single spherical tank. But we are considering the case of a 4 tank non-interacting system; its transfer function is obtained as shown in equation 17.

$$\frac{H_4(s)}{Q_i(s)} = \frac{Q_1(s)}{Q_i(s)} * \frac{Q_2(s)}{Q_1(s)} * \frac{Q_3(s)}{Q_2(s)} * \frac{H_4(s)}{Q_3(s)}$$

Hence substituting the value for $h_s = 0.11m$:

$$\frac{H_4(s)}{Q_i(s)} = \frac{7.327 * 10^3}{s^4 + 36.085s^3 + 488.16s^2 + 2935s + 6620.9} \quad (17)$$

EXPERIMENTAL

Figure 4 shows the experimental setup to study the dynamics of the non linear process. A Honeywell sensor was used to monitor the level. A system with suitable interface was connected to the level sensor

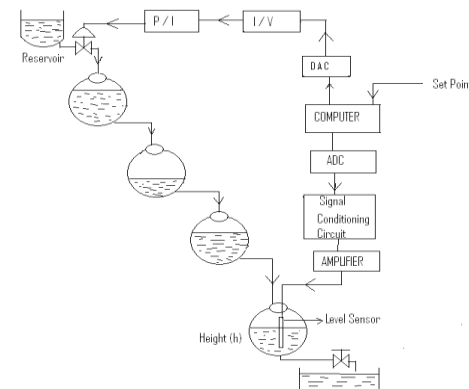

FIGURE-4 Experimental setup Collection tank

EXPERIMENTAL PROCEDURE

The process flow model was determined experimentally by open loop analysis. The flow rate of water at the inlet was fixed at 1 LPM. A step change in water flow rate from 3LPM to 4LPM was introduced and change in level was recorded. The experimental results are shown in Figure 5.

PROCESS IDENTIFICATION

The data in Figure 5 was fitted to a first order plus dead time model given in equation 18 for the FOPDT model of the process.

$$G_p(s) = \frac{K_p e^{-\tau_d s}}{\tau s + 1} \quad (18)$$

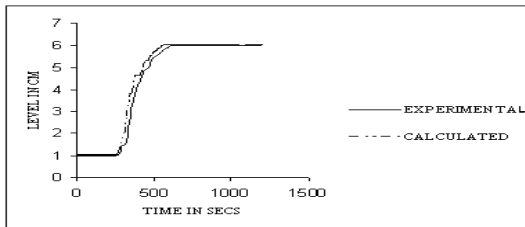

FIGURE -5 Comparison of Experimental and Calculated values

PI CONTROLLER FOR THE 4 TANK PROCESS

A system consisting of a plant and a controller with unity feedback is shown in Figure 6. The controller output was given to 4 tank process. The PI controller optimum settings such as the critical gain (K_u) = 0.35, critical period (P_u) = 2.625, Proportional gain (K_c) = 0.645 and integral gain (K_i) = 2.875 were obtained by Ziegler Nichols tuning method.

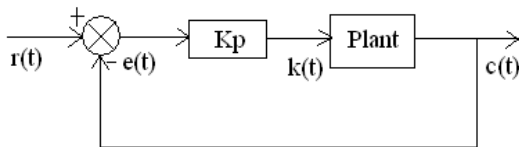

FIGURE-6 Schematic diagram for PI controller

The open loop transfer function for a four tank non interacting system is obtained in equation 17. It is shown in equation 19 for controller tuning setting purpose.

$$\frac{H(s)}{Q(s)} = \frac{7.327 * 10^3 * e^{-5s}}{s^4 + 36.085s^3 + 488.16s^2 + 2935s + 6620.9} \quad (19)$$

$$= \frac{7.327 * 10^3 (s-2.5)}{(s^4 + 36.085s^3 + 488.16s^2 + 2935s + 6620.9)(s+2.5)}$$

Hence, the closed loop transfer function with gain 'k' is:

$$\frac{H(s)}{Q(s)} = k \frac{G(P)}{1+kG(P)} \quad (20)$$

Thus, the characteristic equation of closed loop transfer function is:

$$1 + kG(P) = 0$$

$$\Rightarrow 1 + \frac{k * 7.327 * 10^3 (s-2.5)}{(s^4 + 36.085s^3 + 488.16s^2 + 2935s + 6620.9)(s+2.5)} = 0$$

$$s^5 + 38.58s^4 + 578.3s^3 + 4155s^2 + 13957s + 7327ks + 16550 - 18317.5k = 0 \quad (21)$$

Thus, forming the Routh Array to solve for 'k':

s^5	1	578.3	13957 + 7327k
s^4	38.5	4155	16550 - 18317.5k
s^3	470.4	13527 + 666k	0
s^2	3048 - 54.5k	16550 - 18317.5k	0'''
s^1	$\frac{(-36297k^2 + 9909298k + 33445176)}{(3048 - 54.5k)}$	0	0

s^0	16550 18317.5k	-	0 0

So, we have for the Stability of the system all elements of the first column of

$$\Rightarrow 16550 - 18317.5k > 0$$

$$\Rightarrow k < 0.90$$

$$\text{Also } \frac{(-36297k^2 + 9909298k + 33445176)}{(3048 - 54.5k)} > 0$$

$$\Rightarrow -3.33 < k < 276$$

$$\text{Also } 3048 - 54.5k > 0$$

$$\Rightarrow k < 55.9$$

From the above three conditions we get range for k as
 $-3.33 < k < 0.90$
 (22)

From the equation 22 we select $k(=K_u)$ as 0.778 Hence $K_p = 0.45$ $K_u = 0.35$ From this $K_p = 0.35$ In Matlab simulation of model ultimate gain is used which causes the sustained oscillation in output. Using this frequency of oscillation it is found that $P_u = 2.625$ Hence $T_i = P_u / 1.2 = 2.875$, $K_i = K_p / T_i = 0.16$

DESIGN OF FUZZY LOGIC CONTROLLER

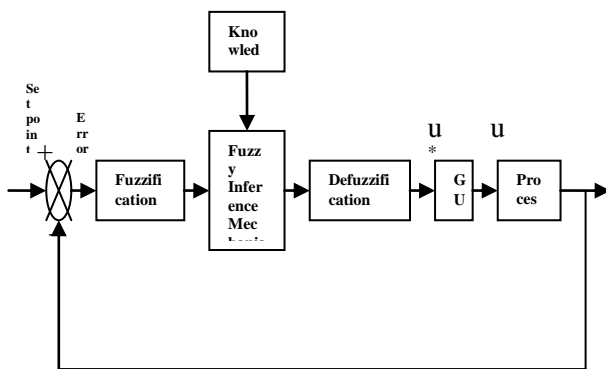

FIGURE-7 Fuzzy control structures

A fuzzy logic control has four blocks as shown in Figure 7. Crisp input information from the device is

converted into fuzzy values for each input fuzzy set with the fuzzification block. The universe of discourse of the input variables determines the required scaling for correct per unit operation. The scaling is very important because the fuzzy system can be retrofitted with other device or ranges of operation by just changing the scaling of the input and output. The decision making logic, fuzzy inference, determines how the fuzzy logic operations are performed and together with knowledge base determines the outputs of each fuzzy if-then rules. These are combined and converted to crispy values with the defuzzification block. The output crisp value can be calculated by the center of gravity method. Six steps are involved in the creation of a rule based fuzzy system to process the input to get the output reasoning. The inputs and their ranges are identified and named. The outputs and their ranges are identified and named. The degree of fuzzy member function for each input and output is created. The rule base that the system will operate is constructed. Decision on the execution of action by assigning strengths to the rules is made. The rules are combined and the output is defuzzified.

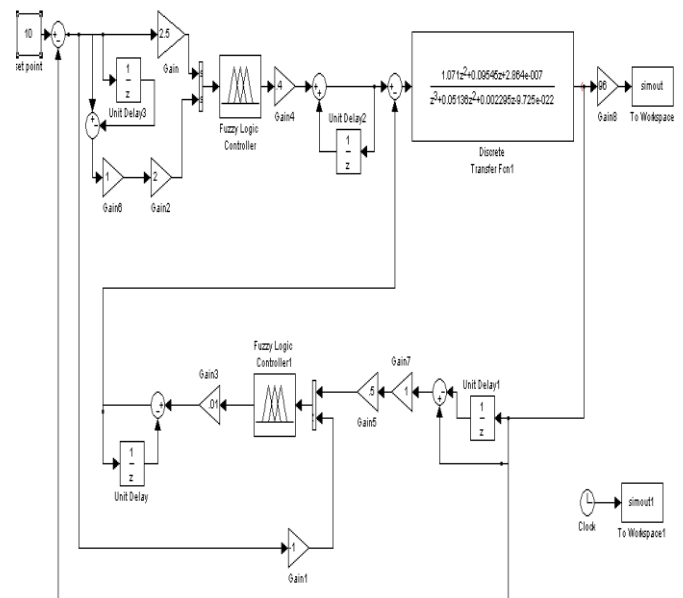

FIGURE-8 Block diagram of Mamdani type fuzzy control system

The block diagram of mamdani type fuzzy control is shown in Figure 8. The fuzzy logic controller was developed here

using two input variables E (Error) and CE (Change of error) and one controller output. The inputs E and CE are directly fed to the mamdani type fuzzy controller. Each of these variables have 3 membership functions which are labeled as NB-negative big NH-negative high, NS-negative small,

MEMBERSHIP FUNCTION DISTRIBUTION

First, the fuzzy PI controller is derived from the conventional continuous-time linear PI controller. Then, the fuzzification, control-rule base, and defuzzification for the design of the fuzzy controller are designed. The resulting controller is a discrete-time fuzzy version of the conventional PI controller, which has the same linear structure in the proportional, integral and derivative parts but has non-constant gains. The design involves the assigning of membership function to the parameters i.e. error, change in error and output. The membership function is as shown in figure9 the range of membership value = {-40 40}for error and change of error range is -25 to +25and similarly the controller output range is -43 to +42.is shown in Figure 10and11.

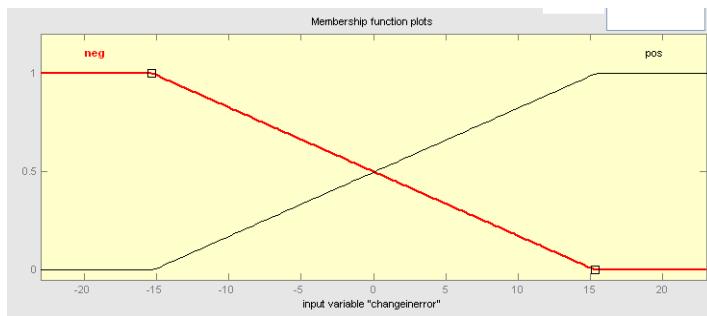

FIGURE-9 Membership function for Error

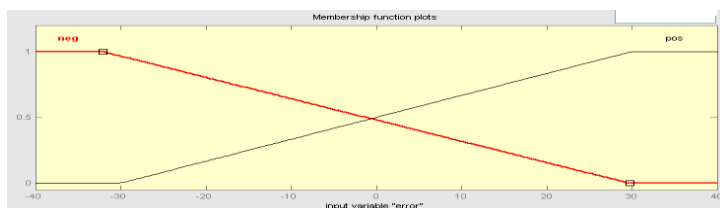

FIGURE-10 Membership function for change in error

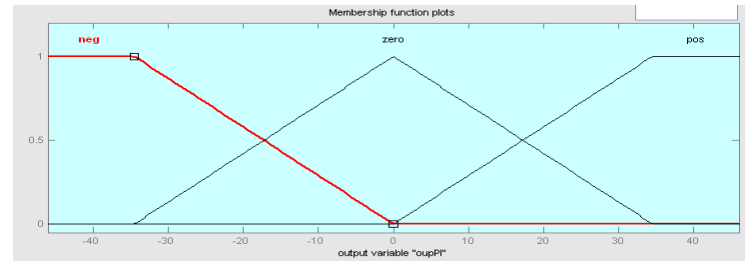

FIGURE-11 Membership function for output

RESULT & DISUSSION

The fuzzy logic controller is designed and applied to real time control of spherical tank liquid level system. To evaluate closed loop performance of the PI controller for the spherical tank process step change in the set point are introduced .Servo response to set point change of various units level was given for the process is shown in Figure 12.To evaluate closed loop performance of the Fuzzy PI controller for the spherical tank process step change in the set point are introduced .Servo response to set point change of various units level was given for the process is shown in Figure13. The comparision response of fuzzy and Pi controllerfor a single set point is shown in figure14and controlller comparision for differnt set point is shown in Figure 15.FUZZY tuned PI controller provides better time domain performance such as faster settling time and rise time and offers less over shoot. Since time delay has been removed from the denominator of set point transfer function, the smith predictor offers good ISE values for set point change and load change

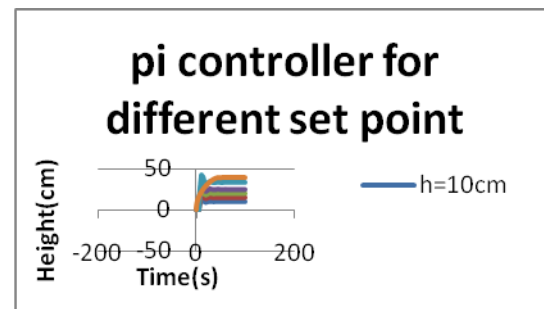

FIGURE-12 PI controller output response for different set point

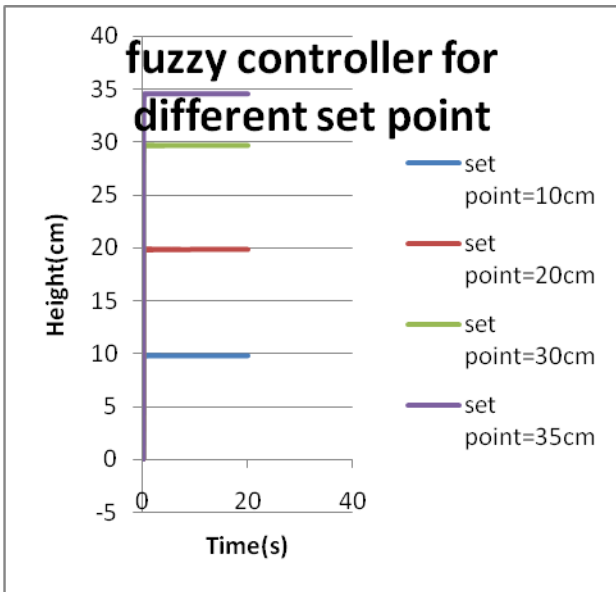

FIGURE-13 FUZZY controller output for different set point

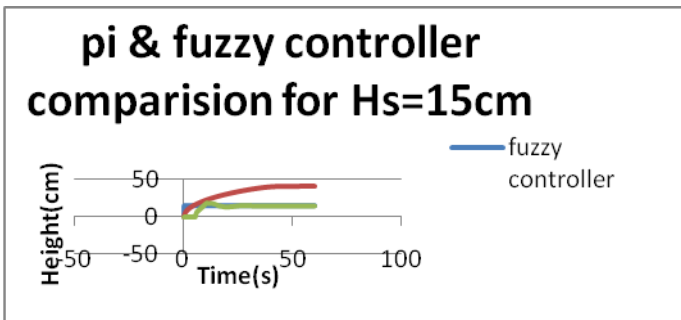

FIGURE-14 PI and FUZZY controller out put response for single setpoint

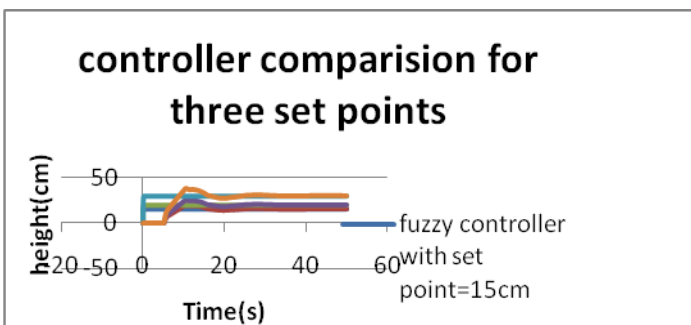

FIGURE-15 PI and FUZZY logic Comparison

TABLE-1 Controller performance

Control ler	Rise time(s)	Settling time (s)	Peak time(s)	Ove rshot (%)
FUZZY	0.15	1.06	0.31	0.5
PI	8.9	35	10.55	27.1

CONCLUSION

The results given in Table 1 emphasize that the Fuzzy PI controller shows a minimum dynamic response time than the conventional PI controllers. While conventional PI controllers reach the set point smoothly, fuzzy PI controllers possess a sharp curve like responses. This response is attributed to the non linearity of the fuzzy system. Fuzzy controller's shows minimum rise time compared to conventional controllers, it is also note down from the result of fuzzy controller over shoot is very low for the 4 tank spherical process

REFERENCES

- [1] J. A Vijayaselvi, T. K Radhakrishnan, S .Sundaram, Performance assessment of PID and IMC tuning methods for a mixing process with time delay, (2007). ISA, 46, 391-397.
- [2] J.A Vijayaselvi, T.K Radhakrishnan, S Sundaram, Model based IMC controller for process with dead time. Instrum.Sci&Technology. (2006). 34, 463-474.
- [3] S Soundaravalli, T.K Radhakrishnan, S. Sundaram, Model based tuning of

- humidifying process with transportation lag. Instrum.Sci&Technology, (2006). 35, 153-162.
- [4] P .Madhavasarma, S.Sundaram, Model based tuning of controller for non linear hemispherical tank processes. Instrum. Sci&Technol. 2007, 35, 681-689.
- [5] P .Madhavasarma, S.Sundaram, Model based tuning of controller for non linear spherical tank processes. Instrum. Sci&Technol. 2008, 36, 420-431.
- [6] P .Madhavasarma, S.Sundaram, Model based evaluation of controller using flow sensor for conductivity process.. J. Sensors & Transducers, 2007, 36, 420-431.
- [7] P .Madhavasarma, S.Sundaram, Leak Detection and Model Analysis for Nonlinear Spherical Tank Process Using Conductivity Sensor. J. Sensors & Transducers, 2008, 89, pp. 71-76.
- [8] [08] M.Sridevi, P.Madhavasarma, P.Prakasam, Model identification of nonlinear System Soft Computing Techniques, TIMA proceedings of the international Conferences, 2013, 180- 183.
- [9] [09] M.Sridevi, P.Madhavasarma, P.Prakasam, Model identification of nonlinear Systems Using soft computing Techniques, IEEE explore, 2014, 1174-1178.
- [10] [10] M.Sridevi, P.Madhavasarma, P.Prakasam, Model identification and control of Spherical tank process using soft computing method. J. Sensors & Transducers, 2012,145, 10, pp,41-49.
- [11] [11] M.Sridevi, P.Madhavasarma, P.Prakasam, Modeling and control of Smart Structure using soft computing method. J. Sensors & Transducers, 2012,145, 10, pp. 10-18
- [12] [12] Rajenderan, P. Neelamegam, Measurement of conductivity of liquids using AT89C55WD microcontroller, Measurement (2004), 35, 59-63.
- [13] [13] D.R Munoz,, S.C Berga, An analog electronic interface to measure electrical conductivity in liquids Measurement (2005). 38,181-187.
- [14] T Lu, C. Chen, Uncertainty evaluation of humidity sensors calibrated by saturated salt solutions, Measurement (2007). 40,591-599
- [15] W.L Tse,, W.L Chan ,An automatic data acquisition system for on line training of artificial neural network- based air handling unit modeling, Measurement, , (2005). 37, 39-46.
- [16] S Karacen, Application of non -linear long range predictive control to a packed Distillation, hemical engineering and processing, (2003). 42,43-953.
- [17] N Sivakumaran, T.K.Radhakrishnan,.Identification and control of Bio reactor using recurrent neural networks, Instrum.Sci&Technology (2006)34,463-474
- [18] R.G Silva,. W.H.K Wong, Nonlinear Model predictive control of chemical Process, Braz.J.chemical Engineering, (1999) 16, 83-99.
- [19] J Henriques, P. Gill, A Douardo, H.D.Ramos , Applications of a recurrent neural network in on -line modeling of real time systems, Informatics engineering Department UC p'oloII 3030 Coimbra,Portugal(2001).
- [20] F.W Margrave,,Rigas, K Bradley, D.A Barrowcliffe, P. The use of neural networks in ultrasonic flaw detection, Measurement, (1999). 25, 143-154.
- [21] T; Srinivas, S Masoud, Mutharasan, R.Multirate nonlinear state and parameter

- estimation in a bioreactor. J Process system engineering, (1997), 674-680.
- [22] Z Gao, T.A Trautzsch, G, A James stable self tuning fuzzy logic control for an industrial temperature, IEEE Industry applications conference.2000, 12, 1232-1040.
- [23] W Quing-Guo Xin Guo,; Yong Zhang, Direct identification of continuous time delay systems from step responses, Journal of process control, 2001, Vol 11,531-542.
- [24] W.Li , Sign of a hybrid fuzzy logic proportional plus conventional integral-derivative controller", IEEE Trans. Fuzzy syst., 1998, Vol.6, no.4, pp.449-463.
- [25] M Hanss,. Identification of enhanced fuzzy models with special membership functions and fuzzy rule based Engineering applications of artificial intelligence, 1998, Vol 12, pp.309-319.
- [26] K.B Ram Kumar, M Chidambaram, A fuzzy self tuned PI controller for regulation of a nonlinear system, Bioprocess and Bio systems engineering, April 1995, Vol 12, 263-267.
- [27] M. Chidambaram, R Anandanatarajan. T Jayasingh. Controller design for non-linear process with dead time via variable transformation, proceedings of the international symposium on process system engineering and control, IIT Mumbai, 2003, 223-228.
- [28] H Ying, W, siler, J.J Buckely,.Fuzzy control theory: A non linear case, Automatica, 1990, vol.26, 513-520.
- [29] A Khoei, A.H Hadidi, M.R, Khorasani, R.Amirkhanzade, Fuzzy based controller chip to control the level of a tank Fuzzy sets and systems, 2005, Vol 150, 507-523.
- [30] V.H Nyttle, M Chidambaram,. Rule based fuzzy logic control. Bio-processor and Bio-systems, May 1993, Vol 9, .115-118.
- [31] J. Lee, on methods for improving performance of PI- type fuzzy logic controllers, IEEE Transactions on fuzzy system, 1993, Vol 1, 298-233.
- [32] D.R Coughanowr, Process System Analysis and Control, 2nded. McGraw Hill international Edition, Chem.Eng.Ser. ,1991, 283-302.
- [33] Bequette, W.B. Process Control, Modeling, design and Simulation: Prentice Hall of India Private Limited.2003:246-280.
- [34]. M.Sridevi, P.Madhavasarma. P.Prakasam Modeling and Control of Four Tank Spherical Systems Using Soft Computing Technique, International conference on mathematics and its applications (ICMAA 2014) villupuram.December 2014

BIOGRAPHIES



Dr.P.MadhavaSarma completed his Doctoral of Philosophy & M.Tech from REC Trichy and B.E from, Bharadhidasan University Trichy. He has published papers in 20 international journals and 8 national and international conferences. At present he is working as principal at Saraswathy College of Engineering and Technology. His area of interest is nonlinear control, soft computing, Control Systems



Sridevi.M completed her M.Tech from REC Trichy and B.E in Bharadhiyar University .She has published papers in international journals and 4ational and international conferences. At present working as Assistant Professor at Vel's university. Her area of research is nonlinear systems, Soft Computing.



P.Veeraragavan completed his P.G degree from Bhradhidasan University Trichy in 2005 U.G degree in physics from bhradhidasan university Trichy in 2003.and Mphil degree in 2010. At present he is working as teaching fellow University College of engineering tindivanam. His area of interest is medical physics, modeling, control.