

ANFIS-Based Bi-directional Grid Connected EV Charging Station With Battery Storage System

Mr. Chandra Shekhar Sahu¹, Mr. Vishwanath Prasad Kurmi², Miss. Preeti Sahu³

¹Department of Electrical Engineering, Dr. CVRU Kota Bilaspur Chhattisgarh, India

²Asst. Professor, Dept. of Electrical Engineering, Dr. CVRU Kota, Bilaspur, Chhattisgarh, India

³ Asst. Professor, Dept. of Electrical Engineering, Dr. CVRU Kota, Bilaspur, Chhattisgarh, India

Abstract - The need for contemporary transportation infrastructure is growing along with concerns about dangerous climatic changes and global warming. To resolve this issue, countries are promoting the use of Electric Vehicles (EVs). However, dependency on fossil fuel-based infrastructure for charging EVs is not efficient. An EV charging station powered by renewable energy (RE) has significant potential for EV charging. A solar-powered charging station and a BESS (Battery Energy Storage System) are essential in the present situation. It is also recommended to provide additional grid support to ensure uninterrupted power supply to the charging station without overloading the grid. The ANFIS-based MPPT monitors the solar PV array's maximum power. Generate the power and charge the EV battery and Stationary battery storage system from the PV source and also transfer power to the grid. When the PV array does not generate power and no power in the stationary battery storage system then the Grid charges the stationary battery storage system and the EV battery. The findings of the present research can also help to increase power efficiency and the power factor should be maintained.

Key Words: PV source, BES Grid, EV Station, Bi-directional converter, ANFIS, PID,

1. Introduction:-

In current times transportation systems based on non-renewable sources are the key factor in the increase in global warming. This will be overcome by the use of renewable energy-based transportation systems. Solar power has been used for at least 20-25 years. Solar energy is now the RE source with the quickest rate of growth, and as the globe moves toward more clean, sustainable energy sources, its popularity is expected to only increase. The utilization of solar energy is expected to increase and become more crucial in supplying the world's energy needs. Furthermore, solar energy can be used to power remote or underdeveloped areas, providing access to electricity and enhancing the quality of life for people in those areas. In some cases, solar energy can also provide a more reliable source of electricity than traditional grid systems, which may be prone to blackouts and outages. The efficiency and financial viability of solar energy are

projected to rise more as technology develops. A solar PV system that is grid-connected and has the ability to feed power into and take power from the grid in both directions. This type of system is becoming increasingly popular as people are looking for ways to move towards renewable energy and reduce their dependence on fossil fuels.

One of the challenges with a bi-directional grid-connected solar PV system is ensuring that it operates efficiently and effectively. To address this challenge, researchers have been exploring the use of artificial intelligence (AI) approaches, such as ANFIS and neural networks, to optimize system performance. ANFIS, or Adaptive Neuro-Fuzzy Inference System, is a type of AI that combines the strengths of fuzzy logic and neural networks to create a more powerful and accurate system.

2. Methodology

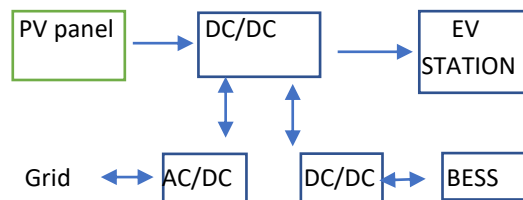

Fig.- ANFIS Bi-directional Grid Connected EV Charging Station with Battery Storage System

The first section is the generation section, where temperature and solar radiation are used by the PV array to produce power. The PV Array employs maximum power point tracking, or MPPT, to optimize the production of electricity. An inverter is employed to further convert the DC electricity produced by the PV system into AC power. The DC link voltage is used to feed supply power from the PV source to the EV charging station.

The stationary battery storage system is connected to the PV source and EV charging Station by the use of a DC-DC bidirectional converter. When extra power is generated by PV array or No vehicle is connected to the EV station it will be stored in a Stationary battery storage system. Which will provide the back source to the EV station when the PV array is OFF.

The PV source is directly connected to the EV charging station as well as the stationary battery. Grid-connected to the EV Charging Station with the DC link.

The stationary battery storage system, EV charging system, and PV source are all connected to the grid. To feed grid electricity to EVs and PV power to the grid.

The adaptive neuro-fuzzy interface system works the same as the Fuzzy interface system. Utilizing ANFIS, a perfect duplicate of the real solar PV system is created in this MPPT structure. A pair of inputs (temperature and irradiance) and one output (voltage) are employed to train ANFIS under various temperature and irradiance conditions.

A PWM (Pulse Width Modulation) generator for solar panels is a device that helps control the quantity of energy the solar panels are producing. The PWM generator works by controlling the amount of energy that is being transferred from the solar panels to the battery or grid, ensuring efficiency and safety. [4]

Buck-boost converter is a type of DC-DC converter that operates by converting DC voltage from a source at one level to a different level. It is a switch-mode power supply that can step up or down voltage levels depending on the input and output configurations.

Grid-connected photovoltaic (PV) power systems frequently employ PLL (Phase-Locked Loop) to synchronize the PV system's output with the grid's frequency and phase. In a grid-connected PV system, an inverter is employed to convert the DC power generated by the PV panels into AC electricity. To be fed into the grid, the AC power must be in phase and frequency alignment with the grid. The PLL system modifies the frequency and phase of the inverter to match the grid after measuring the grid voltage's phase and frequency. The PLL system regulates the frequency and phase of the inverter via a feedback loop.

A PI controller is a type of feedback controller commonly used in engineering applications to regulate a system's behavior. A PI controller can be used in a solar PV EV charging station to modify the rate at which an electric vehicle's battery charges according to the quantity of solar energy that is available.

An LCL filter is a type of filter circuit that is often used in power electronics applications to reduce harmonic distortion in the output of an inverter. The filter consists of an inductor (L), capacitor (C), and inductor (L) connected in series between the output of the inverter and the load. The purpose of the LCL filter is to minimize the high-frequency elements present in the inverter's output voltage waveform.

2.1 An adaptive neuro-fuzzy inference system (ANFIS)

ANFIS is a network that emulates the behavior of both neural networks and fuzzy inference systems (FIS). The adaptive neural network lacks synaptic weights but contains both adaptive as well as non-adaptive nodes. The adaptable network receives its name since it is essentially transformed into a standard feed-forward neural network structure. [6]

The emulator of the adaptive Takagi-Sugeno fuzzy controller shares a structure with the ANFIS adaptive network. This adaptable network functions in a manner that is comparable to a FI (Flexible Interface). The ANFIS network utilizes gradient descent as well as least squares to adjust the input and output parameters for the specified input/output data set during the back-propagation process. The input as well as output parameters of the ANFIS network are the terms employed to describe its linear and nonlinear properties, respectively. The predecessor and successor segments make up the ANFIS network's 2 primary parts. Both a FIS and a rule-based system link these components.

➤ Layer 1:

This layer's Node I is referred to as an adaptive node, and its parameters are the ANFIS network's nonlinear parameters. Equation (2) states that each node's function is,

$$L_{1,I} = \mu A_i(e) \dots \dots \dots (1)$$

$$L_{1,I} = \mu B_i(\Delta e) \dots \dots \dots (2)$$

where e and Δe denote the inputs of layer 1 node i . Each node's membership functions are A_i and B_i . The input variables are typically distributed using a Gaussian membership function, which assigns each node its membership function. As a consequence of Equation (3), the function of Gaussian membership is represented as follows.

$$f(x; \sigma, c) = \frac{-(x-c)^2}{2\sigma^2} \dots \dots \dots (3)$$

where the breadth and center of the Gaussian membership function are, respectively, σ and c . The center and width parameters are nonlinear characteristics that change as the learning procedure progresses.

➤ Layer 2:

An output node that is fixed and represented by the symbol " Π "; its signals are the product of Layer 1 node signals. The node function is represented, in Eq. (4)

$$L_{I,K} = W_i = \mu A_i(e) \mu B_i(\Delta e) \dots \dots \dots (4)$$

"The output of each layer 2 node determines the rule base's firing strength"

➤ **Layer 3:**

The letter "N" stands for this layer node, which is also known as a fixed node. The output is generated by calculating the ratio of each node's value to the total value of all the nodes. The node function is represented by the equation (5).

$$L_{3,i} = W_i = \frac{w_i}{\sum_{i=1}^j w_i} \dots\dots\dots(5)$$

➤ **Layer 4:**

This node is adaptable. The functioning of this node is expressed as, in Eq. (6)

$$L_{4,i} = \overline{W}_i f_i = \overline{W}_i (p_i e + q_i \Delta e + r_i) \dots\dots\dots(6)$$

Where \overline{W}_i is the normalized layer 3 firing strength and are the ANFIS network's linear parameters, also known as network consequent parameters. During the learning phase, these parameters are adjusted using the least-squares method.

➤ **Layer 5:**

The output layer is a fixed node found in this layer, which is denoted by the symbol " Σ ". The weighted average approach is used to determine the output from this layer, which is given by equation (7).

$$L_{5,i} = \sum_{i=1}^j \overline{W}_i f_i \dots\dots\dots(7)$$

A hybrid approach has been employed to update the linear and nonlinear parameters of Layers 2 and 4. ANFIS Parameters hybrid algorithm is a framework that combines least-squares and steepest descent techniques. The hybrid approach uses two different types of propagation: backward and forward. The hybrid algorithm's forwarding propagation carries the nodes' output up to Layer 4, where the least-squares approach is employed to modify the linear parameters. The false signals traveled backward during the hybrid approach's backward propagation, and gradient descent changed the nonlinear parameters. The hybrid approach converges more rapidly than usual back-propagation algorithms due to the significant reduction in search dimensions during training.

Input-Layer Layer 1 Layer 2 Layer 3 Layer 4 Layer 5

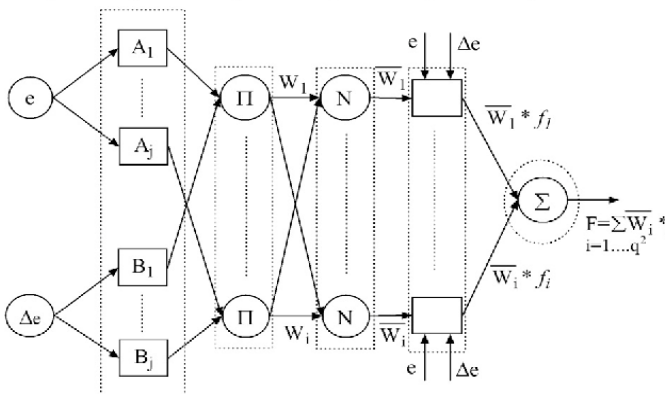

Figure 2.1:- Five Layer ANFIS Structure

2.2 MPPT with an ANFIS system-PI controller

In this MPPT structure, an exact replica of the original solar PV system is modeled utilizing ANFIS. ANFIS is trained using two inputs (temperature and irradiance) and one output (voltage) under a range of temperature and irradiance situations. The error voltage is generated by collecting the voltage reference from the output of the ANFIS system and comparing it with the real PV voltage. The duty cycle for the PWM generator is generated by the proportional-integral controller, which also processes the error voltage. [8]

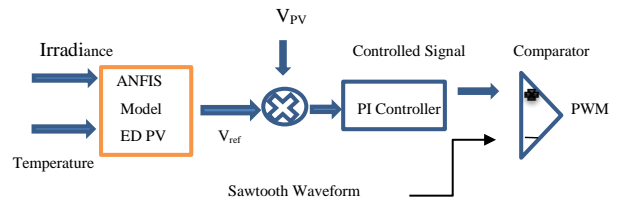

Figure 2.2 ANFIS Voltage Controlled MPPT

2.3 PLL (Phase Locked Loop)

In grid-connected PV power systems, phase-locked loops, or PLLs, are frequently employed to synchronize the PV system's output with the grid's phase and frequency. In a grid-connected PV system, the DC power produced by the PV panels is transformed into AC electricity through the utilization of an inverter. To be fed into the grid, the AC power must be in phase and frequency alignment with the grid. The PLL mechanism modifies the frequency and phase of the inverter to match the grid after figuring out the grid voltage's phase and frequency. The PLL system regulates the frequency and phase of the inverter via a feedback loop.

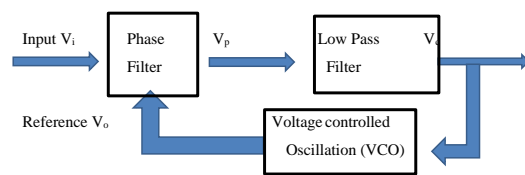

Fig 2.3 PLL (Phase Locked Loop)

2.4 PWM Generator

A PWM (Pulse Width Modulation) generator for solar panels is a device that helps regulate how much energy the solar panels are producing. The PWM generator works by controlling the amount of energy that is being transferred from the solar panels to the battery or grid, ensuring efficiency and safety. [4]

2.5 Battery Storage System

A battery storage system is a technology that allows solar power generated by photovoltaic (PV) panels to be stored for later use. When energy demand exceeds the quantity of energy supplied by the PV panels or when the sun isn't

shining, battery storage systems employ the DC power from the PV panels to create AC power, which is then stored in batteries for later use[20]

Results:-

➤ **1st Mode:**

EV battery charging with PV array alone. Currently, the temperature remains consistent, the intensity of the PV panel is modified, and the ANFIS voltage-controlled method is utilized for collecting electricity from the PV array.

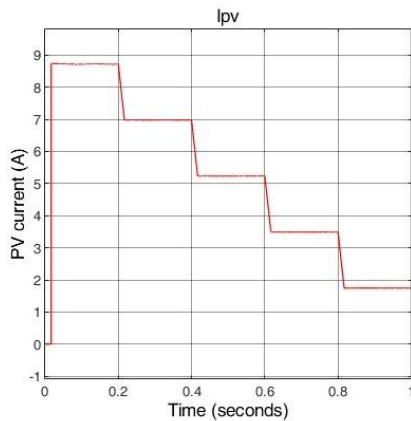

➤ **2nd Mode:**

Only when the BESS is connected to a DC bus can solar energy be employed to charge EV batteries and the BESS itself. PV panel operating using ANFIS at MPPT.

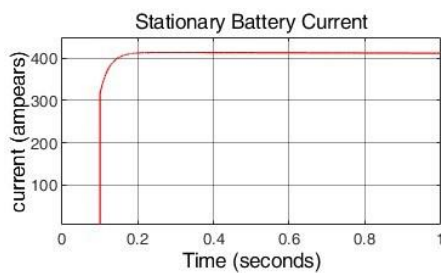

➤ **3rd Mode:**

EV batteries are charged with a combination of BESS and solar electricity under varying irradiance conditions. ANFIS guarantees the maximum power that can be obtained from the PV array.

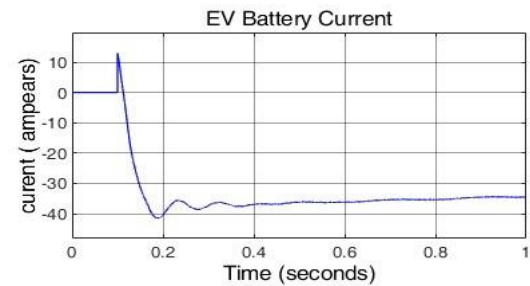
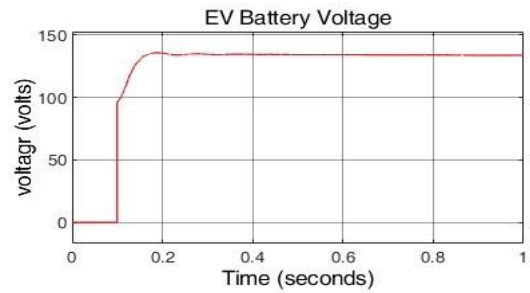

➤ **4th Mode:**

When the PV array is not producing solar radiation at night, the BESS and AC grid are utilized to charge the EV battery. The AC grid's power flow is managed by a functional fitting neural network.

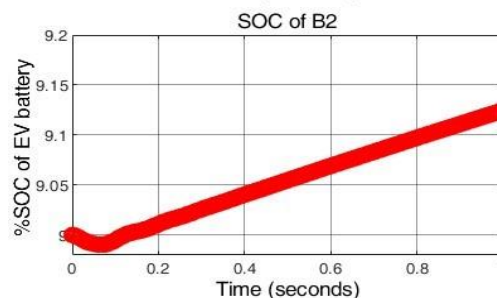
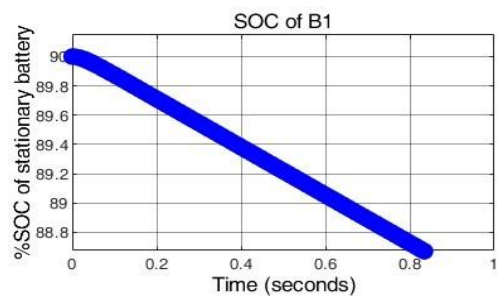

➤ **5th Mode:**

The temperature and irradiance of the PV array are regulated. Extra power is fed into the grid and used to charge EV batteries when a solar PV array, BESS, and AC grid are linked.

3. CONCLUSIONS

An ANFIS Bi-directional Grid Connected EV Charging station with a Battery Storage System is an elegant way of

combining Solar PV, GRID, as well as Battery energy systems for charging EVs in EV stations. This will reduce carbon emission also maximize the use of renewable energy. Which will lead to reduced global warming. Also, minimizes the dependency on conventional resources and the grid to charge the electric vehicle.

REFERENCES

- [1] Jlidi, M., Hamidi, F., Barambones, O., Abbassi, R., Jerbi, H., Aoun, M., & Karami-Mollae, A. (2023). An Artificial Neural Network for Solar Energy Prediction and Control Using Jaya-SMC. *Electronics*, 12(3), 592. 10.3390/electronics12030592
- [2] Alrubaie, A. J., Salem, M., Yahya, K., Mohamed, M., & Kamarol, M. (2023). A comprehensive review of electric vehicle charging stations with solar photovoltaic systems considering market, technical requirements, network implications, and future challenges. *Sustainability*, 15(10), 8122. 10.3390/su15108122
- [3] Wang, H., Pourmousavi, S. A., Soong, W. L., Zhang, X., & Ertugrul, N. (2023). Battery and energy management system for vanadium redox flow battery: A critical review and recommendations. *Journal of Energy Storage*, 58, 106384. 10.1016/j.est.2022.106384
- [4] Colasante, A., D'Adamo, I., & Morone, P. (2022). "The effect of policies, incentives, and behavior in a cross-country comparison. *Energy Research & Social Science*", 85, 102405., ISSN 2214-6296. 10.1016/j.erss.2021.102405.
- [5] Islam, N., Nat, A., & Khan, R. A. (2022). Recent Technological Advances in Solar Photovoltaic Systems and Its Applications in Building Integrated Photovoltaic Systems. *Sustainable Technology and Advanced Computing in Electrical Engineering: Proceedings of ICSTACE 2021*, 625-636. 10.1007/978-981-19-4364-5_45
- [6] Malik, P., Gehlot, A., Singh, R., Gupta, L. R., & Thakur, A. K. (2022). A review of ANN-based model for solar radiation and wind speed prediction with real-time data. *Archives of Computational Methods in Engineering*, 1-19. 10.1007/s11831-021-09687-3
- [7] Waqas Khan, Shalika Walker, Wim Zeiler, (2022) "Improved solar photovoltaic energy generation forecast using deep learning-based ensemble stacking approach." *Energy*, Volume 240, 2022, 122812, ISSN 0360-5442, 10.1016/j.energy.2021.122812
- [8] Rohit Trivedi, Shafi Khdem. (2022) "Implementation of artificial intelligence techniques in microgrid control environment: Current progress and future scopes." *Energy and AI*, Volume 8, 2022, 100147, ISSN 2666-5468. 10.1016/j.egyai.2022.100147.
- [9] Kang Miao Tan, Thanikanti Sudhakar Babu, Vigna K. Ramachandaramurthy, Padmanathan Kasinathan, Sunil G. Solanki, Shangari K. Raveendran, (2021) "Empowering smart grid: A comprehensive review of energy storage technology and application with renewable energy integration." *Journal of Energy Storage*, Volume 39, 2021, 102591, ISSN 2352152X, 10.1016/j.est.2021.102591.
- [10] Kumar, Astitva & Rizwan, M. & Nangia, Uma. (2021) "Development of ANFIS-based algorithm for MPPT controller for standalone photovoltaic system." *International Journal of Advanced Intelligence Paradigms*. 18. 247. 10.1504/IJAIP.2021.112906.
- [11] Bendary, A.F. Abdelaziz, A.Y. Ismail, M.M. Mahmoud, K. Lehtonen, M. Darwish, M.M.F. (2021) Proposed ANFIS Based Approach for Fault Tracking, Detection, Clearing and Rearrangement for Photovoltaic System. *Sensors* 2021, 21,2269, 10.3390/s21072269.
- [12] Singh, A. Shaha, S.S., G, N.P. Sekhar, Y.R. Saboor, S., Ghosh, A., (2021) "Design and Analysis of a Solar-Powered Electric Vehicle Charging Station for Indian Cities". *World Electr. Veh. J.* 2021, 12, 132. 10.3390/wevj12030132.
- [13] Ahmad, Furkan & Khalid, Mohd & Panigrahi, Bijaya. (2021) "An enhanced approach to optimally place the solar-powered electric vehicle charging station in a distribution network." *The Journal of Energy Storage*. 42. 103090. 10.1016/j.est.2021.103090.
- [14] G. Liu, Y. Xue, M. S. Chinthavali and K. Tomsovic, (2020)"Optimal Sizing of PV and Energy Storage in an Electric Vehicle Extreme Fast Charging Station," 2020 IEEE Power & Energy Society Innovative Smart Grid Technologies Conference (ISGT), Washington, DC, USA, 2020, pp. 1-5, 10.1109/ISGT45199.2020.9087792.
- [15] Li, Baojie & Delpha, Claude & Diallo, Demba & Migan-Dubois, A, (2020). "Application of Artificial Neural Networks to photovoltaic fault detection and diagnosis." A review. *Renewable and Sustainable Energy Reviews*. 138. 110512. 10.1016/j.rser.2020.110512.
- [16] Nwaigwe, Kevin & Mutabilwa, Philemon & Dintwa, Edward. (2019) "An overview of Solar Power (PV Systems) Integration into Electricity Grids." *Materials Science for Energy Technologies*. 2.10.1016/j.mset.2019.07.002.
- [17] Unal Yilmaz, Omer Turksoy, Ahmet Teke, (2019) "Improved MPPT method to increase accuracy and speed in photovoltaic systems under variable atmospheric conditions" *International Journal of Electrical Power & Energy Systems*, Volume 113,2019, Pages 634- 651, ISSN 0142-0615, 10.1016/j.ijepes.2019.05.074.

[18] Khan, and I. U., (2019) "Comparative analysis of MPPT techniques using ANFIS for grid-connected solar PV system". *Journal of Electrical Engineering & Technology*, 14(5),2500-2513.

[19] Dai, Q. Liu, J. Wei, Q.(2019). "Optimal Photovoltaic/Battery Energy Storage/Electric Vehicle Charging Station Design Based on Multi-Agent Particle Swarm Optimization Algorithm". *Sustainability* 2019, 11, 1973. 10.3390/su11071973.

[20] Krewer, Ulrike, Röder, Fridolin, Harinath, Eranda, Braatz, Richard, Bedürftig, Benjamin, Findeisen, Rolf, (2018) "Review-Dynamic Models of Li-Ion Batteries for Diagnosis and Operation: A Review and Perspective. *Journal of The Electrochemical Society*." 165. A3656-A3673. 10.1149/2.1061814jes.

[21] Raugei, Marco & Sgouridis (2017) "Energy Return on Energy Invested (EROEI) for photovoltaic solar systems in regions of moderate insulation." A comprehensive response. *Energy Policy*. Volume 102. 377-384. 10.1016/j.enpol.2016.12.042.

[22] Bruno Scrosati, Jürgen Garche, (2010). "Lithium batteries: Status, prospects and future." *Journal of Power Sources*, Volume 195, Issue 9, 2010, Pages 2419-2430, ISSN 0378-7753. 10.1016/j.jpowsour.2009.11.048