

A review paper on Optimization of cast iron casting for defect minimization by using Simulation and Analytical techniques

Mr. Vagesh Ramanbhai Nai¹, Dr. Vineet Kumar Goel², Mr. Dharmang Patel³, Mr Kaushal Rajkishor Shukla⁴

¹ Research scholar of Bhagwan Mahavir college of engineering and technology

²Dean of engineering, Bhagwan Mahavir university

³HoD of mechanical engineering of Bhagwan Mahavir college of engineering and technology

⁴ Research scholar of AH TECHNOCAST PVT LTD

Abstract - Nowadays manufacturing sector has entered a new era. Conventional and manual manufacturing system is replaced by modern manufacturing technology. Sand casting processes like green sand casting in general involve a large number of parameters that affect the various casting quality features of products. Some parameters are controllable and others are uncontrollable, they are essential responsible for variation in casting quality.

In this research work present the design of experiment based approach which is adopted to obtain an optimal setting of moisture content, grain particle size and temperature of pouring metal related parameters of green sand casting in A.H TECHNOCAST PVT LTD at PIPODARA, SURAT. The casting parameters identified for green sand casting process are moisture content, green strength, mould hardness, permeability, sand particle size, pouring temperature ramming pressure, cooling time.

For defect analysis, the possible causes are grouped into design, material and process parameters. The effect of suspected cause parameters on casting quality is ascertained through simulation. Based on the results and their interpretation, the optimal values of the parameters are determined to eliminate the defects. Simulation tool to be use to introduce new gating system of cast iron housing to improve its quality and yield. computer programs have been invented to enable designers to take control over liquid metal behavior and help to eliminate defective part, especially porosity defects inside the casts.

Key Words: Casting defects minimization, Casting Simulation Process, casting defect, casting defect analytical technique.

1. INTRODUCTION

1.1 SAND CASTING [13]

Casting is one of the oldest manufacturing process dates back to 4000 B.C. when copper arrowheads were made. Casting produced by foundry as per customers' specifications, their quality level otherwise the casting is term as defective. If casting is defective then it is

rejected. Rejected parts contributed to the wastage and loss of value to the foundry. For improve the cast metal yield, we need to optimize the gating system design, optimize mould filling, avoid shrinkage defects, voids, hot tears etc. casting simulation tools to very helpful to achieve above objectives. With advent of modern computing facilities, application of commercial software's, packages such as casting simulation tools, enable the foundry industries to accomplish successful casting design.

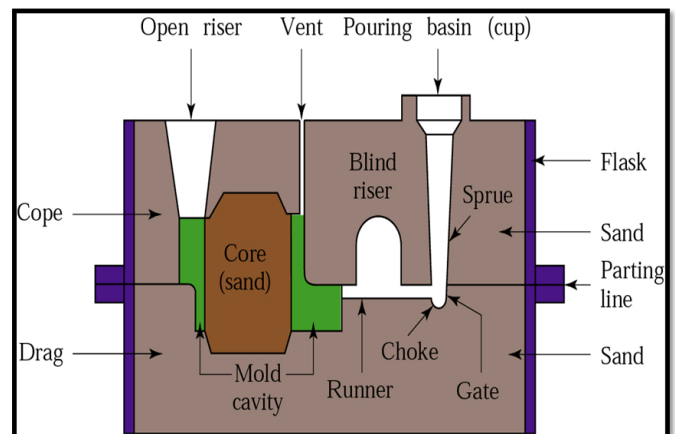

2. LITERATURE REVIEW

UdayA.Dabade *et al*^[1] combination of design of experiment and casting simulation technique to analysis the sand and methodology defects in green sand casting. In first session, using Taguchi based orthogonal array use to purpose of experiment and analysis of variance (ANOVA) indicates in selected parameter and percentage of rejection. In second session shrinkage porosity analysis by using simulation technique using new gating system designed. Result indicates new gating system and feeder reduction in porosity about 15% and yield improvement 5%.

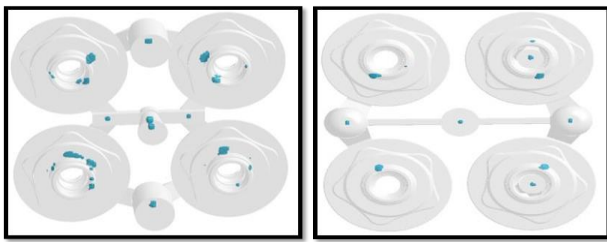

Figure: 2.1 a) Shrinkage porosity b) Shrinkage porosity with new gating design.

Sunanda & Raju (2021) [3] Casting is the method by which different kinds of metal products are manufactured. Sand casting is one of the commonly utilized metal casting processes because of its inherent benefit of the production, low cost, and high production rate. The critical issue with the sand casting process is casting defects and unstable casting quality. The pulley's quality characteristics have been affected by casting defects, which leads to a large number of shop floor trails, a high rejection rate, and poor casting performance. Knowledge of casting defects and causes is essential for quality control. Various researchers have stated that 90% of casting defects are accumulated only because of the deficient design of the gating and feeding systems. In this work, creo software was used to create the Solid model of a pulley and the gating system. Using Procast Simulation software, mold filling, and solidification analysis was performed. Medium carbon steel was chosen for its wide variety of automotive applications. The Sand mold was chosen as a mold material, and prediction analysis has been implemented using computer-aided simulation software [2]

Mohan & et al. (2020) [2] In this current scenario of globalization, foundries play a key role for manufacturing industries as they are the major source of castings. Casting has various processes like Pre casting Processes, pattern making, core making, moulding and mould assembly making, Casting Processes, furnace charging, melting, holding and pouring, and Post casting Processes, shakeout, inspection and dispatch etc. In India there are many foundry have followed conventional and manual operations. Today's competitive environment has, lower manufacturing cost, more productivity in less time, high quality product, defect free operation are required to follow to every foundry man. Mould shifting, Crushing, Lower Surface finish, Shrinkage, Porosity, Cold shut and Extra material are common casting defects due to these manual operations. These defects directly affect on productivity, profitability and quality level of organization.

Manu khare et al [3] analysis of significant parameter of green sand casting of fly wheel which is FG350 alloy [FG 260]. He take parameters are green strength, clay content and pouring time. Result indicates that green strength is significant parameter while clay content and pouring temperature are non-significant parameter.

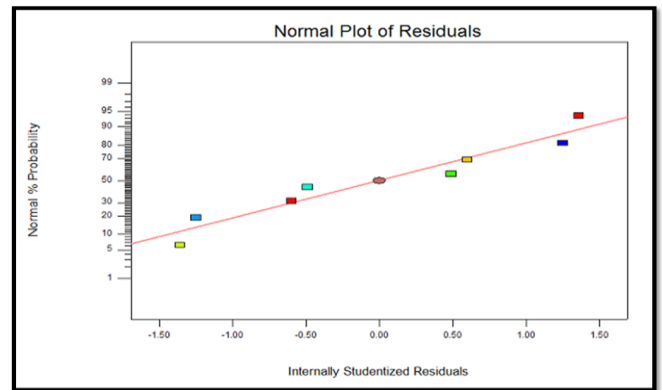

Figure: 2.2 Normal Probability plot of Residuals for Percentage.

Rasik a. Upadhya et al [4] to optimized sand casting process parameter of the casting manufactured iron foundry by maximized the s/n ratio (signal to noise ratio). Also minimized the noise factors by Taguchi Method. Taken process parameters are moisture, sand particle size, green compression strength, mould hardness, permeability, pouting temperature, pouring time and pressure test. Result show the process parameters are affected on casting defects in iron foundry. Improvement in reduction in casting defects is to be 37.66 %.

Table 2.1 Optimum Condition and Performance.

	FACTORS	LEVEL DESCRIPTION	LEVEL	CONTRIBUTION
1	Moisture %	3.5	1	0.987
2	GCS g/cm ²	900	1	1.574
3	Permeability	185	2	0.508
4	Pouring Temperature	1420	3	0.856
5	Total contribution from all factors current grand average of performance expected result at optimum condition improvement expected			3.924 -15.544 -11.619 37.66%

C.M. Choudhary et al [5] found the major role of shrinkage porosity in the rejection of components in foundry. Take LM6 casting material and doing experiment work and seen the defect of shrinkage porosity and when solidification completed, the last region of solidify hot spot are there. So using methoding and simulation technique, feeding aids help to us to gating the hot spot completely shifted in feeder. Simulation technique help the in improvement in yield and quality of casting component.

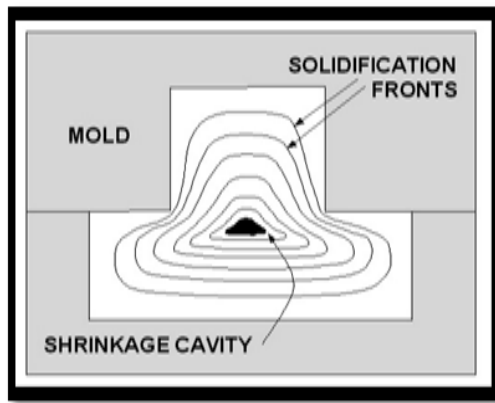

Figure: 2.3 Typical Solidification Process



Figure: 2.4 Casting Solidification Simulation

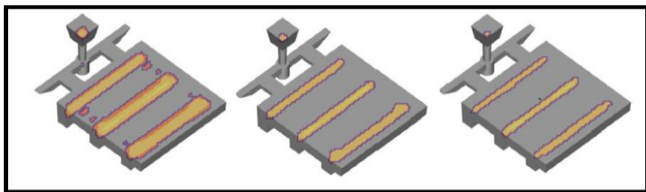

Figure: 2.5 Progressive Convergences of Hotspots Indicates Last Solidify Region.

Y Chang *et al*^[6] investigation the properties of green moulding sand and new model evolves the Flow ability of sand compact is developed. In Sand Casting process very importance to controlling the Flow ability of Moulding sand. Study about the experiment results are indicates to show how flowability of silica sand is affected by water content, Bentonite and sea-coal content. The existing flowability indicates such as compatibility slop of stress-strain curve, hardness gradient, can not totally agree with experiment results

A. Rai *et al*^[7] for foundry industries very important issues to control of defects of sand casting process. Casting defects Diagnosis and analysis by multiple events like melt-preparation, mould core preparation, pouring, solidification and fettling. Knowledge-based expert system been used to supported to decision making for process. The expert system should capable to identification of defects and its diagnosis and help to us designer and production engineer to decided decision making regarding to reduction in defects of casting.

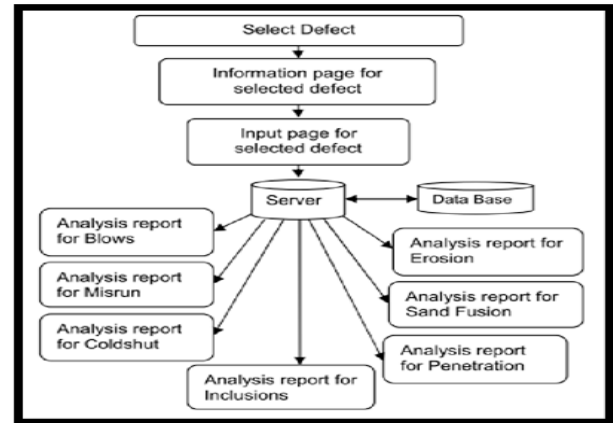

Figure: 2.6 Frame-work of defects analysis system

Raghwendra *et al*^[8] because of relation between the casting defects and green sand properties, traditional method trial and error based on know and experiment have many disadvantages like consuming of time, non-symmetrical and its needed very long time for experiment doing.

Traditional method is replaced by ANN (artificial neural network) and data mining tools for preventing the above disadvantages. So effects of riser design, gating system, molding sand, oxidation and deformation of casting during heat treatment, machining allowance economical review. To optimized process parameter significantly improvement in yield, output ratio of metal, shorten manufacturing period, save energy, less pollution and improve in competitive with enterprise.

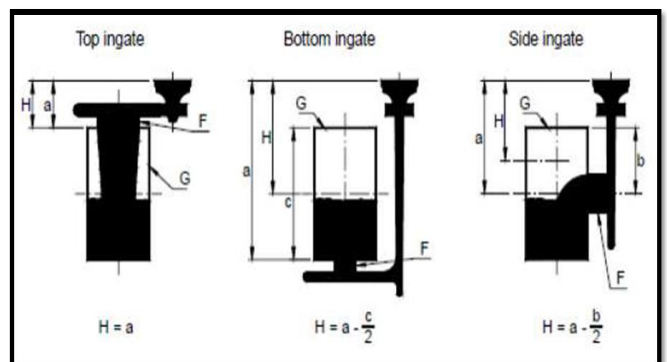

Figure: 2.7 Average Metallostatic Heights H in Three Type of Ingate System

P.Prabhakara rao *et al*^[9] in cement industries for crushing component and load bearing structure, to achieved quality requirement of superior mechanical properties. So Using CAD technologies combined with process simulation tools are used to optimized filling and solidification of cast part. Here discussed new developed simulation tools and its application to crusher component. Result show that casting trails are high level confidence in simulation tools.

By using simulation tools, it is help to foundries to reduced scrap and also minimized defects. Simulation tool used to identify critical area, filling pattern and solidification related problems area in casting. As simulation tool used PRO-CAST.

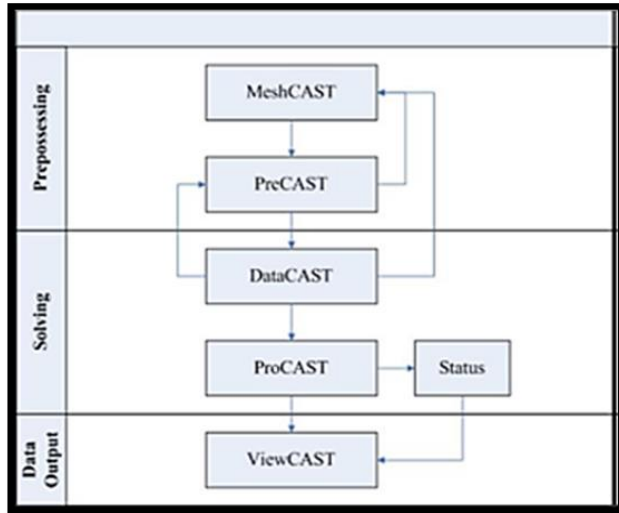

Figure: 2.8 Pro-cast Working Flow

2.1 Outcome from Literature Review

- After studies some research papers of based on minimized casting defects, D.E.O.{design of experiment} methods like TAGUCHI, ANOVA, ANN , Response surface method (RSM) are very effectiveness to optimized process parameters of casting.
- Also simulation tools are like pro-CAST, auto-CAST, magma, etc.. Very useful to new design of gating system and know the how much reduced defects. Also improved in quality of cast component and in yield

REFERENCES

[1]Uday A. Dabade *et al*, “Casting defects analysis using design of experiment and computer aided simulation technique”, Forty-sixth CIRP Conference on Manufacturing System 2013.

[2] N.S.Mohan-“Analyzing the casting defects in small scale casting industry” International Conference on Newer Trends and Innovation in Mechanical Engineering: Materials Science. Material Todays ProcessdingsVolume 37, Part 2, Pageno. 386-394, 2021.

[3] A.sunanda -“ Simulation for prediction analysis of defects in pulley casted using sand casting process”. Material Todays Processdings Emerging Trends in Materials Science,Technology and Engineering. March 2021

[4]Rashik Upadhya, Dr.Ishwar P Keswani “optimization of sand casting process parameters using taguchi method” International Journal of Engineering Research & Technology (IJERT), ISSN No. 2278-0181., Vol.1, September-2012.

[5] C.M.Choudhary *et al*, “methodology and simulation of LM6 sand casting for defects minimization with its experimental validation” 12TH Global Congress on Manufacturing and Management, GCMM2014.

[6] Y.Chang *et al*, “The flow ability of bentonite green mould sand” Journal Of Materials Processing Technology 113(2001) 238-244.

[7] A Rai *et al*, “Web based expert system for some defects sand casting” International Journal of Advanced Engineering Research And Studies E-ISSN 2249-8974

[8] Raghwendra *et al*, “optimization in green sand casting process for effeciant, economical and quality casting” International Journal of Advanced Engineering and Technology E-ISSN 0976-3945.

[9] S.GUHARAJA PHD Thesis, “Optimization of casting process parameters using TAGUCHI method and evolutionary heuristics” Anna University, Chennai-Feb-2009.

[10] A.H Technocast Pvt Ltd.

[11] Vishal S. Jadhao , Prof. J.J.Salunke “Review Paper on Simulation Based Casting” International Journal of Innovative Research in Science, Engineering and Technology.

[12] Mr. Rohan D. Ahirrao “ A REVIEW PAPER ON ANALYSIS AND OPTIMIZATION OF ALUMINIUM CASTING PARAMETERS” International Research Journal of Engineering and Technology (IRJET)”

[13] Anil B Ghubade “Review on casting defects and methodologies for quality improvement” JETIR April 2019, Volume 6, Issue 4