

Conceptual Design, Structural Analysis and Fabrication of a Smart Phone Operated Multipurpose Agribot

Kamal Ahmed¹, Mohammed Noorullah Khan², Mohd AdeeB Hussain³

¹Assistant Professor, Department Mechanical Engineering, Vijay Rural Engineering College, Nizamabad, Telangana, India.

²Student, Department Mechanical Engineering, Vijay Rural Engineering College, Nizamabad, Telangana, India.

³Student, Department Mechanical Engineering, Vijay Rural Engineering College, Nizamabad, Telangana, India.

Abstract - This research is about frame and load calculation and dimensioning, of the AGRIBOT. For the determination of forces on the elements, models and drawings are to be made in CAD software like Catia and analysis by Ansys software. The quality mesh is prepared for a converged solution and the solver is set as an analysis package with high-optimizing results. The resultant calculation parameter can be used for modelling the geometry and fabrication of the prototype.

Key Words: Agribot, Robotics, Agriculture Robot, Seed Sowing Machine.

1. INTRODUCTION

An agricultural robot (Agribot) is a robot designed for agricultural purposes. The main area of application of robots in agriculture is at the harvesting stage. Fruit-picking robots, driverless tractors/sprayers, and sheep-shearing robots are designed to replace human labour. The agricultural industry is behind other complementary industries in using robots because the sort of jobs involved in agriculture are not straightforward, and many repetitive tasks are not the same every time.

In most cases, a lot of factors have to be considered (e.g., the size and color of the fruit to be picked) before the commencement of a task. Robots can be used for other horticultural tasks such as weeding, pruning, spraying and monitoring. Robots can also be used in livestock applications (livestock robotics) such as washing, milking and castrating.

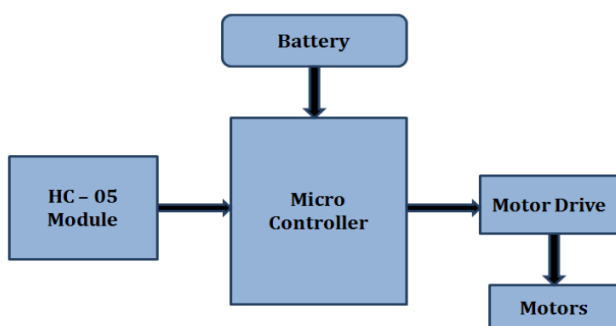

Fig. 1: Block Diagram Of The Research

1.1. Problem Statement

- Design an Agricultural Robot using a numerical approach (Mechanical constraints)
- Proper analysis is necessary to develop a mechanism for the robot. (Environment constraints)

1.2. Objective of the Research

- A system designed to record and report within a process.
- In this project we do design using Catia and Analysis is done using Ansys for the components of the project.
- In our project we track the robot by using wireless communication.
- Using microcontroller which is Programmable IC.

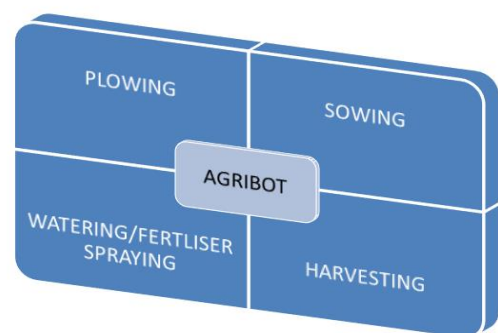

Fig. 2: Application of Agribot solution in agriculture

2. LITERATURE REVIEW

[1]. Jones, et al: "Vision-based Guidance for a Robot Tractor", this paper explores the improvement of vision-based guidance systems tailored for use in agricultural purpose, specifically focusing on their implementation in robot tractors.

[2]. **Zhang, et al:** "Agricultural Robotics: A Review", this paper explores comprehensive review of the landscape of agricultural robot, covering various types of robots and their applications within the agricultural purpose.

[3]. **Murad, et al:** "Automated Harvesting Systems: Recent Advances in Mechanized Harvesting of Crops", this paper explores advancements in automated harvesting systems, important components of agricultural robotics, focusing their importance in modern crop harvesting practices.

3. Material and Methods

The considerations made about the principles of the vehicle and the choices of concept for the mobile robot were: traction, steering, dimensions, frame, motors and power supply. The mechanical structure was designed by the studying of working conditions required in field and desired characteristics of the project, using the steps of processes described.

		thousands of discharge cycles. For this works eight batteries of 12 V and 70 Ah for traction, four batteries of 12V and 10 Ah for the steering system and one battery of 12V and 50 Ah for the computing system are used
--	--	--

4. MODELING OF AGRIBOT IN CATIA V5

Engineers and researchers work to increase the level of autonomous machinery in agriculture and the best solution is to design and build robots capable to work continuously without human guidance. Robots deployed for agricultural purposes can deliver high accuracy and low costs while the farmers can have in real-time a situation of tasks already completed.

This Agribot is designed using CATIA V5 software. This software is used in automobiles, aerospace, goods, heavy engineering etc. It is very powerful software for designing complicated 3d models, and applications of CATIA Version 5 like part design, and assembly design.

The same CATIA V5 R20 3d model and 2d drawing model are shown below for reference. Dimensions are taken from. The design of the 3D model is done in CATIA V5 software, and then to do the test we are using the below-mentioned software.

S,no	Component	Description
1	Frame	In order to reach this requirement, the frame format adopted was the portico one, with adjustable gauge which is light and flexible when compared with the commercial agricultural vehicles, with the possibility of inserting new sensors and actuators
2	Traction	In this Research, it was adopted a 4 wheels system and to increase the ability of vehicle to pull in adverse conditions, and independent traction in each wheel; primarily the system was dimensioned with full traction.
3	Steering	As for the choice of structure configuration and capability of adjustment of the gauge, a system that could be independent for each wheel, with easy construction and accuracy of steering was chosen, and therefore we opted for the system Ackerman geometry in front wheels.
4	Motors	The advantages of a brushed DC motor include low cost, high reliability, and simple control of motor speed. In this case, the DC motor which attends better the above demands can be used indoors and can be supplied by battery and power amplifiers, which makes it a flexible and easy solution to install
5	Power supply	They are designed to be fully discharged and recharged daily, can withstand

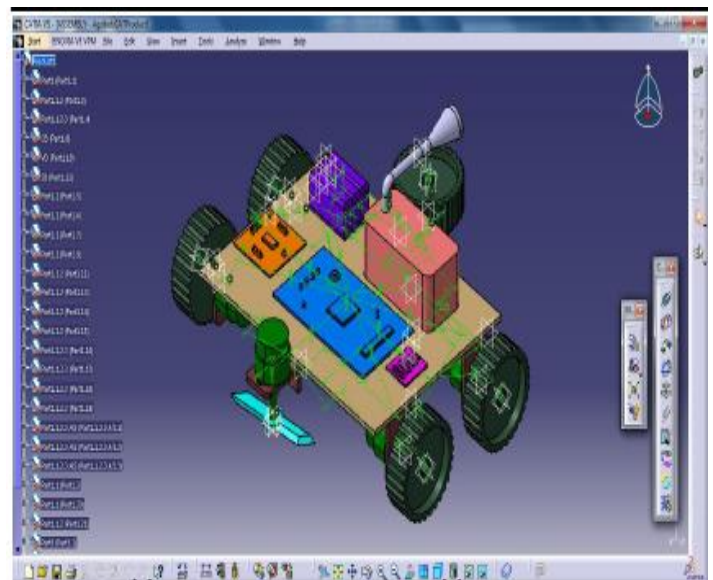

Fig. 3: Model Design Of Agribot In Catia-V5

5. ANALYSIS OF AGRIBOT IN ANSYS SOFTWARE.

After completing the designing of each component next is to do an analysis based on the OEM (Original Equipment of Manufacturer) application. So, all the models which are rotated along which axis we need to mention in the Analysis software to get accurate results as per the

original component. Some of the components need to be solved using static analysis

The analysis of the components is done using ANSYS. For complete assembly is not required, motor and attached system is to carried out by applying moments at the rotation location along which axis we need to mention.

5.1. Results of Displacement analysis of Frame, Wheel and Cutter:

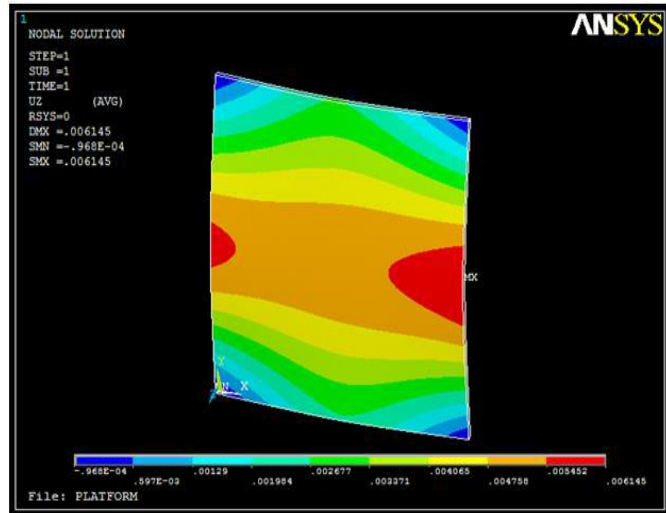

Fig. 4: Results of Displacement analysis

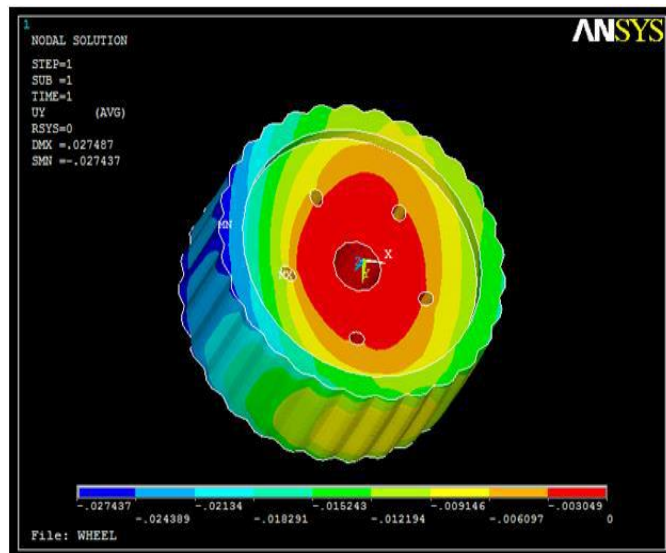

Fig. 5: Displacement of Wheel

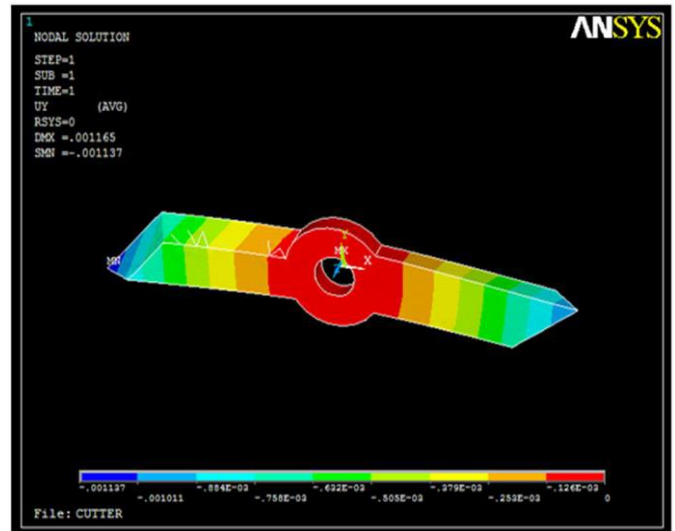

Fig. 6: Displacement of Cutter

5.2 Results of Stress analysis Frame, Wheel and Cutter:

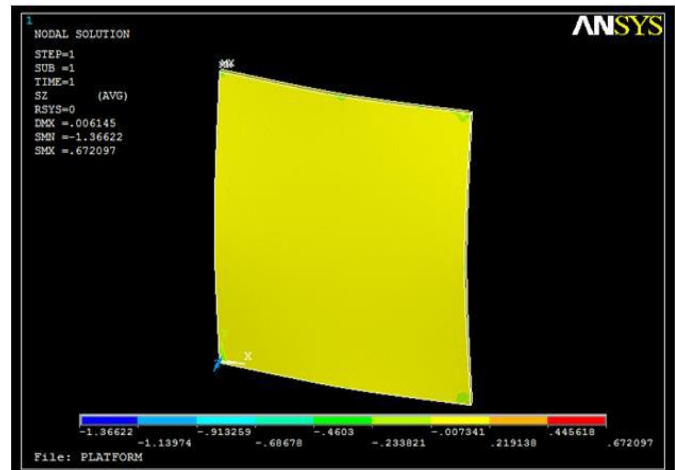

Fig. 7: Results of stress analysis

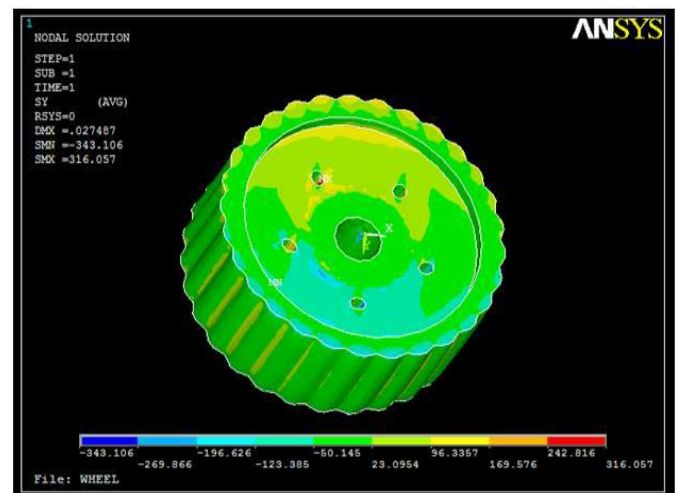

Fig. 8: Stress Analysis of Wheel

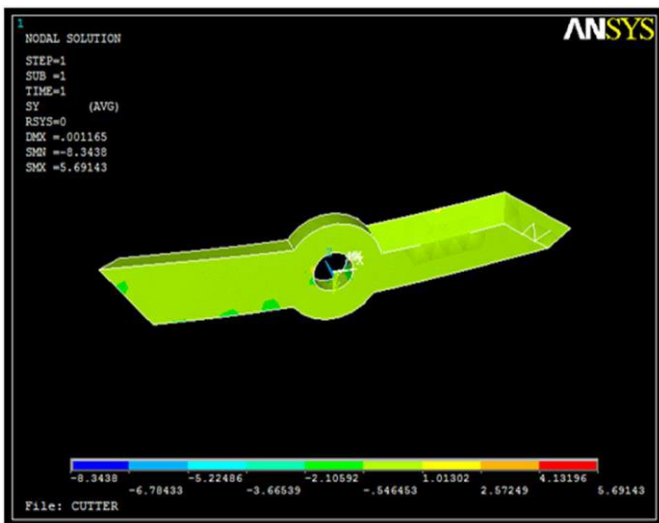

Fig. 9: Stress Analysis of Cutter

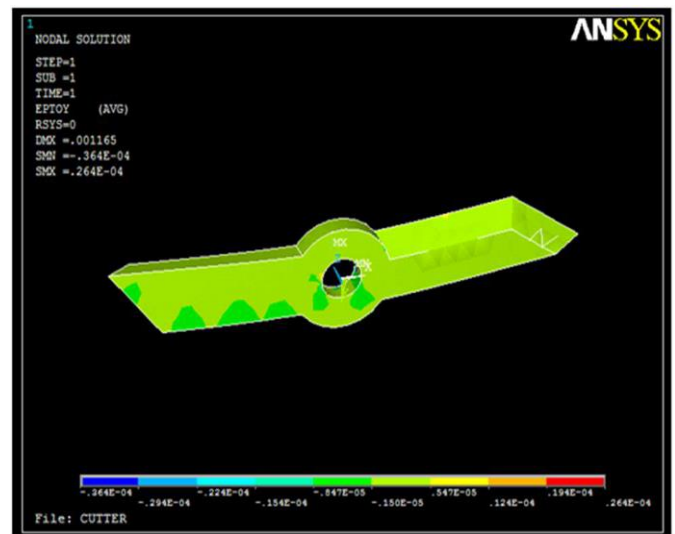

Fig. 12: Strain Analysis of Cutter

5.3 Results of stain analysis of Frame, Wheel and Cutter:

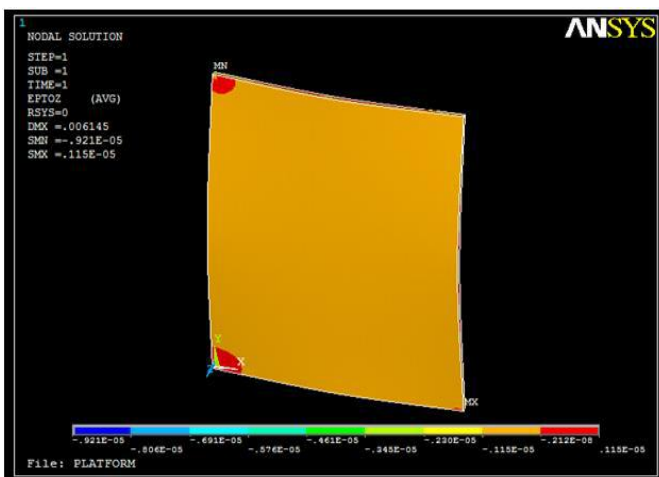

Fig. 10: Results of strain analysis

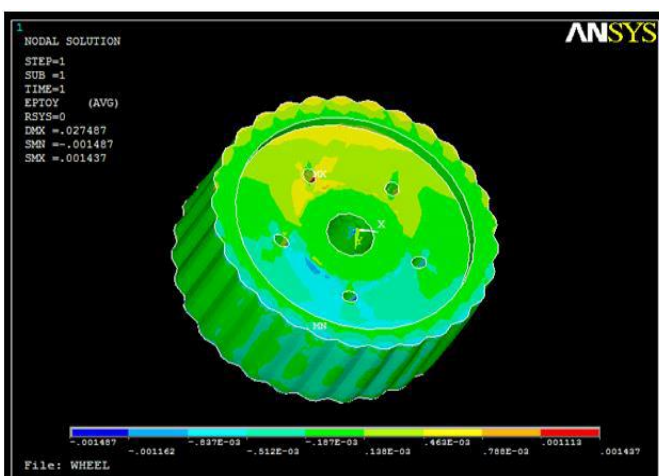

Fig. 11: Strain Analysis of Wheel

6.RESULT

As shown above figures, we are considering the Analysis results of Frame, Wheel and Cutter the of Agribot as it is the major working component in the project, so the displacement of the design is meshed and solved using Ansys and displacement, which is very less.

This shows us that each component in the robot assembly has minor displacement and the prototype is fabricated as per the design.

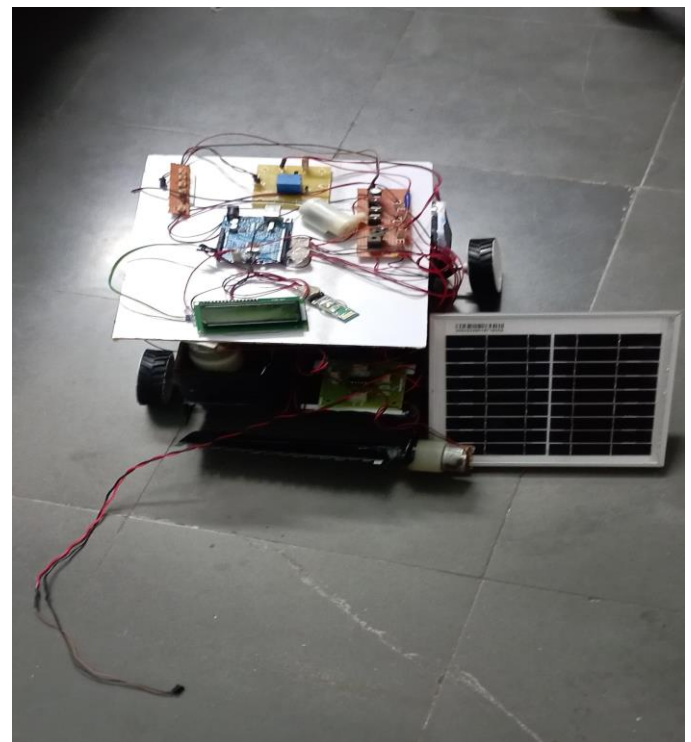

Fig. 13: Fabricated Model Of Agribot

7. CONCLUSIONS

This paper has set out a vision of how aspects of crop production could be automated in the future. Although existing manned operations can be efficient over large areas there is a potential for reducing the scale of treatments with autonomous machines that may result in even higher efficiencies.

Stress is at the fixing location (Minimum Stress which is acceptable), the value which is very less compared to yield value of Aluminum & Mild steel; this is below the yield point. The maximum strain, this solution solving with the help of Ansys software so that the maximum stress is less .so we can conclude our design parameters are approximately correct.



Mohd Adeb Hussain, Student, Dept. of Mechanical Engineering, VREC , Nizamabad, Telanagana, India

REFERENCES

- [1].Jones, C., & Meeussen, S. (2018). Design and analysis of an autonomous agricultural robot for variable-rate fertilization. *Computers and Electronics in Agriculture*, 145, 269-282.
- [2].Zhang, Q., & Huang, J. (2020). Design and Analysis of Agricultural Robot for Harvesting Sweet Pepper. *IEEE Access*, 8, 67847-67856.
- [3].Murad, M. A., Ahmed, S. H., & Haque, M. E. (2019). Design and fabrication of an agricultural robot for crop cultivation. In *2019 International Conference on Robotics, Electrical and Signal Processing Techniques (ICREST)* (pp. 182-186).IEEE.
- [4].Gu, Z., Cao, C., Zhao, S., & Wang, S. (2020). Design and Simulation Analysis ofAgricultural Robot Based on Virtual Prototyping Technology. In *Proceedings ofthe 3rd International Conference on Electronic Information Technology and Computer Engineering* (pp. 300-306). Atlantis Press.
- [5].Shen, H., Chen, X., Li, H., Sun, B., & Sun, M. (2021). Design and simulation of an automatic milking robot for dairy cows. *Journal of Physics: Conference Series*, 1790(1), 012025

BIOGRAPHIES



Kamal Ahmed, Assistant Professor, Dept. of Mechanical Engineering, VREC , Nizamabad, Telanagana, India



Mohammed Noorullah Khan, Student, Dept. of Mechanical Engineering, VREC , Nizamabad, Telanagana, India