

SMART FARMING USING IOT AND SOLAR ENERGY BASED MULTIPURPOSE AGRICULTURAL ROBOT

Rajendra M Tigadi¹, Raju B Gulli², Sachin S Babannavar³, Shivanand D Kabbur⁴
Prof. Gurudutt Ghadi⁵, Prof. Vishwanath M.K⁶, Dr. Rajendra M Galagali⁷

¹²³⁴Students, Department of Mechanical Engineering S.G. Balekundri Institute of Technology
Engineering Belgaum, Karnataka, India

⁵Professor and Project Guide, Department of Mechanical Engineering S.G. Balekundri Institute of Technology
Engineering Belgaum, Karnataka, India

⁶Professor and Project Coordinator, Department of Mechanical Engineering S.G. Balekundri Institute of
Technology
Engineering Belgaum, Karnataka, India

⁷Professor and HOD, Department of Mechanical Engineering S.G. Balekundri Institute of Technology
Engineering Belgaum, Karnataka, India

Abstract: As among the primary industries in India, agriculture is essential to the country's economy. In recent decades, Indian agriculture has experienced significant expansion. Even though a lot of work has been done in this subject, it is still highly important to find and apply new ideas. It is regrettable that these ideas aren't being appropriately applied in the real world. For those living in remote areas, this can be challenging and expensive. The fundamental and important machinery used in agriculture for maximum production is the multipurpose agricultural or farming machine. Because of the labour-intensive nature of the conventional method of weeding, seeding, and pesticide spraying, labour is in short supply, which affects many Indian farmers.

Keywords: rotating, autonomous, seedlings, and seed sowing

1. INTRODUCTION

Overview In India, agriculture is the main industry. In certain regions of Southern India, agriculture has a longer history dating back to the Indus Valley Civilization. India currently leads the world in agricultural productivity. Special vehicles are used extensively in a variety of industries, including industrial, medical, and military applications. Their productivity in the agricultural sector is steadily rising. A few of the main issues facing Indian agriculture are the growing cost of inputs, the scarcity of skilled labor, the lack of water resources, and crop monitoring. Agriculture used automation technologies as a solution to these issues. The use of automation in agriculture may allow farmers to work less. Vehicles for the weeding and seeding procedures are being developed.

Features

1. ROBOTIC SEED BOWER.
2. ROBOTIC WATER SPRINKLER.

3. ROBOTIC CUTTER
4. ROBOTIC FORWARD
5. ROBOTIC REVERSE
6. ROBOTIC LEFT TURN.
7. ROBOTIC RIGHT TURN.

2. PART EXPLANATION

- A. Solar Panel



Fig 1

Solar cells used in satellites are referred to as photovoltaic (PV) cells. An array of twenty-watt solar panels is used in this project. The solar panel produces voltage and current of 21 V and 1.10 A, respectively. The solar panel weights approximately 2.5 kilograms. The total number of cells in the solar panel is 36. The solar panel utilized in this project was

- B. C. Motor



Fig 2

DC motor works by transforming electrical energy into mechanical energy, usually by means of the interaction of

current-carrying conductors and magnetic fields. The process the process of changing mechanical energy into electrical energy is completed by dynamos, generators, and alternators. Electric motors of several kinds can function as generators and vice versa. A DC motor takes current and voltage as inputs and produces torque, or speed, as an output.

C. Android (Smart Phone) & Wi-Fi Based Remote Control



Fig 3

What is an Android device?

Android is a mobile operating system that is powered by the Linux kernel and is primarily intended for touchscreen devices like tablets and smartphones. Android's UI is based on direct manipulation, whereby on-screen items are manipulated by touch inputs that roughly translate to actions in the real world, such as swiping, tapping, pinching, and reverse pinching. hardware inside.

Symbiosis was surpassed by Android to become the most popular smartphone platform globally in the fourth quarter of 2010. Technology firms who need a ready-made, affordable, lightweight, and configurable operating system for high-tech devices are fond of Android. Although it was originally intended for phones and tablets, it has also been utilized in digital cameras, game consoles, televisions, and other devices. The open nature of Android

Network Connectivity

It supports wireless communications

using: GSM mobile-phone

technology

4G

Edge

802.11 Wi-Fi networks

D. Resistors

An electrical component with two terminals, a resistor generates a voltage across its terminals in proportion with relation to the electric current passing through it, as per Ohm's law: V Equivalent to IR

A common component of most electronic devices, resistors are parts of electrical networks and electronic circuits. Aside from resistance wire (wire composed of an alloy with a high resistance, like nickel/chrome), practical resistors can be built of a variety of compounds and films.

E. Transistor

A transistor is made up of two p-n junctions, which are created by sandwiching n- or p-type semiconductors between two pairs of the opposing kind.

As a result, there are two varieties of transistors, specifically:

n-p-n transistor

p-n-p transistor

F. LED

A light source made of semiconductors is called an LED. LEDs are being used more and more for lighting and as indication lamps in many gadgets. Early LEDs were first commercially available in 1962 as a useful electronic component.

They produced low-intensity red light, nonetheless, more current models have extremely high brightness and are available in visible, ultraviolet, and infrared wavelengths. In figures, the internal components and structure of a led are displayed.

G. Wheel

A wheel is a piece of machinery that revolves around an axle. One of the key parts of the wheel and axle, one of the six fundamental machines, is the wheel. In addition, wheels can be utilized as flywheels, steering wheels, and ship wheels.

When wheels and axles work together, large things can be moved with ease, making it easier to transport or move while carrying a load or operating machinery. Applications related to transportation provide common examples. Through the use of axles to facilitate rolling together, a wheel significantly minimizes friction. Wheels require the application of an external force or the

H. Micro Controller

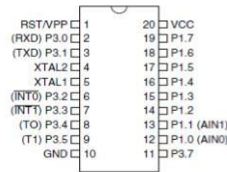
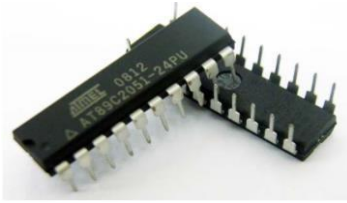

The AT89C2051 is an 8-bit CMOS microprocessor with low voltage and high performance. It can read and write data to Flash read-only memory (PEROM) with a capacity of 2K bytes. The device is made using high-density nonvolatile memory technology from Atmel and is compatible with the industry-standard MCS-51 instruction set. The Atmel AT89C2051 is a very flexible and reasonably priced microcomputer that integrates Flash and a flexible 8-bit CPU into a single monolithic chip, making it ideal for a variety of embedded control applications.

1. Compatible with MCS®-51Products
2. Two 16-bit Timer/Counters
3. 2K Bytes of Reprogrammable Flash Memory
4. Six Interrupt Sources
5. 2.7V to 6V Operating Range
6. Programmable Serial UART Channel
7. Two-level Program Memory Lock
8. Direct LED Drive Outputs
9. 128 x 8-bit Internal RAM
10. On-chip Analog Comparator
11. 15 Programmable I/O Lines
12. Two 16-bit Timer/Counters
13. Six Interrupt Sources
14. Programmable Serial UART Channel
15. On-chip Analog Comparator
16. Direct LED Drive Outputs

You can send and receive serial data wirelessly using this module. It provides transparent two-way data transfer by simply replacing wired serial connections. To link an MCU or embedded project to a PC for data transfer, you can easily utilize it to substitute serial ports. Main module operates on 3V only. This board operates on 5V and has LED indication and 3V regulator onboard.

- a. Applications-wireless Telemetry
 - b. Remote control & automation system
 - c. Remote Data Logging
 - d. Robotics
 - e. Sensor Networks
 - f. Remote Programming
- I. Spdt Relay – 12V

It closes the voltage less point of contact while the remote control worksto manage the equipment outside. The relay takes advantage of the reality that when electricity flows through a coil, it becomes an electromagnet. The electromagnetic coil attracts a steel plate, which is attached to a switch. So the switch's motion (ON and OFF)

is under the direction of the current flowing to the coil, or not, respectively. A very useful feature of a relays that it has the ability to electrically isolate different parts of a circuit. It will allow a low voltage circuit (e.g. 5VDC) to switch the power in a high voltage circuit (e.g. 230 VAC or more). The relay operates mechanically, so it cannot operate at high speed.

3. SOFTWARE OVERVIEW

The following software is being used to implement this project:

- Express PCB is used for circuit design;
- PIC C compiler is used for compilation;
- Proteus 7 (Embedded C) is used for simulation.

Express PCB

In order to make design modifications as needed, breadboards are an excellent tool for equipment prototype. Nevertheless, the end result of a project should preferably have a clean PCB, minimal cables, and the ability to withstand a shake test. A proper PCB is not only more organized, but it is also stronger since there no unsecured cables.

The Express PCB Software is employed to design PCBs exclusively for the firm Express PCB's manufacturing (other PCB manufacturers do not accept files from Express PCB). Although it is really simple to use, there are a few restrictions.

WORKING OF PCB

How it's work?

Remote operation is achieved by any smart-phone/Tablet etc., with Android OS, upon a GUI (Graphical User Interface) based touch screen operation, interfaced to the microcontroller of 8051 family. The program on the microcontroller serially communicates with Bluetooth device to generate respective output according to the input data (sent from Android application device) to operate a set of relays through a relay driver IC. The loads are interfaced to the command unit through the relays. The system utilized in existing domestic area for either operating the loads through conventional switches.

See the block diagram of unite. Is based on AT89C2051 (20 Pin) Micto the controlro controller.

The complete projects divided in different interfacing Part

1. Main micro controller unite, use as CPU
2. Bluetooth Module Interfacing
3. Relay driver & Relay Section
4. Controlled Power Source

4. WORKING OF AGRO MACHINE

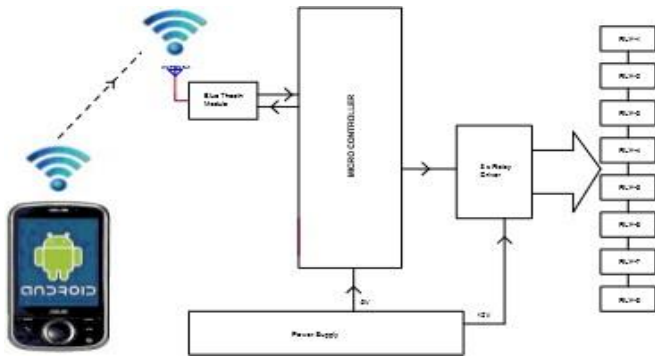

Fig 5

The working of IoT based agricultural machine is easy to operate. The software developer to create android app which is installed in the mobile, tablet or personal laptop. These apparatuses are those that are to be control the agricultural robot. The program which is dumped into the microcontroller in the Printed Circuit Board (PCB). These PCB consist of WI-FI module which is going to switch on this WI-FI hotspot. By using Android Phone or other gadget make connection to this WI-FI hotspot, through which control the machine.

Power supplies the entire part of the machine i.e. PCB, motor and pump. When signal is generate by the gadget through WI-FI, this signal is transmitted to the WI-FI module in the PCB. The signal under processing making signal strong, amplification etc. Then this signal goes from the microcontroller

IC where the data modification takes place. The signal goes to the Relay Driver IC. According to the signal generated the controller generate signal to make Relay ON/OFF. These relay is affixed to the Motor for the Application. The Relay regulates these motors.

5. ALGORITHM FOR ROBOT CONTROL

The Robot's workflow is described in the steps that follow.

Fig. 6 displays the steps' flowchart.

1. 1. Setting up the setup as necessary.
2. Use the internet to link the web page and the robot.
3. The robot ought to await a signal from the webpages it has been sent. Until the robot receives a signal from the web page, it will not operate.
4. The robot will move forward, backward, left, and right if a movement signal is received.
5. In particular, it will carry out tasks like planting seeds, trimming grass, applying pesticides, and harvesting fruit if a signal is received for mechanisms.

6. All of the robot's mechanics and motions will be disabled in the event that a global stop signal is received.

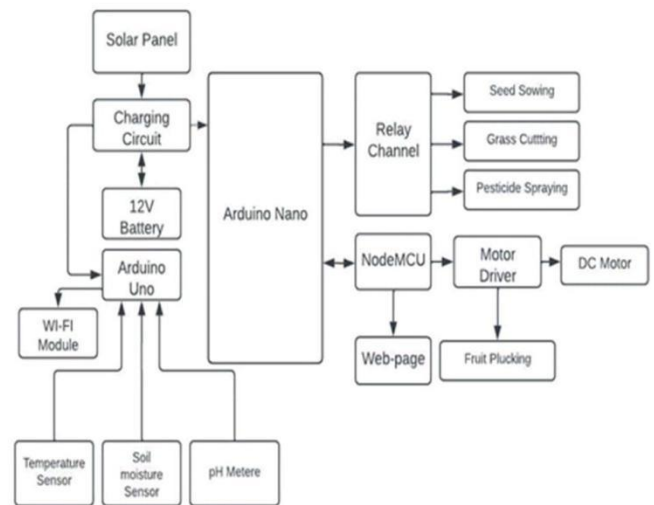

Fig 6 Flowchart of the system.

2. RESULTS AND DISCUSSION

Seed sowing:

Robots carry out various agricultural tasks, including planting seeds, applying pesticides, mowing the lawn, harvesting fruit, determining the soil's nutritional content, and providing irrigation. With the use of the webpage and user commands, these processes are carried out. The user can communicate with Adriano by sending signals through the internet and IoT module, indicating that they want to perform a particular task.

One agricultural technique for planting seeds is called seed sowing. That's the first stage of growing things. The plowing process needs to be done prior to planting seeds. This involves using a DC motor and funnels to sow seeds. The process of seed sowing is done in the formed field utilizing a slider crank mechanism. Though tedious and repetitive, the process is completed.

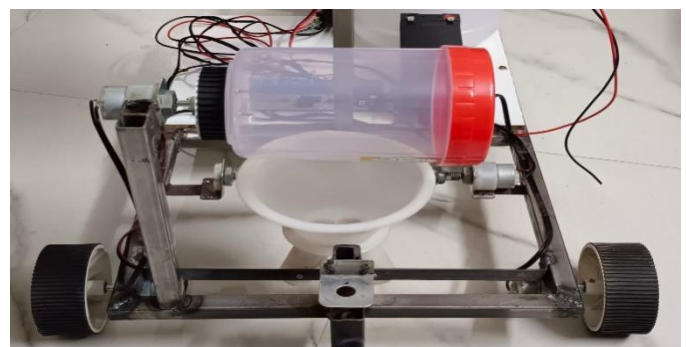

Fig 7 Seed Sowing.

Grass cutting:

An agricultural practice called grass cutting is used to get rid of undesired grass from fields. This robot cuts grass with a 1000 RPM (Revolutions per Minute) DC motor. The grass cutting mechanism is seen in Fig. 8

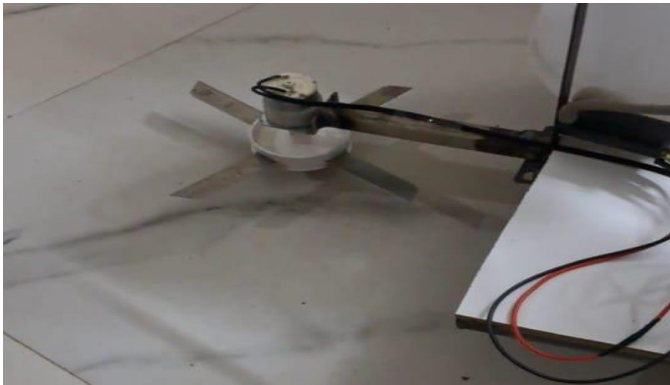

Fig 8 Grass Cutting.

Pesticide Spraying:

To do this process, you'll need a 2-liter container, a 12-volt submersible pump, and a funnel. A container that also has a submersible pump houses the insecticide and water. Pump and pipe are connected, and the pipe and micro-sprinkler are connected via valves. The technique of pesticide spraying is illustrated in Fig. 9.



Fig 9 pesticide spraying

Ploughing:

We made three ploughs with a 20-degree rake angle and 170 mm between them to make plowing easier. To control its movement, we used a rack and pinion system. Mild steel is used to make ploughs because it is stronger than aluminum.



Fig.10 Ploughing

3. MODEL

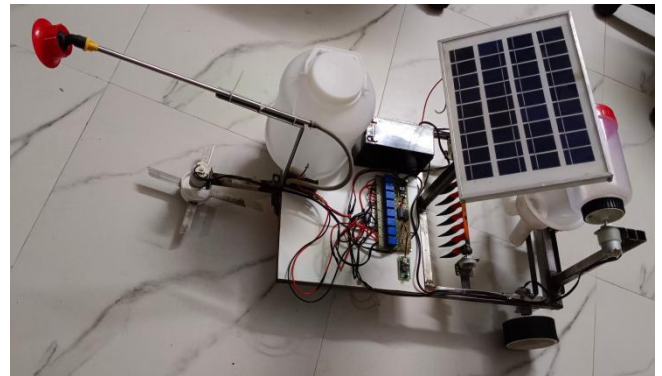

4. CONCLUSION

In actuality, our versatile farming tools are suitable for weeding, leveling, planting, fertilizing, and tilling. Each piece of equipment is connected so that it may be readily joined with fasteners to the necessary length and field operating criteria at any step of the agricultural process. Using a combination of mechanical engineering concepts and agricultural expertise, our team has effectively increased yield while lowering labor costs and effort. The entire notion of multifunctional equipment is novel, patented, and workable in practical settings.

The top concentration of our design is the cost and operational ease in case of small farm units. This multipurpose agro equipment is thus designed to reduce the cost of harvesting, spraying and seed feeding. In the development of multipurpose agro equipment we utilize the past data and techniques. In this way the design of multipurpose agro equipment is safe. Such human powered machine systems will help to a great extent in improving the production per acre and increase profitability of small and middle class farmers. A new type of multipurpose mechanism is fabricated which is different from other machines and will work on unconventional energy source that can only be used by humans. These systems are crucial in Asian nations since nearly all of them struggle with power and electrical

shortages, which cause load shedding in rural regions, particularly in India, to last for twelve to fourteen hours. As a result, it is necessary to create locally manufactured, multifunctional agricultural equipment.

5. SCOPE FOR FUTURE WORK

Task We can create agricultural equipment that is versatile and long-lasting by optimizing its strength and quality. The equipment can also be configured as tractor-powered equipment by adding hydraulics, changing the gear configurations, and making a few small tweaks.

By using sensor in the machine are used to sense the moisture content in the soil, pH of the ground, level of water, pesticide spraying, adjustment of cutter. These are possible by using Sensor.

We can create multipurpose agricultural equipment that will last a lifetime by optimizing the equipment's strength and quality. The equipment can also be converted to run on tractors by adding hydraulics, changing the gearbox layout, and making a few other small alterations.

6. REFERENCES

1. Gulam Amer, S.M.M. Mudassir, M.A Malik3 , "Design and Operation of Wi-Fi Agribot Integrated System", IEEE International Conference on Industrial Instrumentation and Control, May 2015
2. Fernando A. Auat Cheein and Ri Cardo Li, "Agriculture Robotics: Unmanned Robotic Service Units in agriculture tasks," IEEE industrial electronics magazine, Sep2013
3. Sajjad Yaghoubi, Negar Ali Akbarzadeh, Shadi Sadeghi Bazargani, "Autonomous Robots for Agricultural Tasks and Farm Assignment and Future Trends in Agro Robots", International Journal of Mechanical & Mechatronics Engineering ,June 2013
4. Pavan.C, Dr. B. Sivakumar,"Wi-FiRobotVideo Surveillance Monitoring" System International Journal of Scientific & Engineering Research, August-2012
5. Tijmen Bakker, Kees van Asselt, Jan Bontsema, Joachim Muller, Geritt van straten, "A path following algorithm for mobile robots", Springer Science Business Media, Vol.29,pp 85-97,2010
5. Prof. Anuprita Bhosale, Ketan More, Sachin Rahinj, Ajit Pawar."FABRICATION OF WHEEL OPERATED PESTICIDE SPRAYER". International Journal of Scientific & Engineering Research Volume 10, Issue 5, May-2019.
6. Prof. C.J. Shende, Kartik R. Khodke, Himanshu Kukreja, Sumit Kotekar,Nital Kukade. "FABRICATION OF GRASS CUTTER MACHINE". International Journal of Emerging Technologies in Engineering Research (IJETER) Volume 6, Issue 1, January (2018) .
7. Thorat swapnil V, Madhu L.kasturi, Patil Girish V,Patil Rajkumar N "DESIGN AND FABRICATION OF SEED SOWING MACHINE". International Research Journal of Engineering and Technology (IRJET) Volume: 04 Issue: 09 | Sep -2017.
8. B. Ranjitha, M. N. Nikhitha, K. Aruna, Afreen and B. T. V. Murthy, "Solar powered autonomous multipurpose agricultural robot using Bluetooth /android App," in IEEE 3rd International conference on Electronics, Communication and Aerospace Technology (ICECA), pp. 872- 877, 2019, doi: 10.1109/ICECA.2019.8821919.
9. Sunjiv Soyjaudah, and Reshma Banu. "An intelligent report generator for efficient farming." In 2017 International Conferenceon Electrical, Electronics, Communication, Computer, and Optimization Techniques (ICECCOT), pp. 1-5. IEEE, 2017.
10. D. Zermas, H. J. Nelson, et al, "A methodology for the aetection of nitrogen deficiency in corn fields using high-resolution RGB Imagery," in IEEE Transactions on Automation Science and Engineering, vol. 18, no. 4, pp. 1879-1891, Oct. 2021, doi:10.1109/TASE.2020.3022868.