

ADVANCEMENTS IN CRICKET TRAINING: AN AUTOMATED BALL-THROWING MACHINE FOR VARIED BOWLING DELIVERIES

Sahil Garud¹, Manali Choudhari², Aditya Chakkarwar³, Dhiraj Badshe⁴, Nishigandha Darekar⁵
Vrushali Bhalerao⁶

^{1,2,3,4,5}Department of Mechanical Engineering, PCCOE Pune, India

⁶Assistant Professor, Department of Mechanical Engineering, PCCOE Pune, India

Abstract - Cricket is the most dominant sport played, especially in India. Training centers for cricket are filled with numerous cricket ball-throwing machines, which are quite expensive, and few functions are manually handled. Here is an attempt to build a cricket ball-throwing machine that is completely automated and cost-effective. The main purpose of the study is to design and develop a ball-throwing machine along with modeling the machine. The machine will be able to adjust to different pitch conditions and will be able to deliver different forms of bowling along with the height adjustment mechanism. To deliver cricket balls ranging from 40 kmph to 130 kmph, two motor mechanisms are used upon which grooved wheels are mounted.

Key Words: Cricket, Cost-effective, Ball throwing machine, bowling variations, motor mechanisms.

1. INTRODUCTION

Cricket a popular sport which is played by many countries worldwide [1], enjoys unparalleled popularity, particularly in cricket-crazy nations like India. As sport evolves, there is an increasing demand for innovative training methods that enable players to enhance their skills and grasp various aspects of the game. In modern training facilities, cricket ball-throwing machines have become indispensable tools for players seeking to improve their batting and bowling abilities through precise and consistent deliveries. However, existing machines often come with limitations such as manual operation and high costs. This study seeks to address these challenges by developing a cricket ball-throwing machine that surpasses conventional solutions available in the market. The primary objective is to create a fully automated and cost-effective machine capable of delivering various types of bowling and adapting to diverse pitch conditions. Additionally, the machine will feature a height adjustment mechanism to accommodate players of different statures and skill levels, making it a

versatile and indispensable training companion. At the core of this innovative design lies the integration of two motor systems with strategically positioned grooved wheels. This combination allows the machine to deliver cricket balls at various speeds, from a comfortable 40 mph to a challenging 130 kmph. The precision and consistency provided by these motorized mechanics will assist players in honing their reflexes, refining their shot selection, and improving their overall batting proficiency.

Moreover, the incorporation of a ball positioning system enables players to practice various delivery styles, simulating the actions of fast bowlers, spinners, and swing bowlers. This feature not only enhances a batsman's ability to read the ball but also provides bowlers with valuable opportunities to master different variations and deceive batsmen effectively.

2. DESIGN CALCULATIONS AND ANALYSIS

The Design calculation of the ball throwing mechanism is done considering the mass of the ball, kinetic energy as well as the rotational energy of the ball to be thrown.

2.1 DESIGN CALCULATION VALUES

Design calculation for cricket ball throwing machine involves motor specifications, wheel diameter and grooving, ball speed range, etc.

A. Motor Power Calculated Values: Motor calculation for cricket ball throwing machines is essential in designing as it determines the motor's capacity to achieve the desired ball speeds and deliver consistent and accurate deliveries. The values are as following:

- Mass of the ball (M): 150 gm.
- Maximum velocity of the ball: 151.2 kmph (42m/s)
- Kinetic Energy of the ball (KE) = 132.3 Nm
- Kinetic Energy supplied by one wheel = 66.15 J

B. Wheel Calculated Values: In wheel calculation wheel size, rotational speed and grooving are considered to achieve the desired ball speed and types of deliveries for cricket ball throwing machine. The Rotational Energy of the wheel is given by, $R.E. = (1/2) I (\omega_1^2 - \omega_2^2)$

$$M = 0.3144 \text{ kg}$$

$$I_{\text{wheel}} = 0.004472 \text{ kg}\cdot\text{m}^2$$

Initially, we know that $\omega_1 = 251.3 \text{ rad/sec}$ and $R.E. = 66.15 \text{ J}$

So, substituting in the above equation we can calculate $\omega_2 = 250 \text{ rad/sec}$ So, we can see that the angular velocity gets reduced by a factor of 1.0179. In a similar manner, we reduce the rpm of the wheels by some amount in each turn and calculate the velocity of the ball for each case.

C. Obtain off spin and leg spin at different output speeds: The speed of the above two motors will be adjusted accordingly to obtain the required spin. If the rpm of the left-hand side motor is more than the off-spin is produced for a right-handed batsman and if the right-hand side's motor speed is more than the leg-spin will be there.

The following, Figure 1, shows the ball variations that are considered for the design and analysis of the cricket ball throwing machine. Ball machines have the same benefits for cricket players irrespective of their performance level. Amateurs and professionals alike enjoy the same perks in a practice session. Many professionals relish the success of enhancing their game by practicing with a bowling machine.

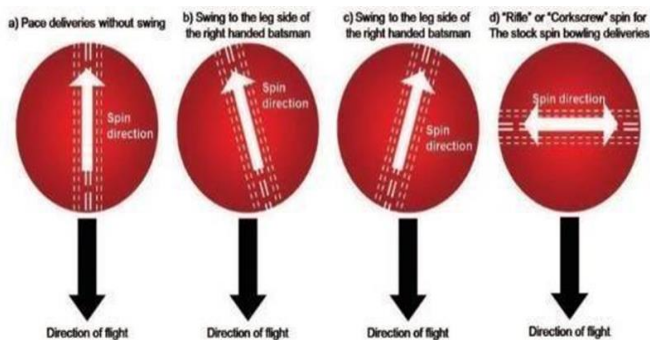

Fig -1: Ball Variations [3]

D. Stand Calculations Values:

Calculation of the stand for the cricket ball-throwing machine is essential for stability, adjustability, and user-friendliness.

Height of the stand = 4ft 1 inch = 1244.6 mm,

Type of rod = hollow square cross section rod

Mass of the mechanism = 5 kg,

Length of the stand = Breadth of the stand = 250 mm,

Thickness of rod=5mm

Force on a single leg of stand = $1/3 \cdot m \cdot g = 1/3 \cdot 5 \cdot 9.8 = 16.35 \text{ N}$

Area of Outer section (A1) = (B*T) = 62500 mm²

Area of inner section (A2) = [B' * T'] = 60516 mm²

Total Area under load = A1-A2= 1984mm²

Stress = F/A = 8.241 * 10⁻³ MPa

2.2 STRUCTURAL AND STRESS ANALYSIS

With the help of ANSYS the structural and stress analysis of cricket ball throwing machine is done. It helps to ensure safety, performance optimization, failure prediction, and reliability.

A. Total Deformation:

The overall deformation of the cricket ball throwing machine begins at the center of the base plate which is zero and steadily grows to the end of the base plate, where it reaches its maximum which is 0.00017693m.

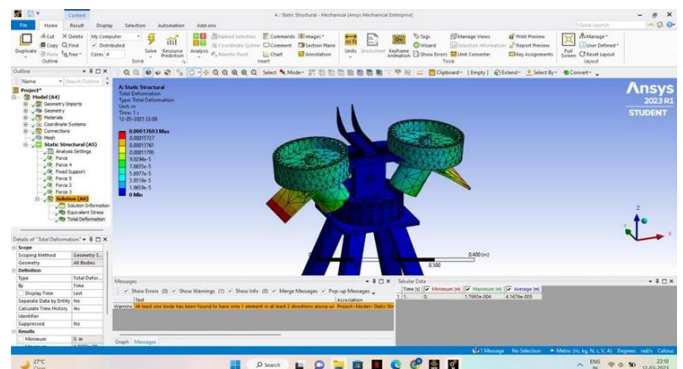

Fig -2: Total Deformation

B. Normal Shear Analysis:

Normal stress analysis aids in identifying areas of the machine that may experience excessive tensile or compressive loads.

The normal stress analysis revealed areas of high-

stress concentration and regions experiencing significant loading. The high-stress regions could potentially be susceptible to failure or fatigue over time. The following figure shows the normal stress analysis of the machine which had been achieved using ANSYS software.

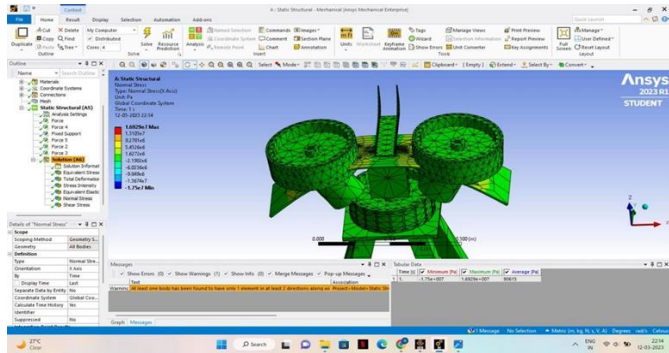

Fig -3: Normal Stress Analysis

C. Stress Intensity:

The stress intensity analysis determines the level of intensity of stress concentrations.

The ball-throwing mechanism has minimal stress throughout the assembly, however, there is a modest increase in stress at the joint between the wheel and the base plate.

The minimum stress throughout the assembly is 0.28983, and the modest increase in stress at the joint is from 1.2655e7 Pa to 3.7964e7 Pa. The following figure shows the stress intensity of the machine which is determined using software ANSYS.

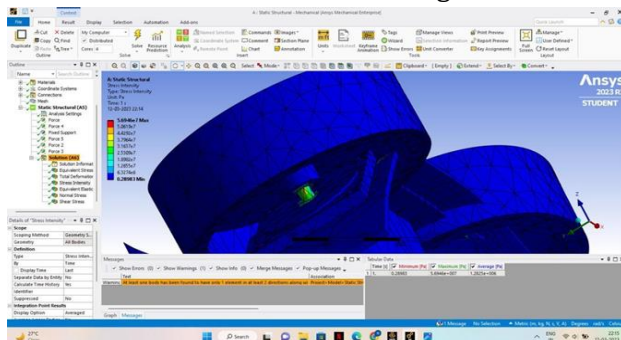

Fig -4: Normal Stress Analysis

3. MANUFACTURING OF THE BALL FEDDER

3.1. BASE PLATE

The base plate is made of Mild steel of grade A36. It also features remarkable corrosion resistance in both interior and exterior conditions. The dimensions of the plate are 500 x 120 mm, having a thickness of 4mm. The base plate is designed in such a way that it will be easy to deliver cricket balls of different dimensions because of the adjustment provided. Its function is that it will be used to mount the motor and the wheel, and it will be used to adjust the distance between the two wheels. The manufacturing process of laser cutting is used to make holes of different dimensions on a solid metal plate.

Design of Base Plate:

The design of the base plate was initially made using the dimensions and the drifting of the base plate. The CAD model was made using CATIA V5. This was helpful in the manufacturing of the base plate. Figure 5 shows us the CAD Model of the base plate. The Base plate was manufactured using Mild steel of grade A36 of thickness 4 mm. The plate was manufactured using a laser cutting machine at Gujar Industries, Pune. Figure 6 shows the actual manufacturing of the base plate.

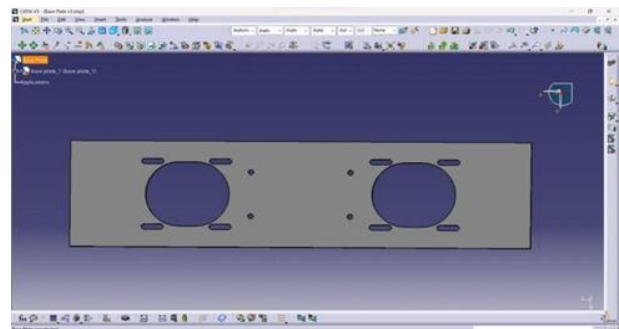

Fig -5: CAD Model of Base Plate

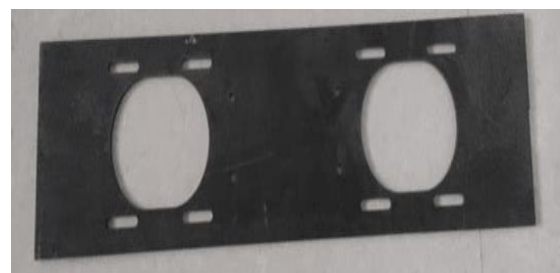

Fig -6: Actual Base Plate

3.2. WHEEL

The wheel material used is ASA - Acrylonitrile Styrene Acrylate. The wheels mounted adjacent to each other will slightly compress the cricket ball entering the machine for its delivery. The wheels are rotated by mounting them on the electric motors. The wheel will be directly joined to the motor shaft. The wheel is manufactured using an injection molding manufacturing process.

The wheel has an outer diameter of 180mm and an inner diameter of 160mm. The width of the wheel is 60mm. The grooves made in the wheel are 5mm in size.

Design of Wheel:

The design of the wheel was made using CATIA V5. It was made using proper dimensions which then was used for manufacturing purposes. Figure 7 shows the CAD Model of the wheel. The wheel was made using ASA - Acrylonitrile Styrene Acrylate which helps in cutting down the weight while keeping the strength and load capacity of the wheel same. Figure 8 shows the actual manufacturing of the wheel.

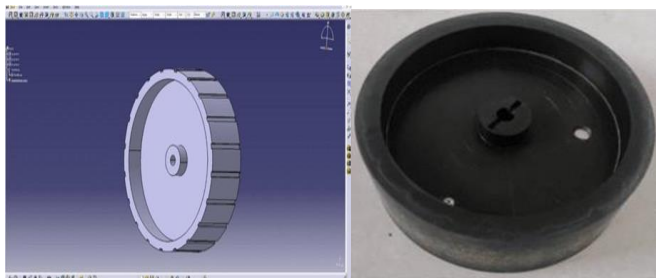

Fig -7: CAD Model of Wheel **Fig -8: Actual Wheel**

3.3. STAND

The stand is made of Mild steel material. The stand is provided with the facility of height adjustment for cricket ball deliveries at different heights. The height of the stand is 1244.83mm. The circular plate at the top is 200mm in diameter. There are in total three legs attached to the circular plate. The angle between the legs of the stand is 120°.

Design of the Stand:

The design of the stand was made using CATIA V5. It was made using proper dimensions which then was

used for manufacturing purposes. Figure 9 shows the CAD Model of the wheel. [5]

The wheel was made using Mild steel material which helps in cutting down the cost while keeping the strength and load capacity of the wheel same. Figure 10 shows the actual manufacturing of the stand.

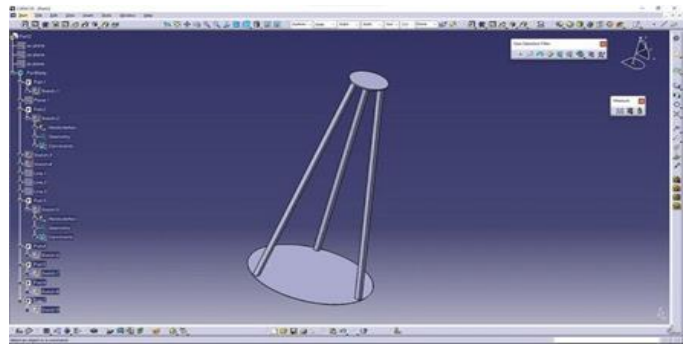

Fig -9: CAD Model of the Stand

3.4. BALL RAMP

When the ball drops from the ball feeder it is dropped upon the ball position aligner. [4] The aligner maintains the position of the ball attained in the feeder. By maintaining the position of the cricket ball, the ball further passes through the wheels and a certain ball delivery is achieved.

Design of the Ball Ramp:

The ball ramp model was made using CATIA V5. The ramp is used to properly position the ball along a fixed path. [4] Figure 11 shows the CAD model of the Ball ramp. The manufacturing of the ball ramp was done in Gujar Industries. The ball ramp was manufactured using a laser cutting machine and then welding the parts together. The actual ball ramp as seen in Figure 12, was made of mild steel of thickness 3mm.

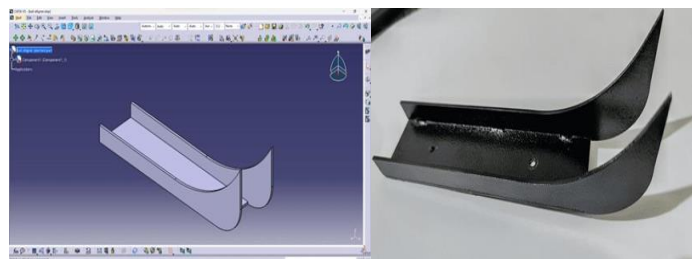

Fig -10: CAD Model of Base Plate **Fig -11: Base Plate**

4.RESULT AND DISCUSSION

4.1 SPEED CHANGE vs PITCHING DISTANCE (keeping angle constant)

Here we kept the angle constant of the ball throwing mechanism and changed the speed of the machine, following results were observed:

- A. With an increase in speed, the pitching point was in between the 4m to 6m slot.
- B. With a decrease in speed, the pitching point was in between the 6m to 8m slot.

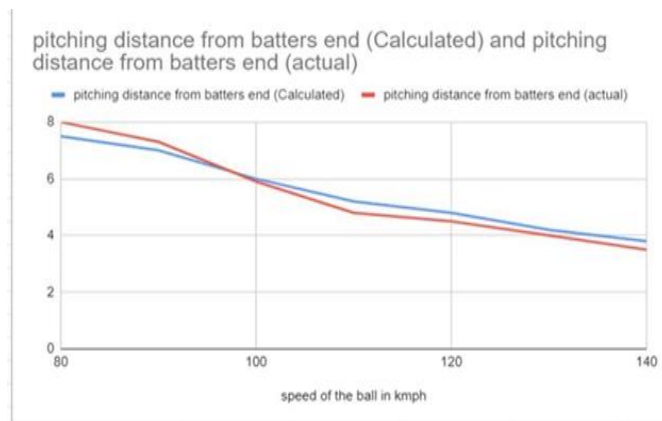

Graph -1: Speed Change vs Pitching Distance

Graph 1 shows that for every increase of 10kmph in “speed of the ball in kmph”, “pitching distance from batter end in meters” decreases by about 0.639m.

4.2 ANGLE CHANGE vs PITCHING LENGTH (keeping speed constant)

Here we kept the speed constant of the ball throwing mechanism and changed the angle of the machine, following results were observed:

- A. With an increase in the angle, the pitching point goes away from the machine.
- B. With a decrease in the angle, the pitching point moved closer to the machine.

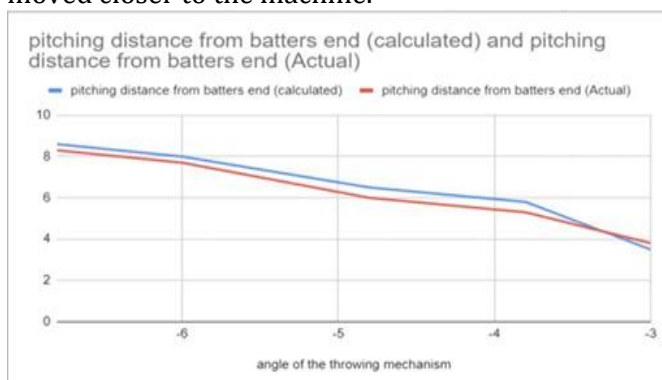

Graph -2: Angle Change vs Pitching Line

Graph 2 shows that for every increase of 1 in the “angle of the throwing mechanism”, “pitching distance from batter end” decreases by about 1.25.

4.3 ANGLE vs PITCHING LINE

Here we kept the speed constant of the ball throwing mechanism and changed the horizontal angle of the machine, the following results were observed:

- A. When the angle takes a negative value (left of middle stump) ball was observed to be pitching in lines outside the off stump (for a right-hander batter).
- B. When the angle takes a positive value (right of middle stump) ball was observed to be pitching in lines outside the leg stump (for a right-hander batter).

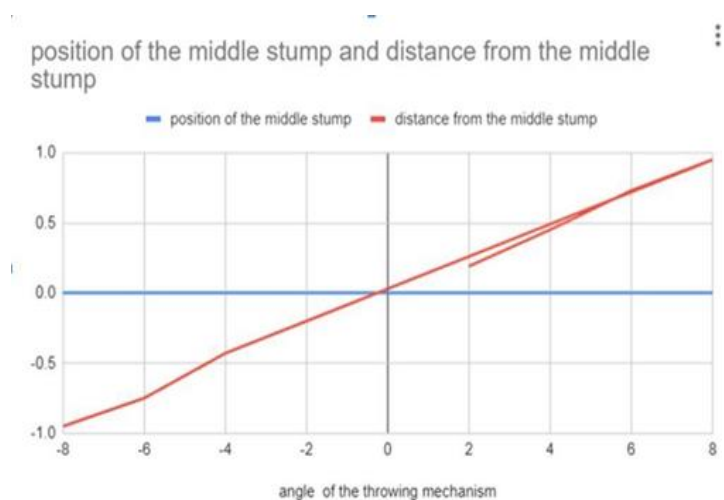

Graph -3: Angle vs Pitching Line

Graph 2 shows that for every increase of 10 in “angle of the throwing mechanism”, “distance from the middle stump” increases by about 1.18m.

4.4 SPEED vs RPM. Of WHEEL

Here we change the speed ball throwing mechanism and observe the change in the RPM of the wheel.

- A. With an increase in the speed of the bowling machine, the RPM of the wheels increases (and vice versa).
- B. At the lowest speed value, 40, the lowest value for the “Rpm of wheel” was observed (1201).

Rpm of left wheel vs speed

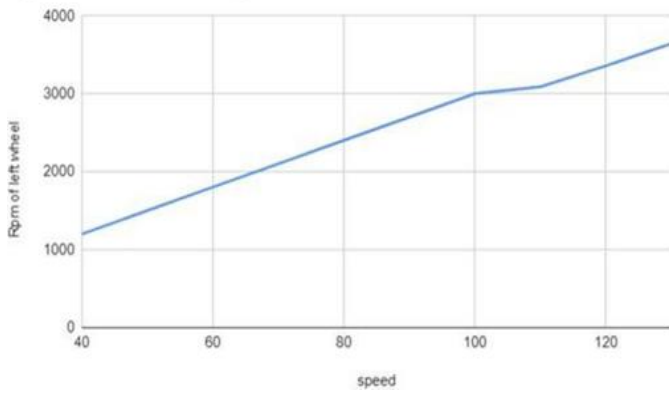

Graph -4: Speed vs RPM of Wheel

Graph 4 shows that for every increase of 10 in “speed”, “Rpm of the wheel” increases by about 266.

4.5 RPM. OF LEFT AND RIGHT WHEEL vs SPEED OF BALL (FOR OFF SPIN)

Here, the Rpm of the wheel was changed to observe different variations of spin at different speeds of the ball delivery. The following results were observed:

A. Spin was observed at delivery speeds below 105kmph.

B. When the Rpm of the left wheel was greater than the right wheel, an off spin was observed. Where 40kmph had the lowest values for “Right wheel rpm” (250) and “Left wheel Rpm” (2303).

C. When the Rpm of the right wheel was greater than the left wheel, leg spin was observed. Where 40kmph had the lowest values for “Right wheel Rpm” (2314) and “Left wheel Rpm” (200).

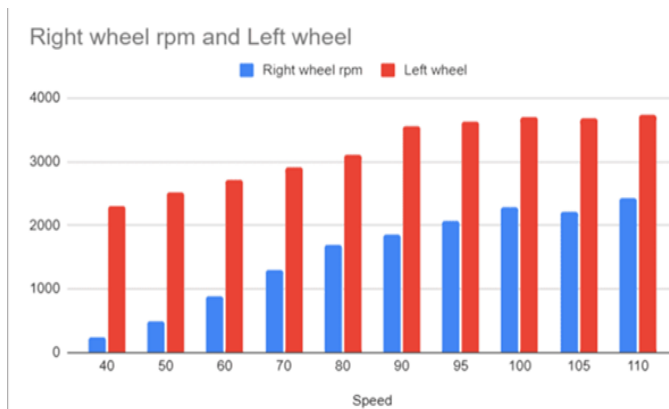

Graph -5: RPM Of Right and Left wheel vs Speed (off spin)

Graph 5 shows that for every increase of 10 in “Speed”, “Right wheel rpm” increases by about 321.

Right wheel and Left wheel

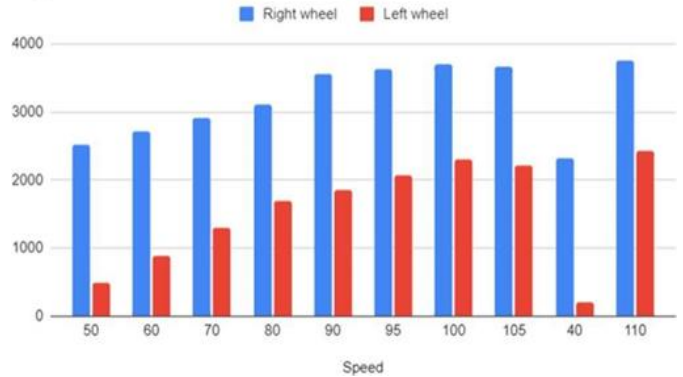

Graph -6: RPM Of Right and Left wheel vs Speed (leg spin)

Graph 6 shows that for every increase of 10 in “Speed”, “Right wheel rpm” increases by about 222.

5.CONCLUSION

After conducting the literature survey, design calculations and manufacturing of different parts, the ball throwing machine was developed using various manufacturing techniques such as molding, welding, rubber coating, laser cutting, drilling, grinding, and others. After testing the machine and taking observations, the following conclusions were drawn.

1. The machine works in perfect condition for 45 mins regularly. The machine performed accurately with slight variations at high speed and accuracy was observed to increase at lower speed.
2. With the change in the angle of the throwing mechanism different pitching points were obtained. When the angle was increased the pitching point was going away from the machine and vice versa.
3. The ball is bowled from a speed of 40 kmph to 130 kmph.
4. Changes in the rotations per minute (rpm) of the wheel result in an increase and decrease in the ball speed.
5. With changing the speed of the single wheel of the ball spin was observed.

Through these observations, it was evident that the ball throwing machine performed very well, demonstrating variations in speed, accuracy, pitching points, and spin generation based on adjustments made to the angle and RPM.

6. REFERENCES

- [1] Abhijit Mahapatra, Avik Chatterjee, Shibendu Shekhar Roy, Modeling and Simulation of a Ball Throwing Machine, NaCoMM-2009-MMRAIAAM20, December 17-18, 2009.
- [2] Mohammed Asif Kattimani, Ahmed Raza, Syed Ameer, Design and Fabrication of Cricket Ball Launching Machine, Mantech Publications, Journal of Industrial Engineering and Its Applications Vol 4 Issue 3, 2019.
- [3] Tara Singh Thakur, K Srinivasa Chalapathi, Ibrahim Syed, Integrated Novel Multi-Game Ball Throwing Machine: Design and Fabrication, International Journal of Scientific & Engineering Research Volume 10, Issue 5, May-2019 ISSN 2229-5518, May-2019.
- [4] L Justham and A West, Design, and development of a novel, integrated bowling machine for cricket, JSET50 Proc. IMechE Vol. 223 Part P: J. Sports Engineering and Technology, 29 June 2009.
- [5] Abhishek Patra Singh, Anuj Kumar Jain, Parteek Mahajan, Design and Fabrication of a Ball Projecting Machine, International Journal of Advance Research and Innovation, September 2016.
- [6] V. B. Bhandari, *Machine Design Data Book*, 2nd Editio. Mc Graw Hill, 2019. Accessed: Jul. 26, 2023. [Online]. Available: <https://www.mheducation.co.in/machine-design-data-book-9789353166304-india>
- [7] V. B. Bhandari, *Design of machine elements*. Tata McGraw-Hill, 2007. Accessed: Jul. 26, 2023. [Online]. Available: https://books.google.com/books/about/Design_of_Machine_Elements.html?id=f5Eit2FZe_cC